



HO, HO, HO!

È la grande notte di Babbo Natale e la famiglia che vive in questa casetta accogliente si sta preparando per il suo arrivo! I biglietti di auguri sono stati prelevati dalla cassetta delle lettere, la tavola è stata apparecchiata, i regali sono stati incartati e i biscotti e il latte sono pronti per sfamare e dissetare il barbuto e gioviale gentiluomo. Non deve far altro che calarsi attraverso il comignolo e condividere un po' di allegria natalizia!





Chris McVeigh
LEGO® Designer

IL DESIGN TEAM

Questo è il secondo set che il LEGO® Designer Chris McVeigh ha creato per la Winter Village Collection, quindi è sulla buona strada per diventare lo specialista dei set natalizi del design team: *"Il Natale è sempre un momento magico per la mia famiglia. È stato divertente inserire alcune delle nostre tradizioni ed esperienze in questo set, dal nuovo biscotto natalizio ai regali nascosti"*.

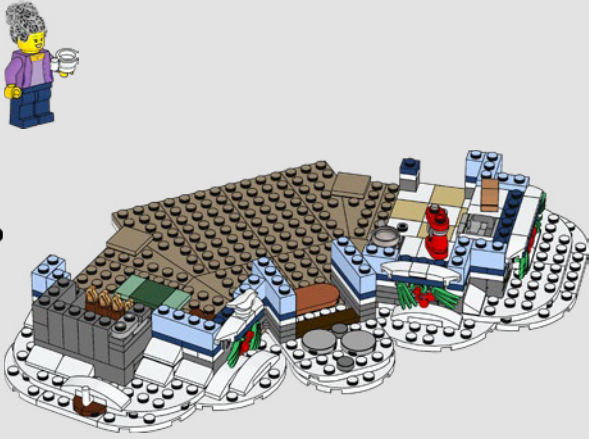

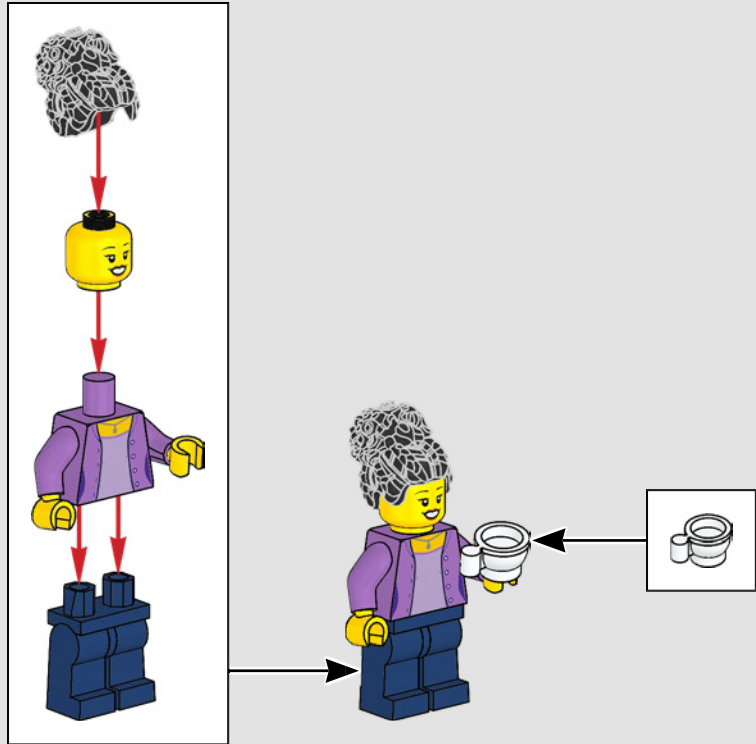

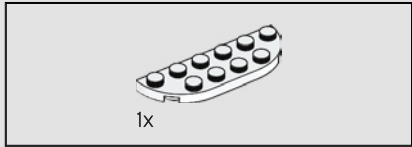

1

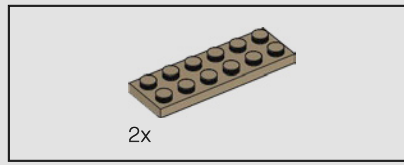
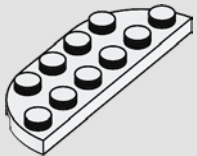

2

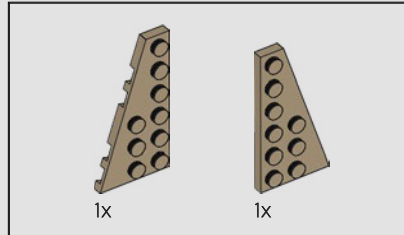
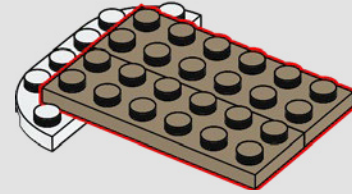

3

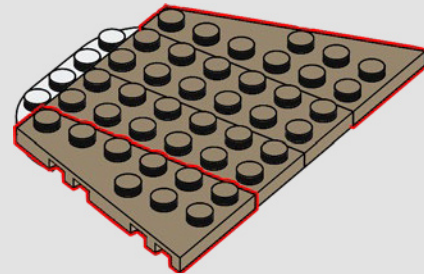

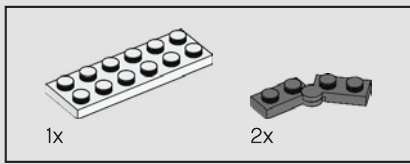

4

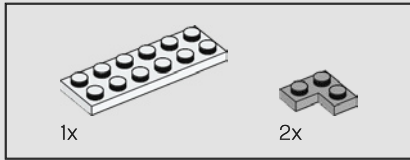
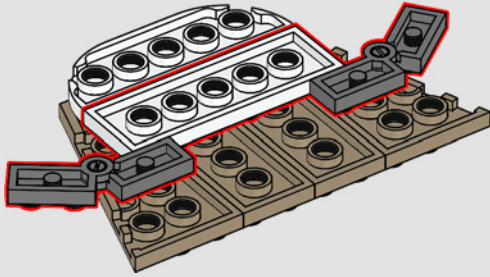

5

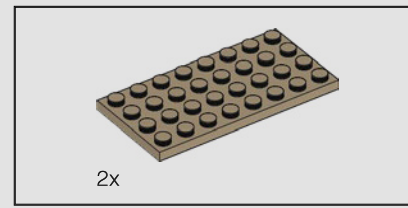
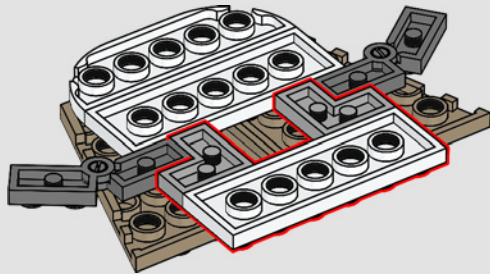

6

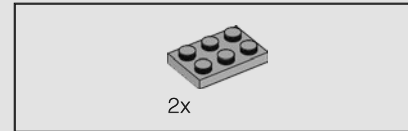
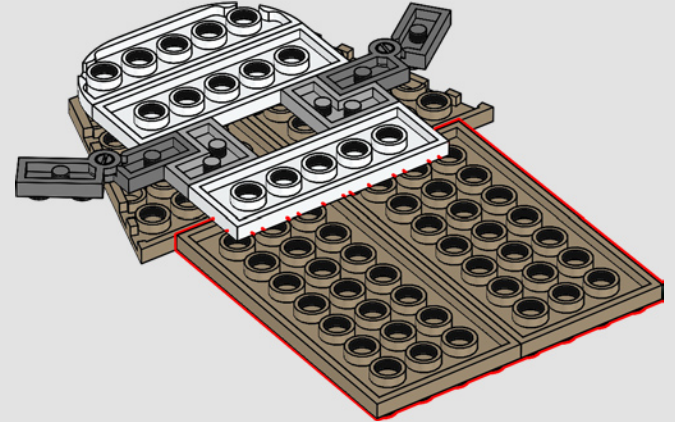

7

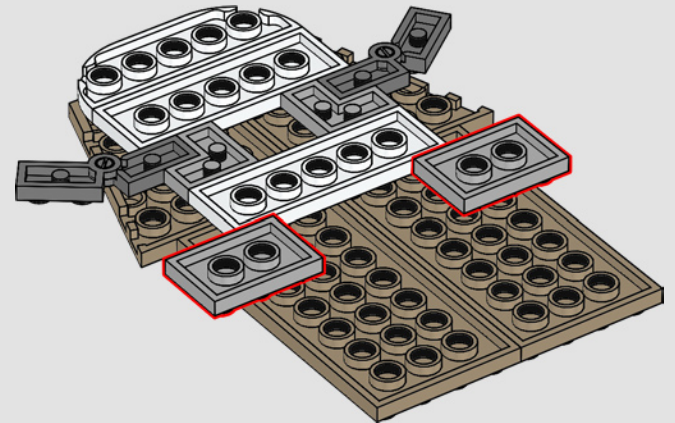

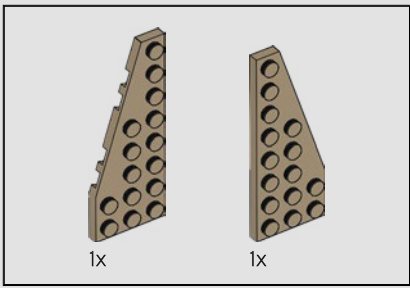

8

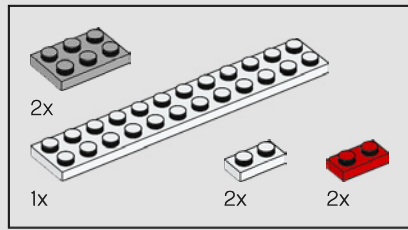
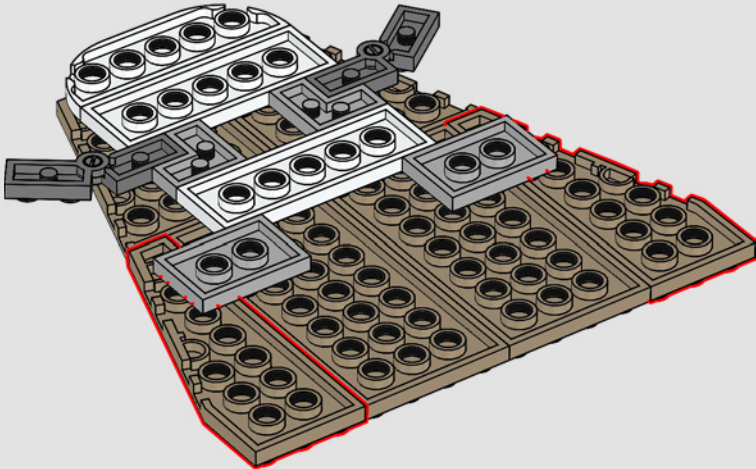

9

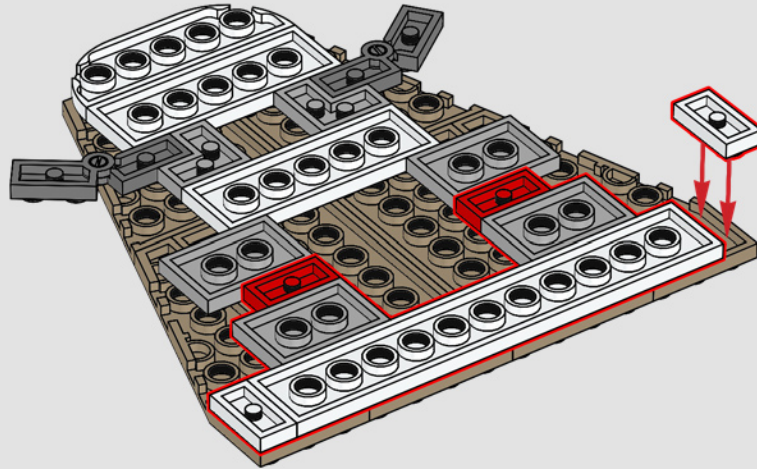

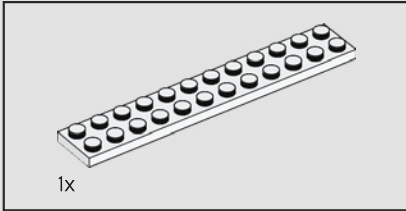
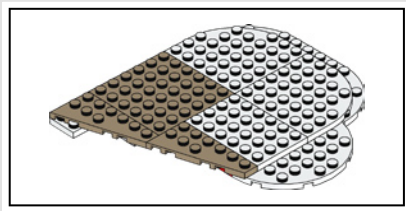

1x

10

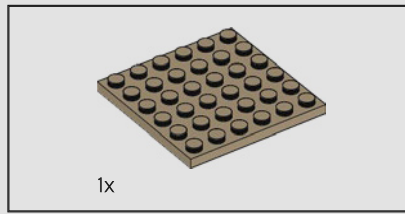
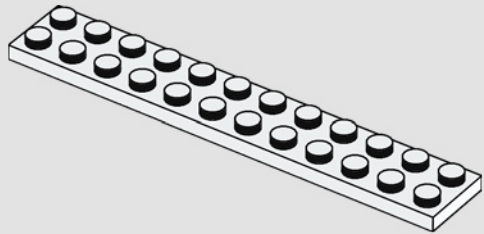

1x

11

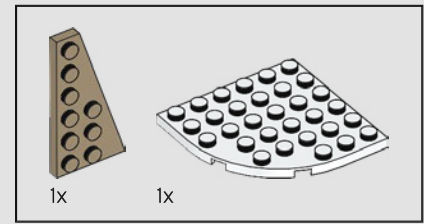
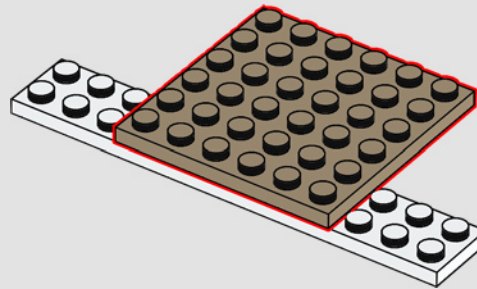

1x

1x

12

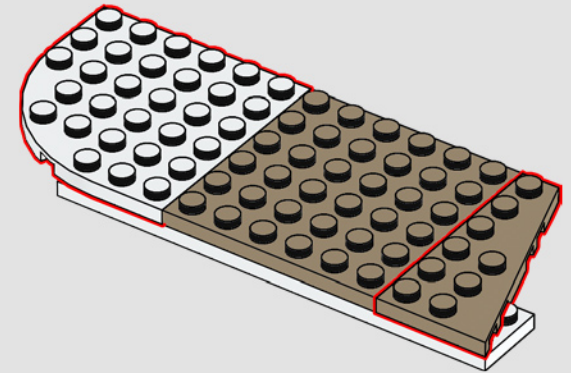

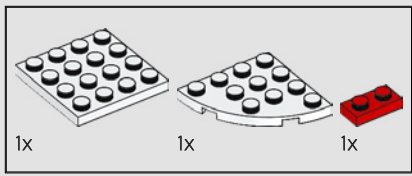

13

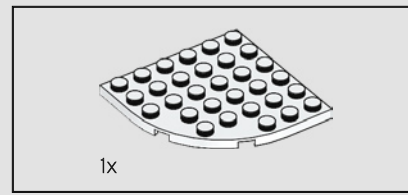
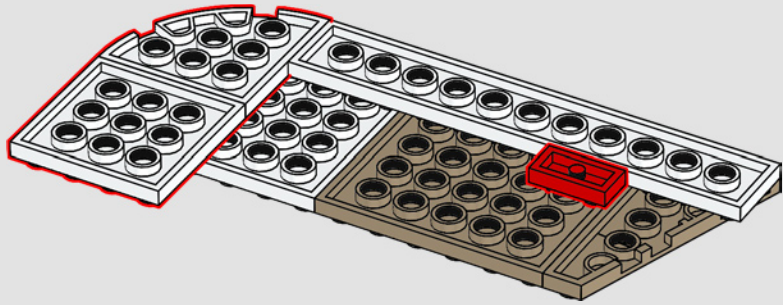

14

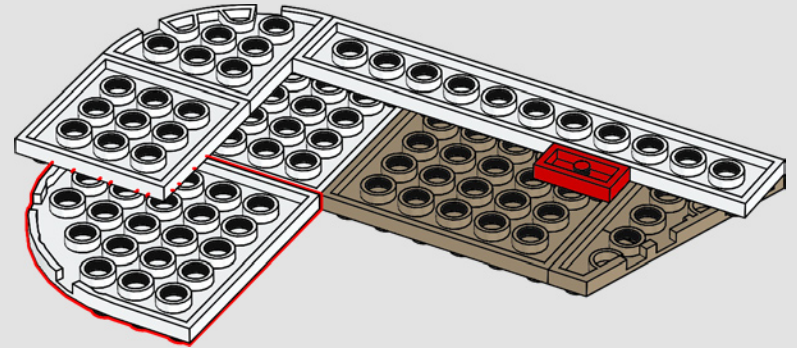

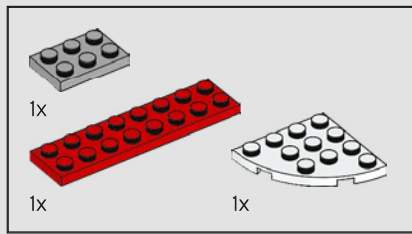

15

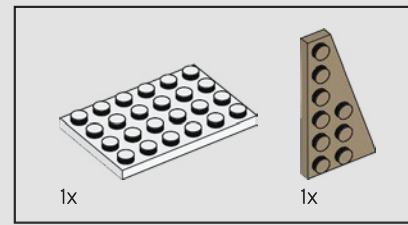
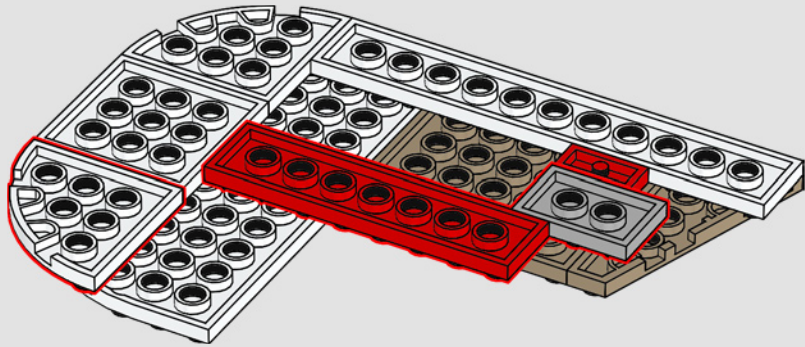

16

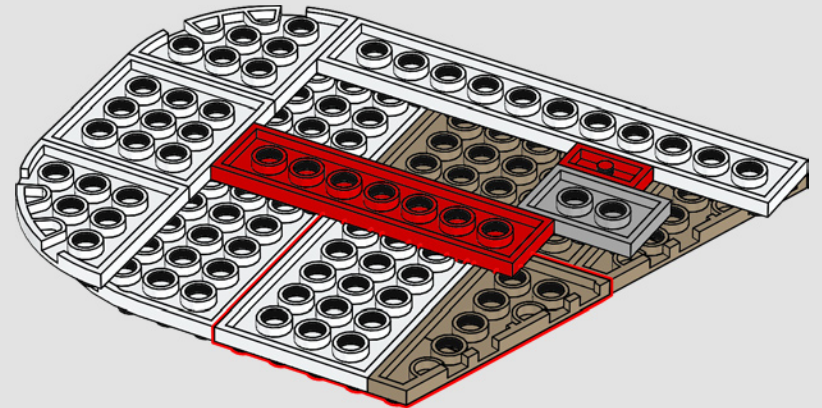

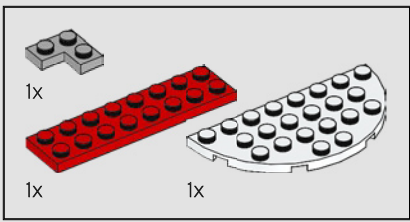

17

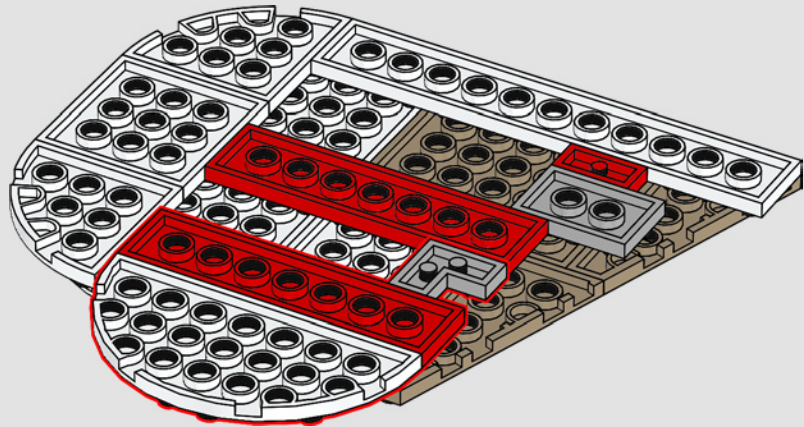

18

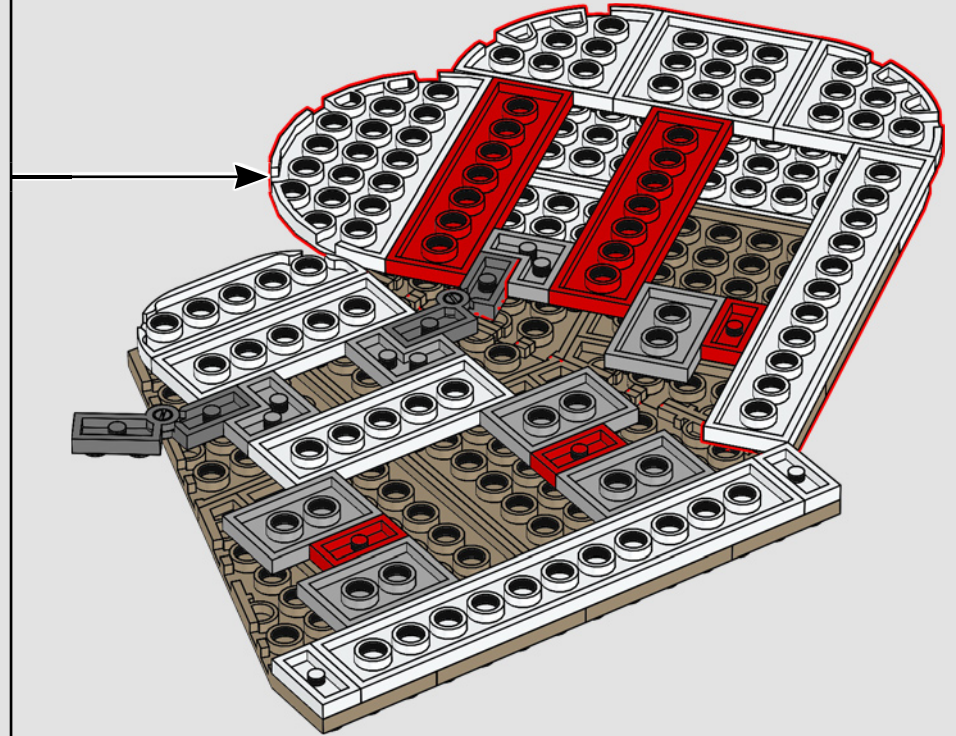

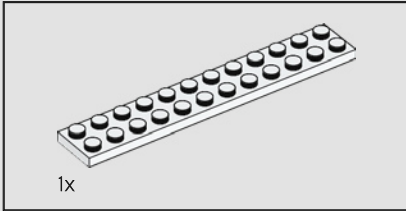
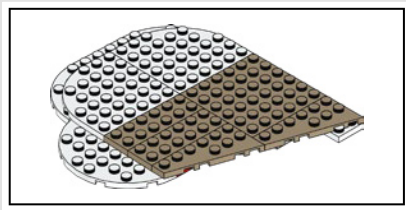

19

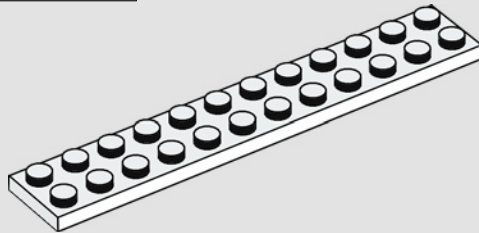

20

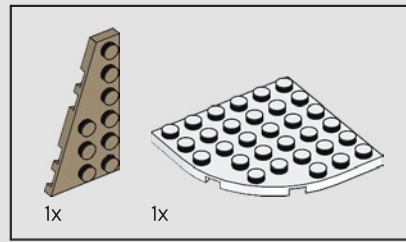
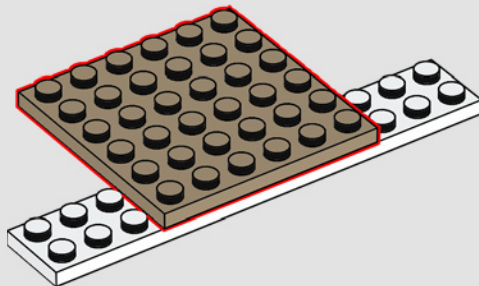

21

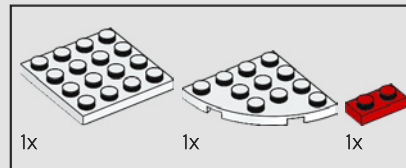
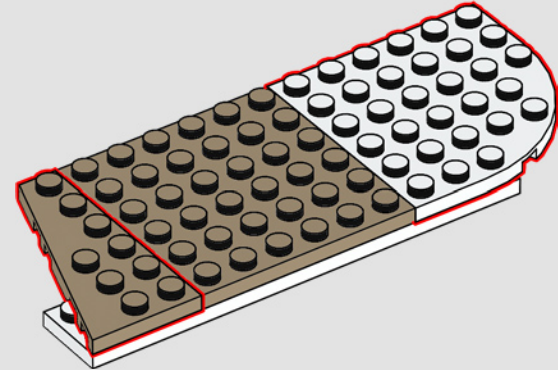

22

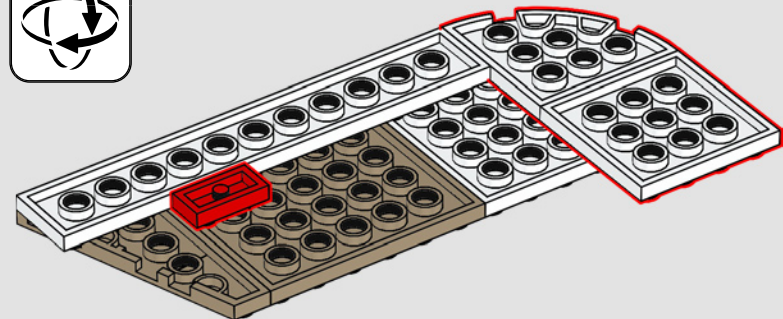
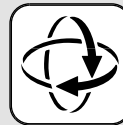

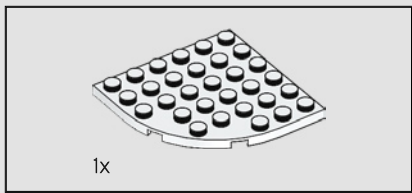

23

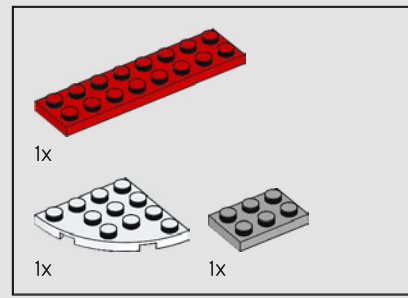

24

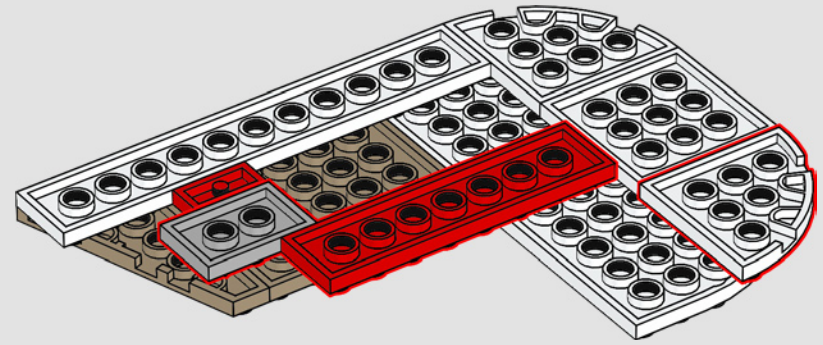
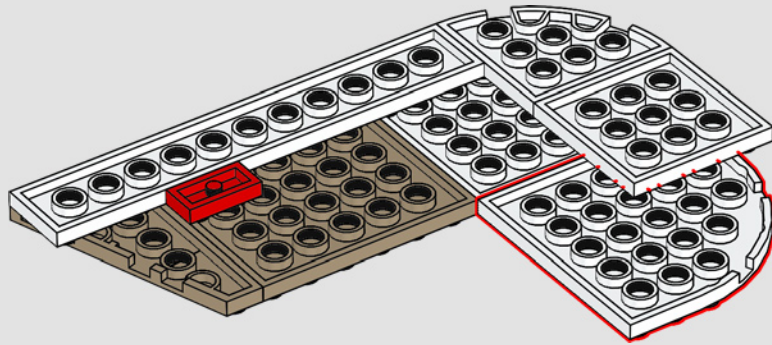

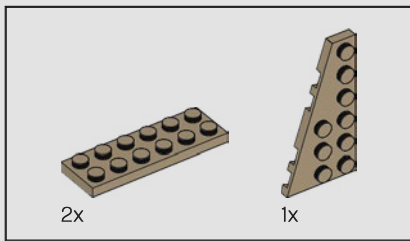

25

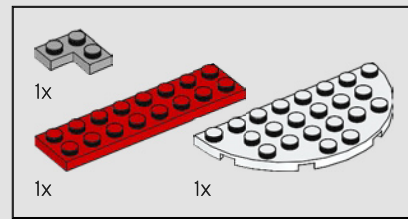
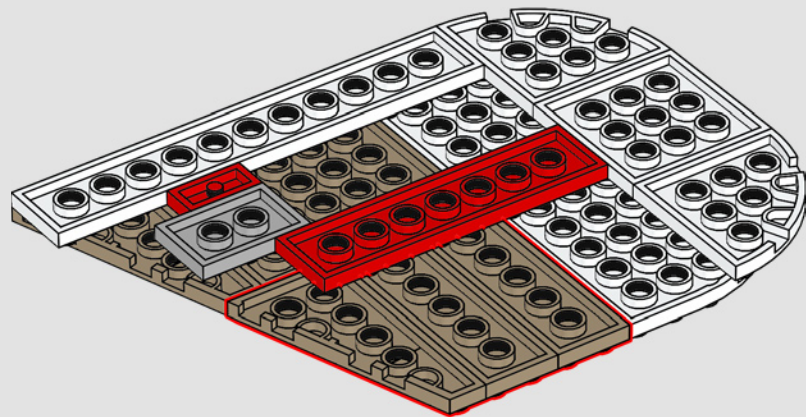

26

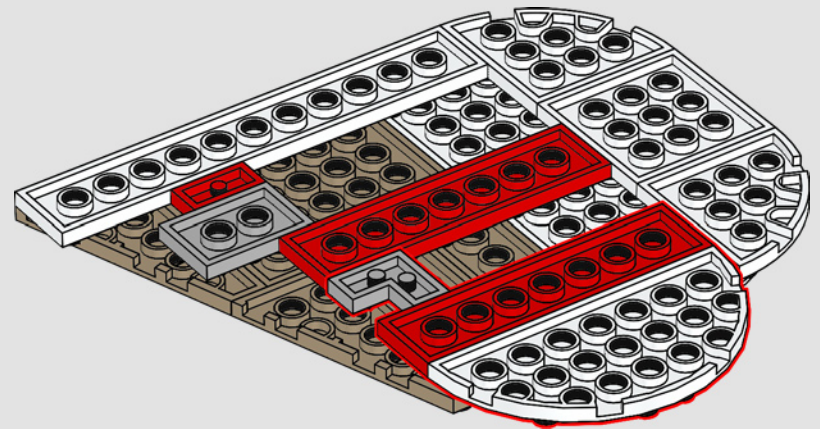

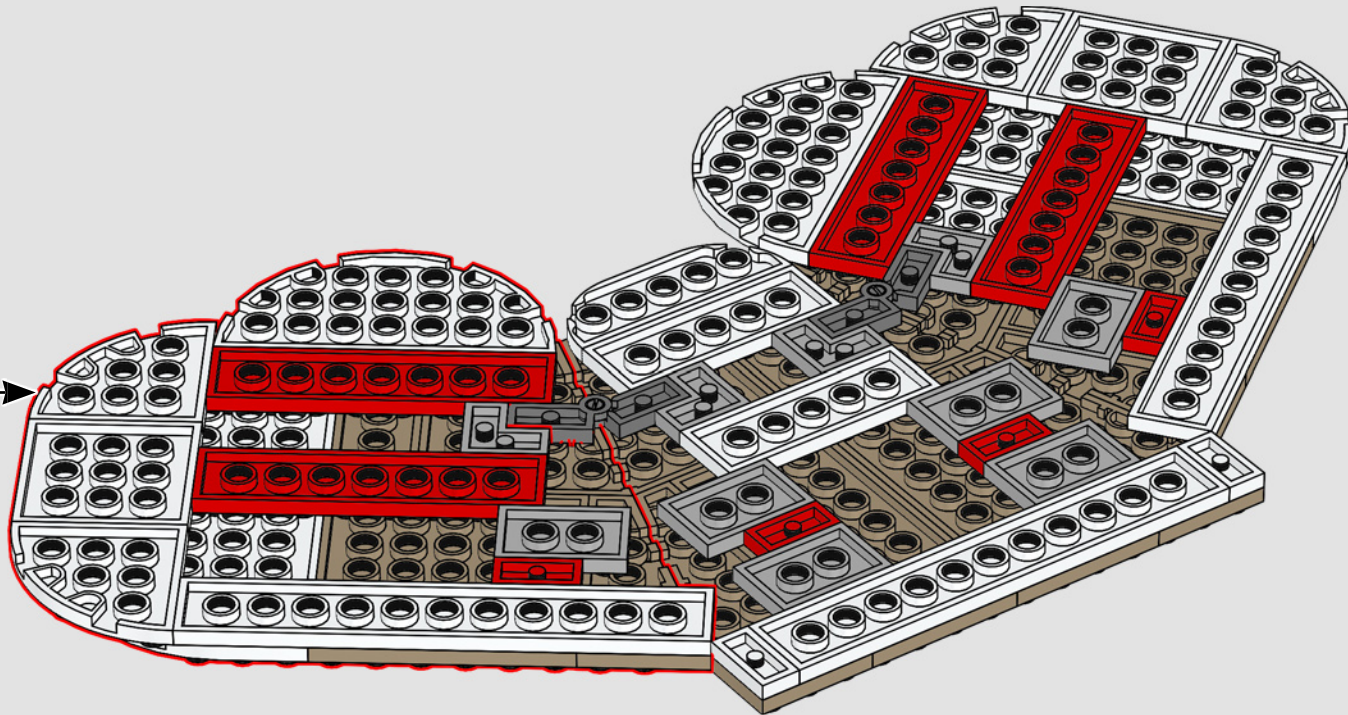

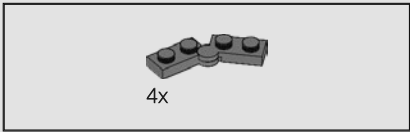

28

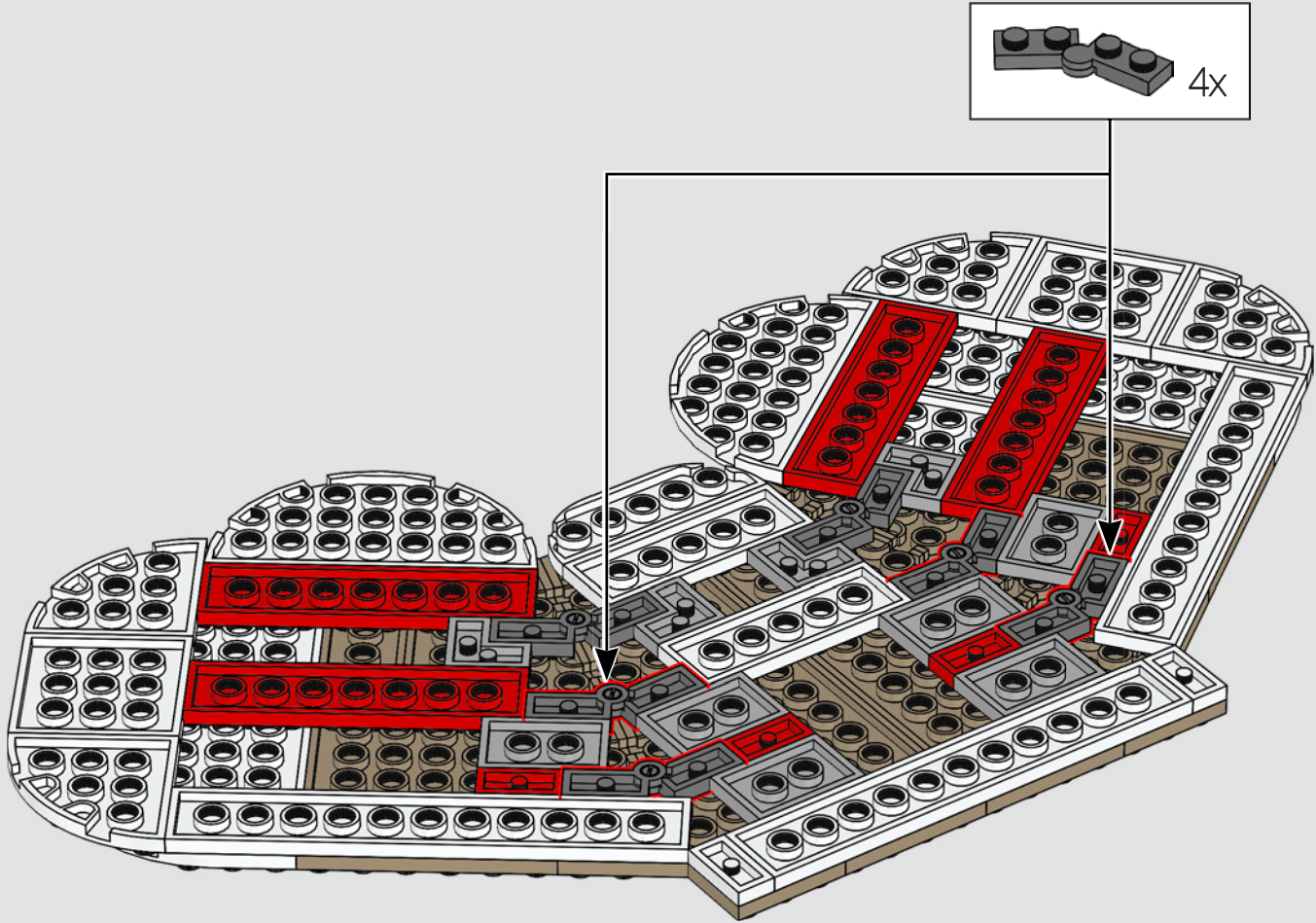

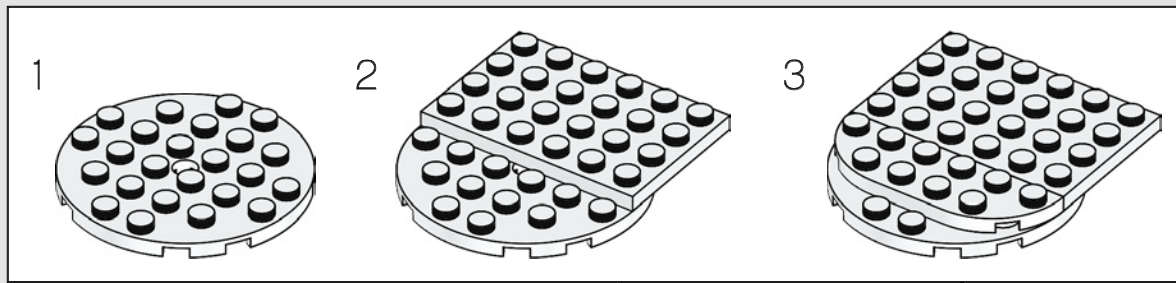
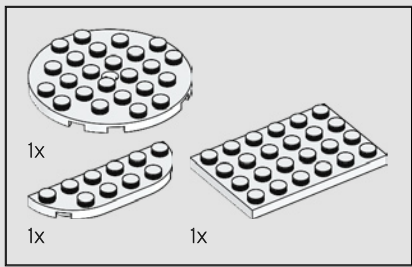

29

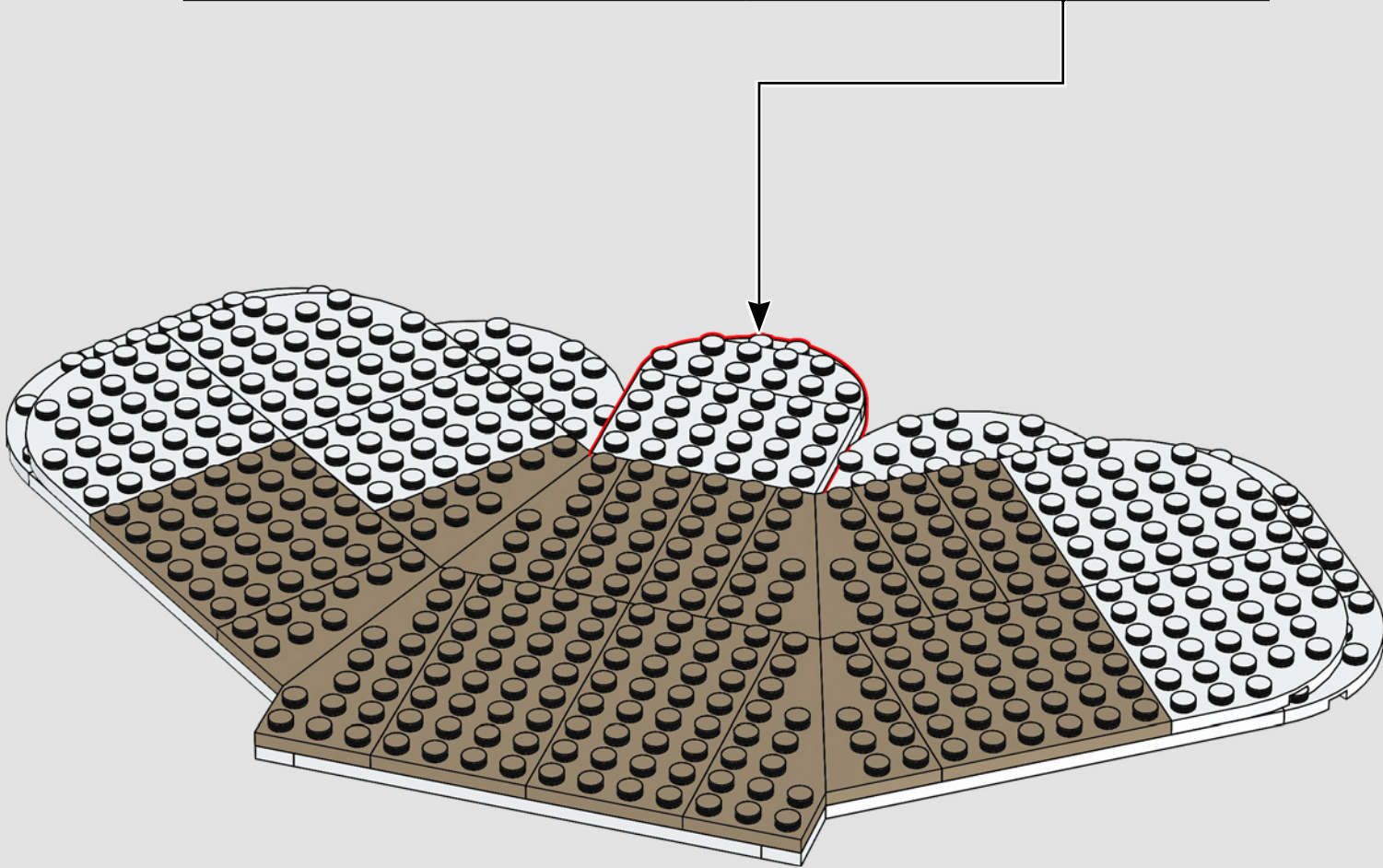

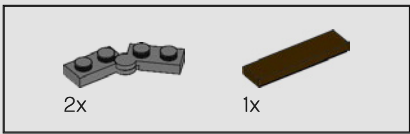

30

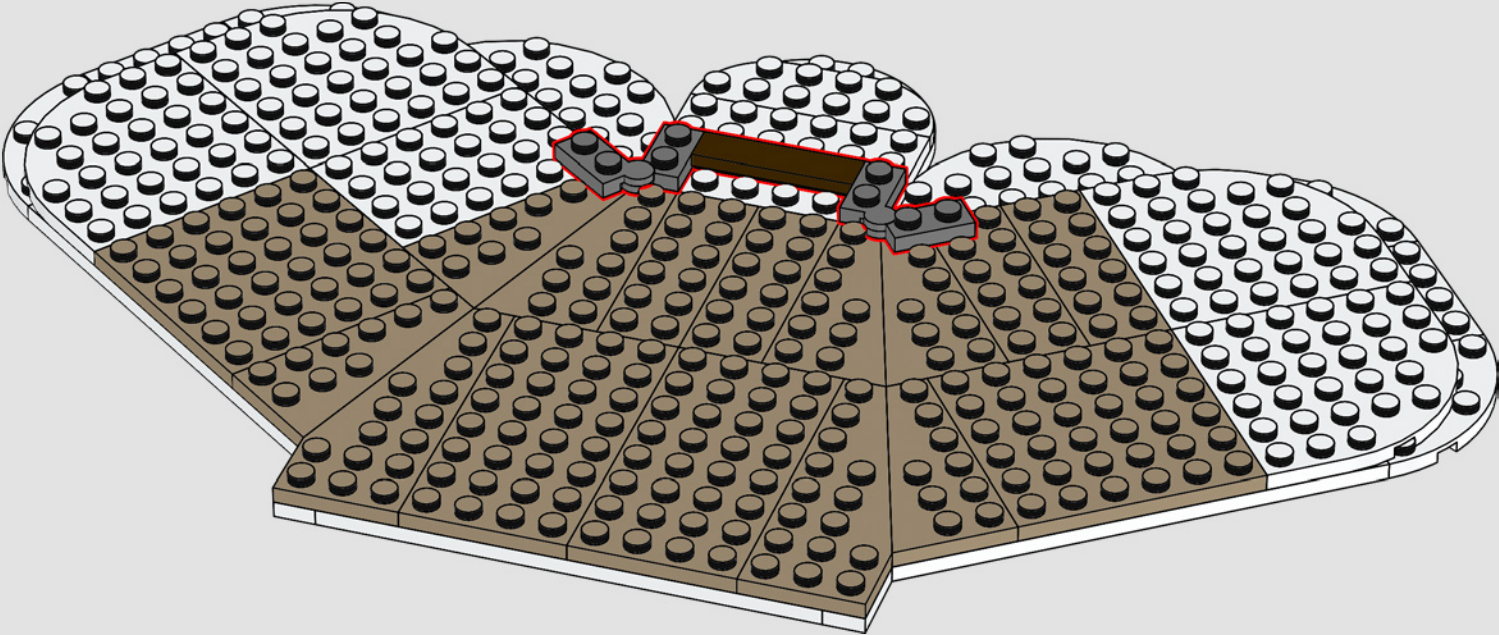

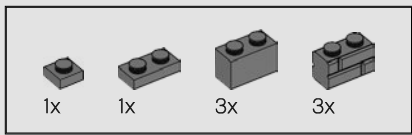

31

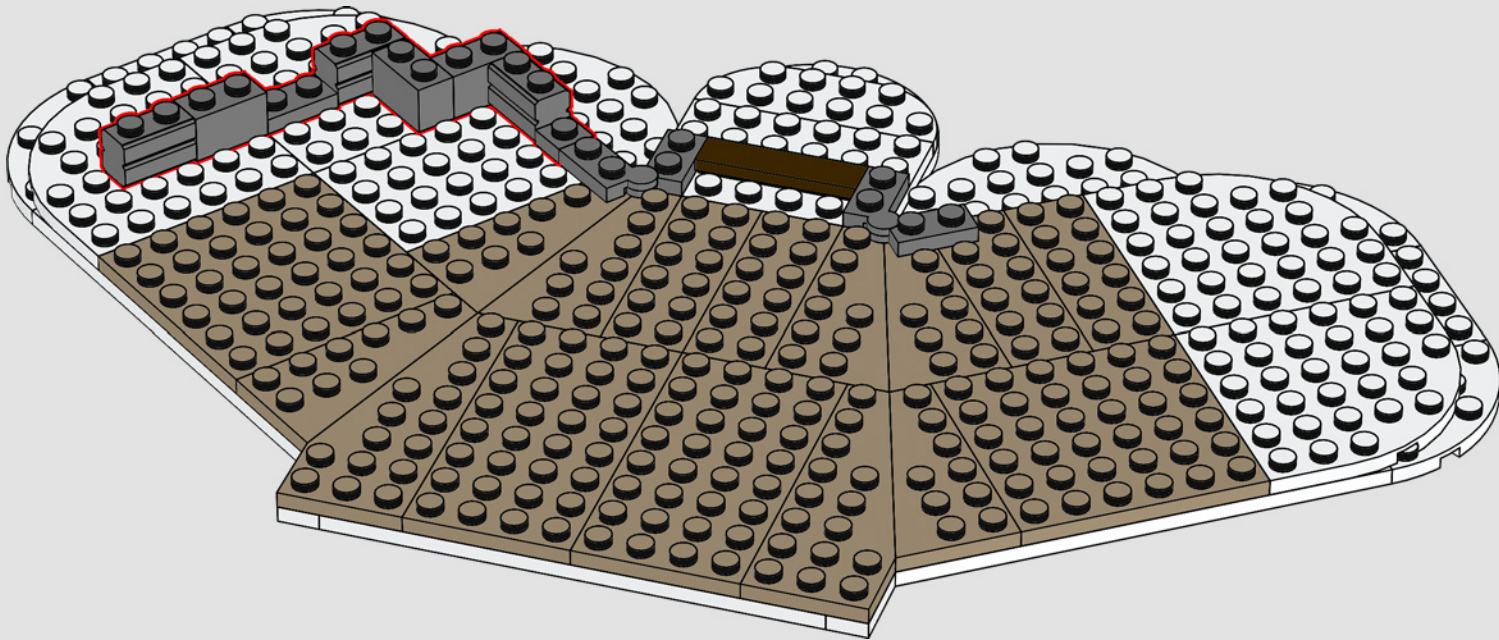

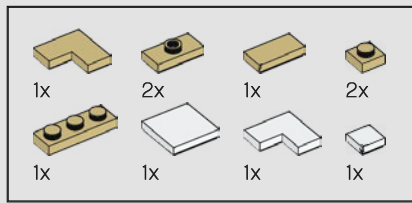

32

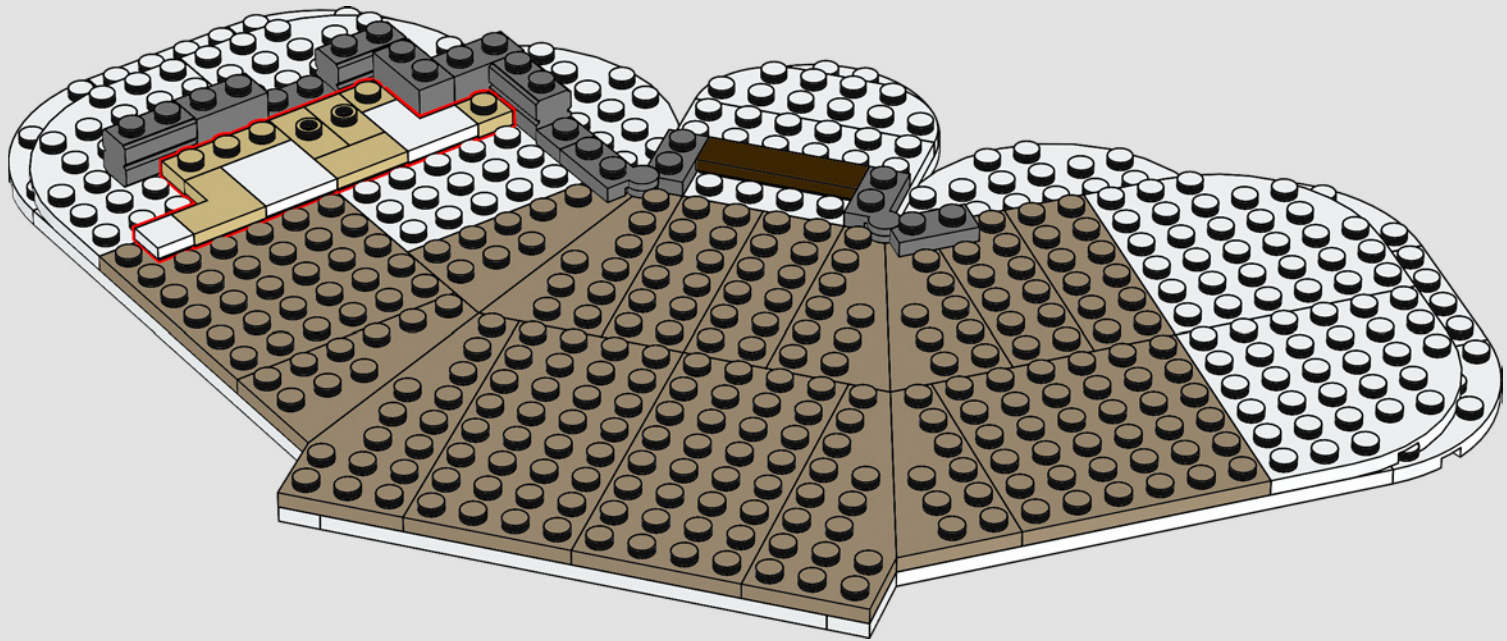

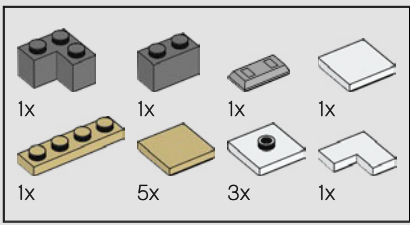

33

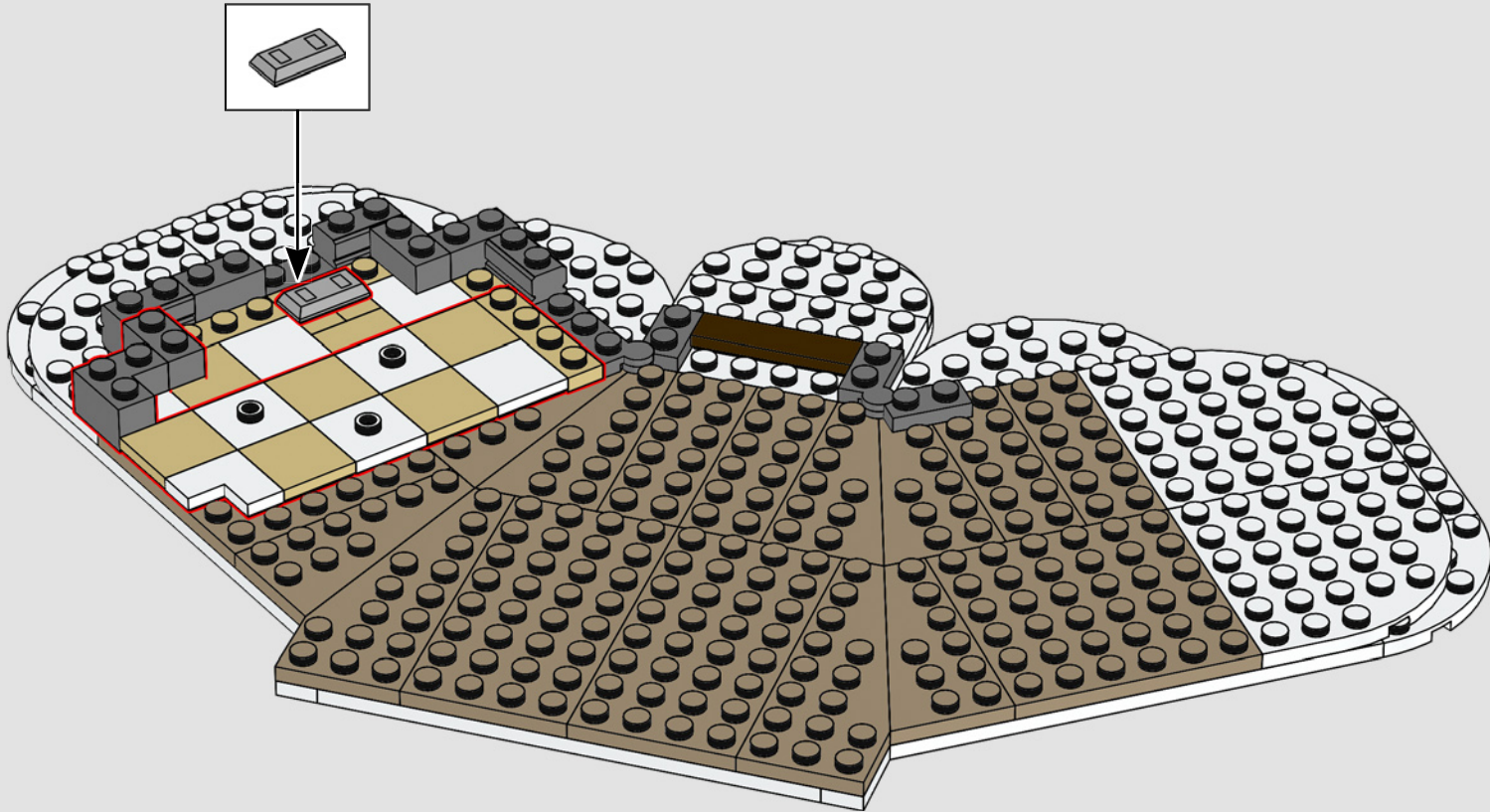

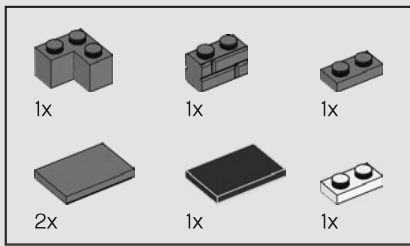

34

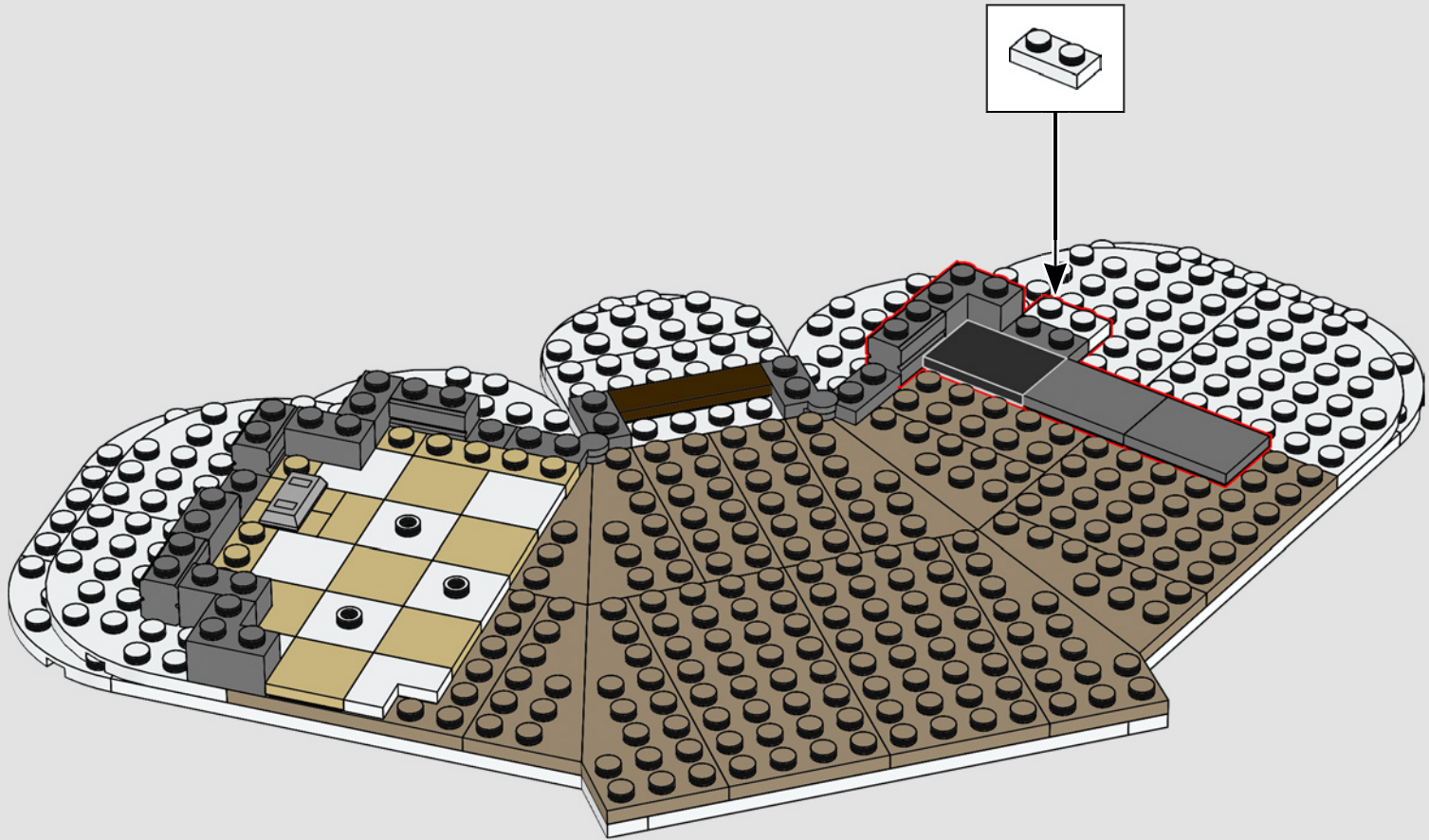

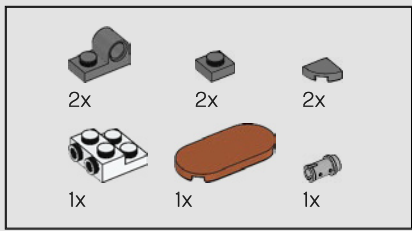

35

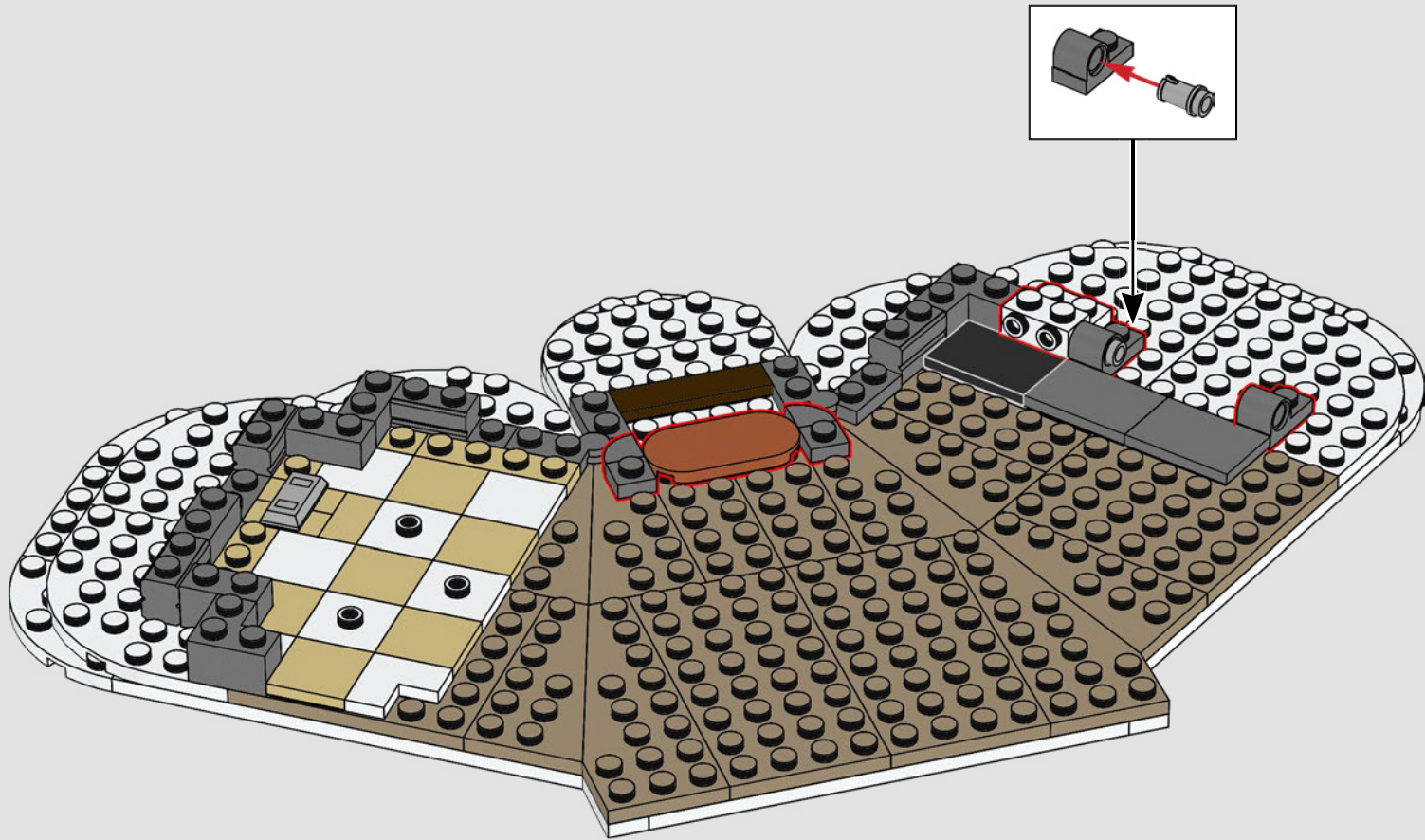

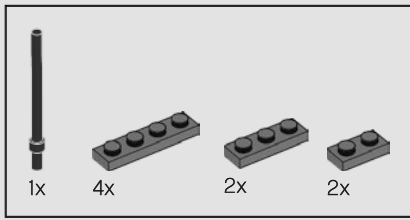

36

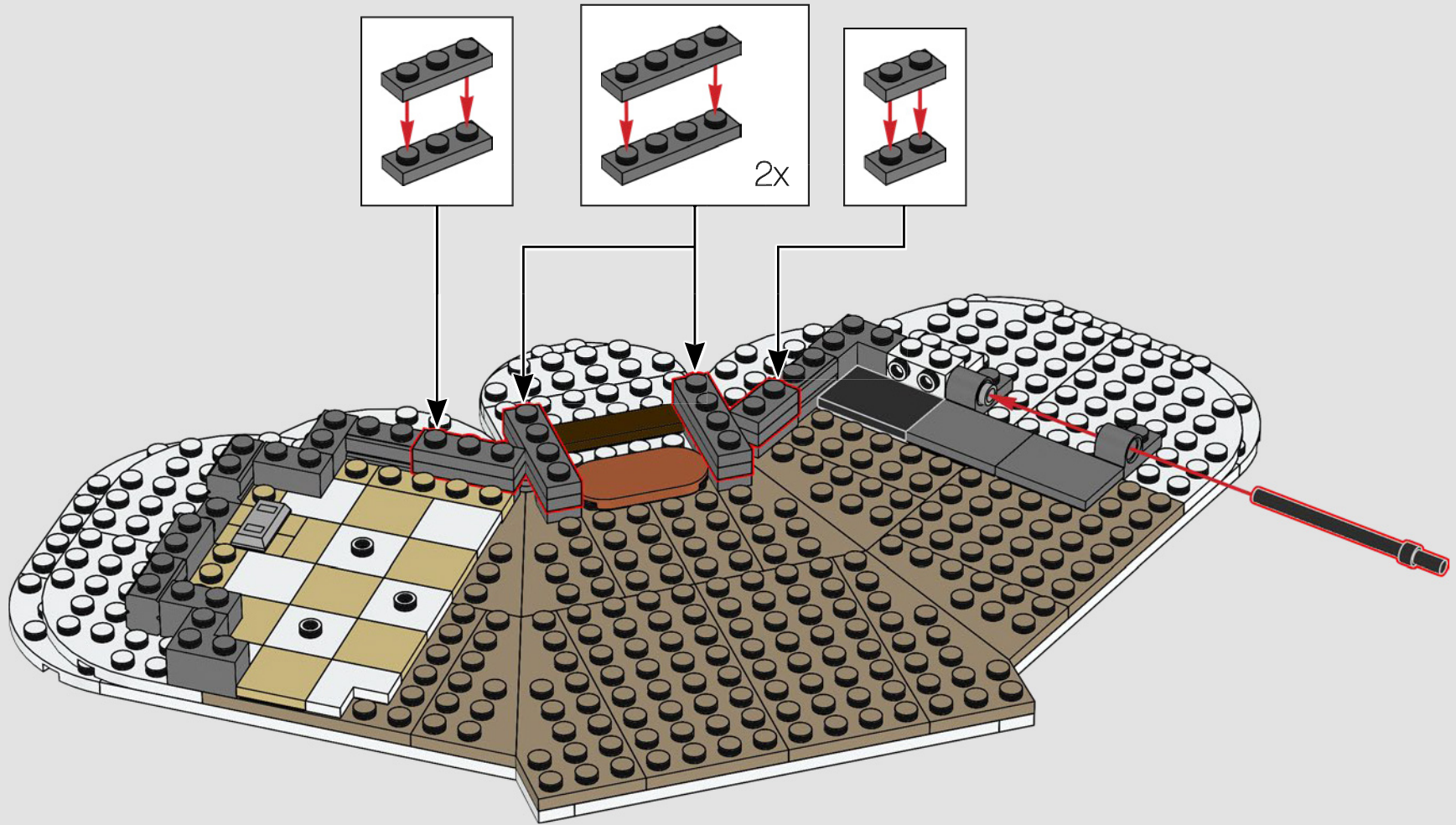

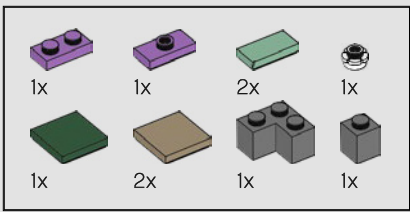

37

✦ ✦ ✦ ✦ ✦

I regali nascosti in giro per la casa sono un riferimento a quei poveri genitori che devono trovare sempre un posto nuovo per nascondere i regali dei bambini!

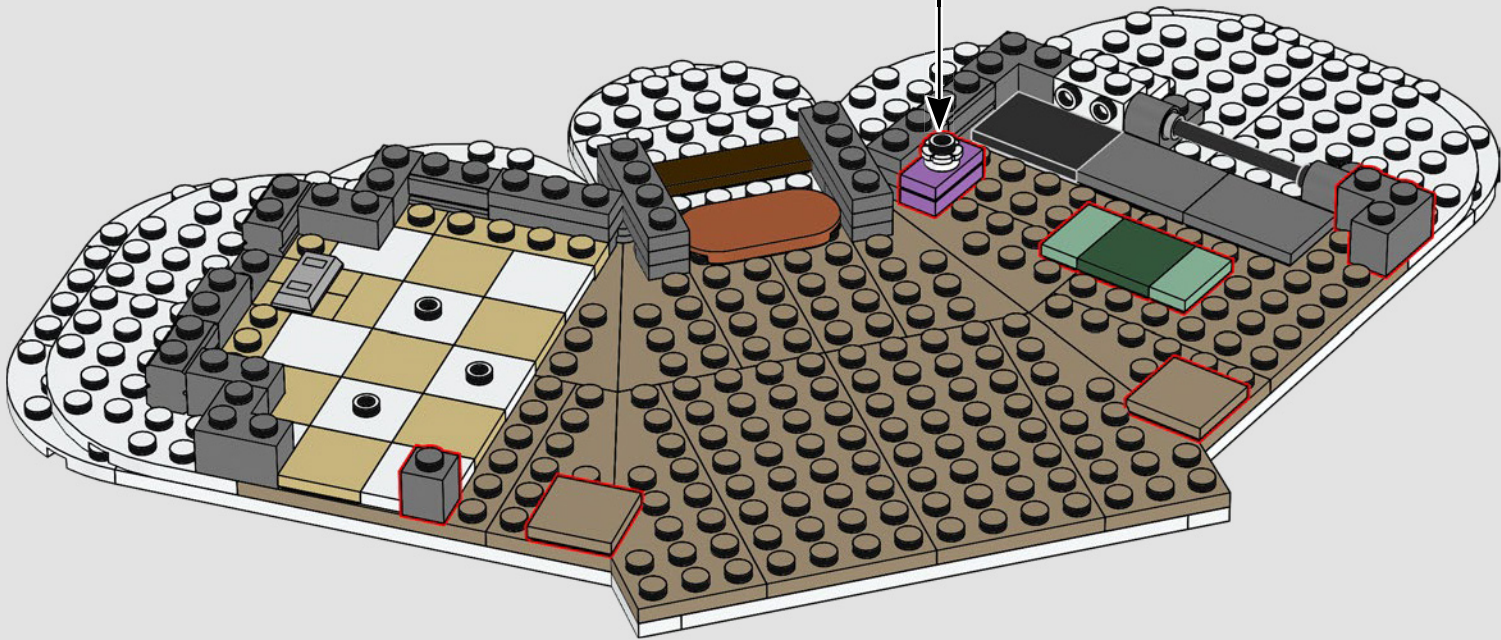
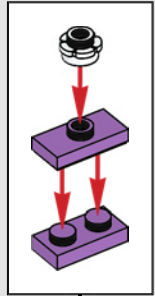

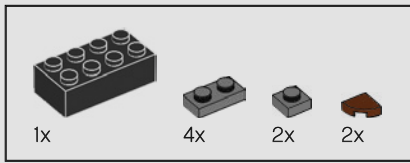

38

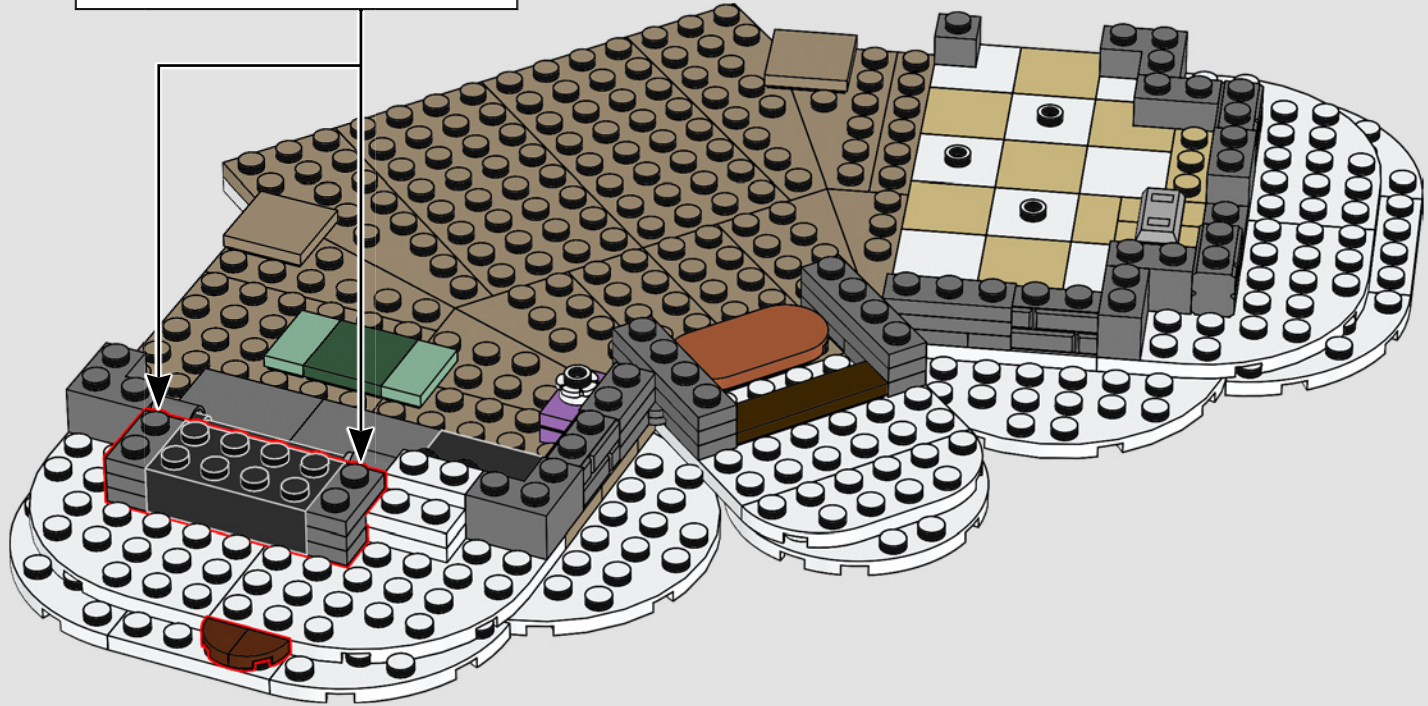
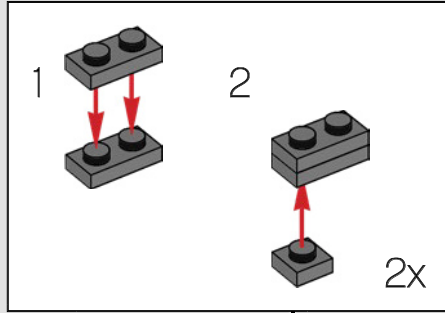

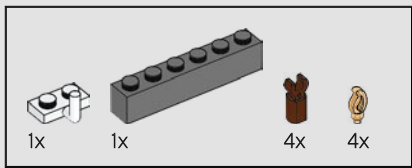

39

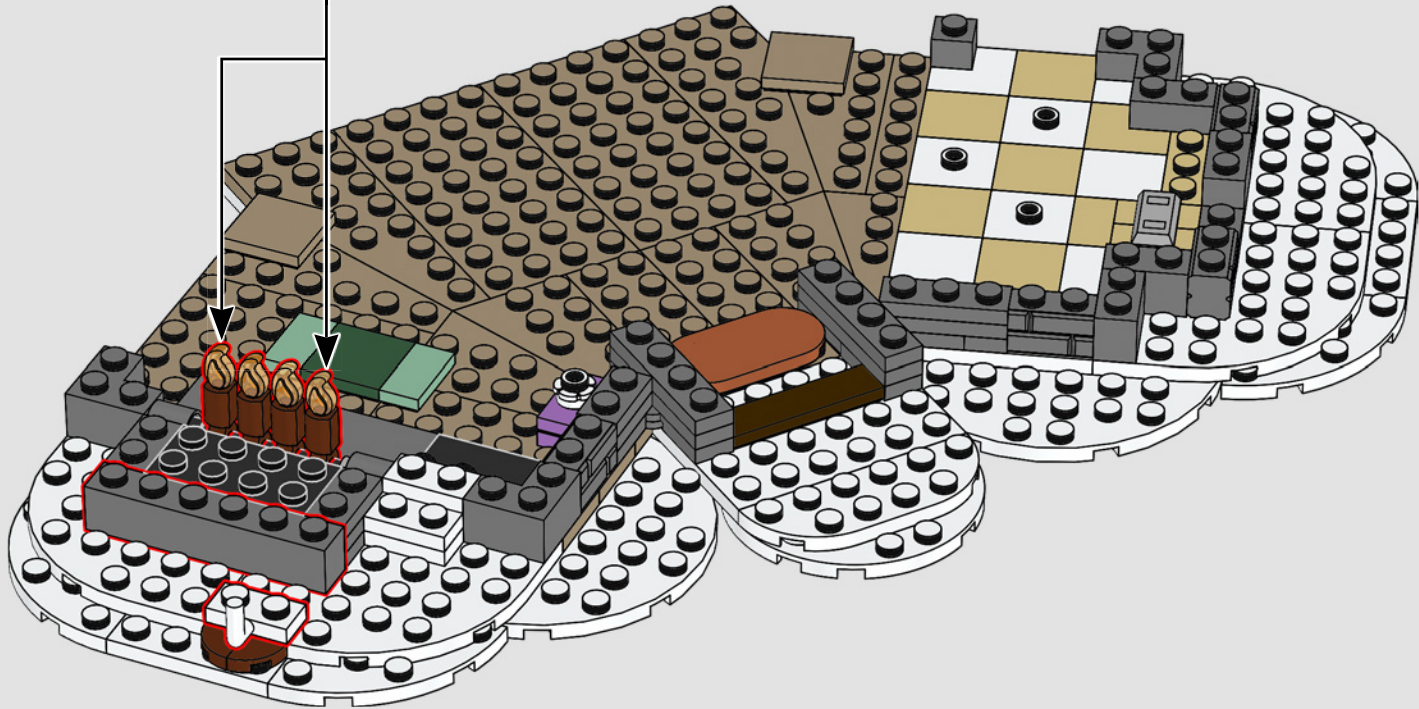
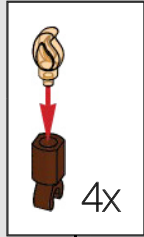

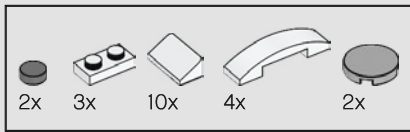

40

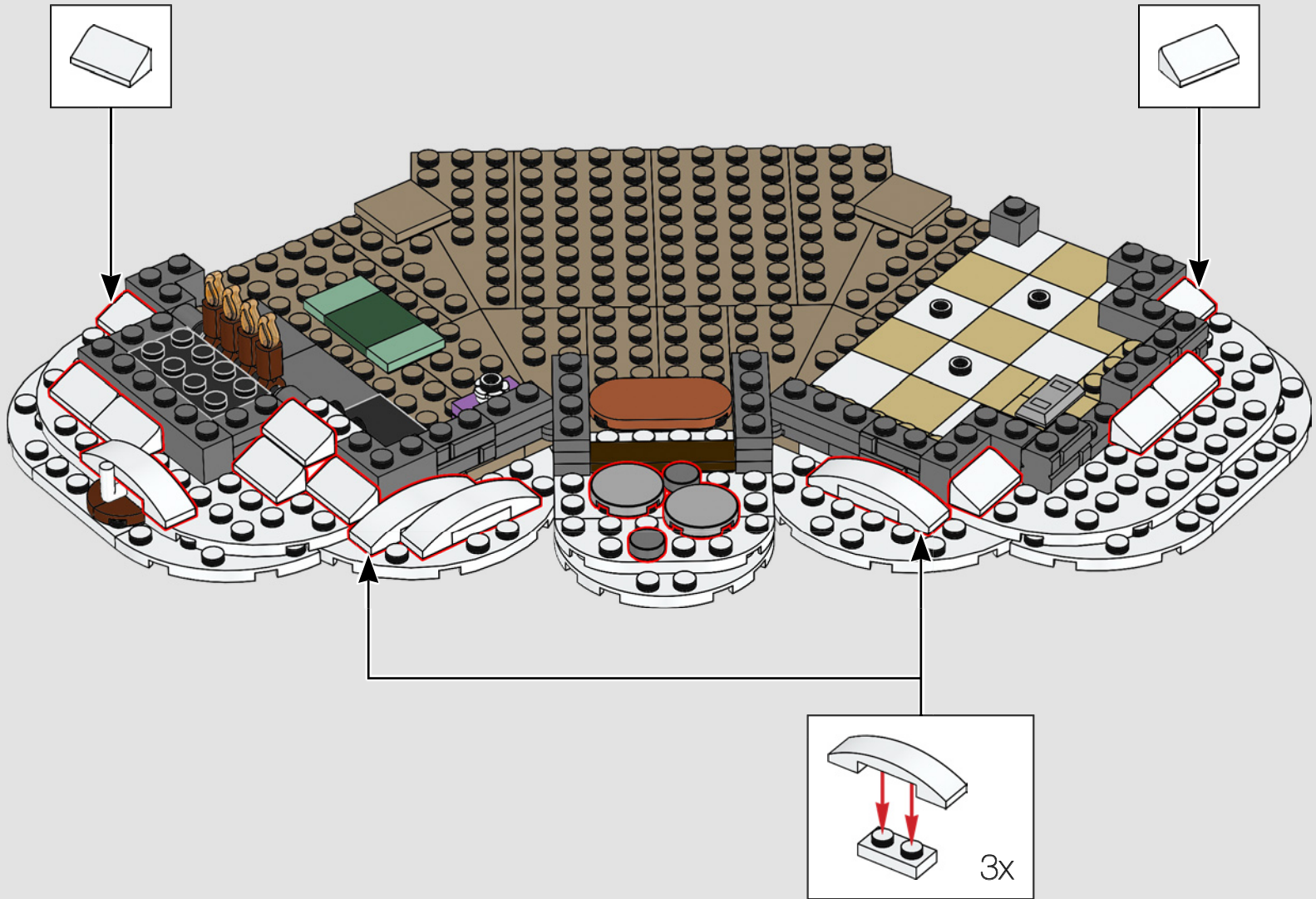

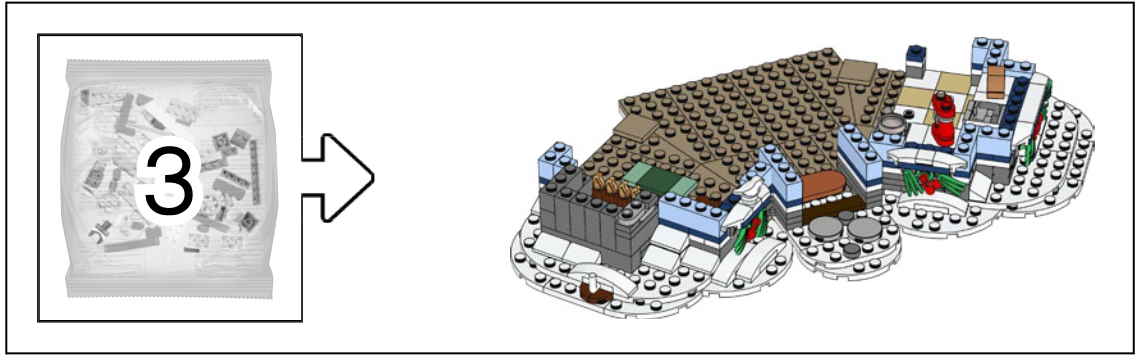

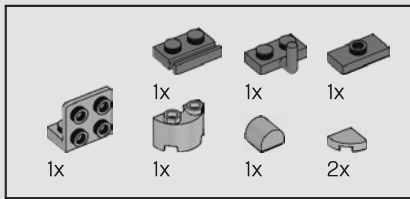

41

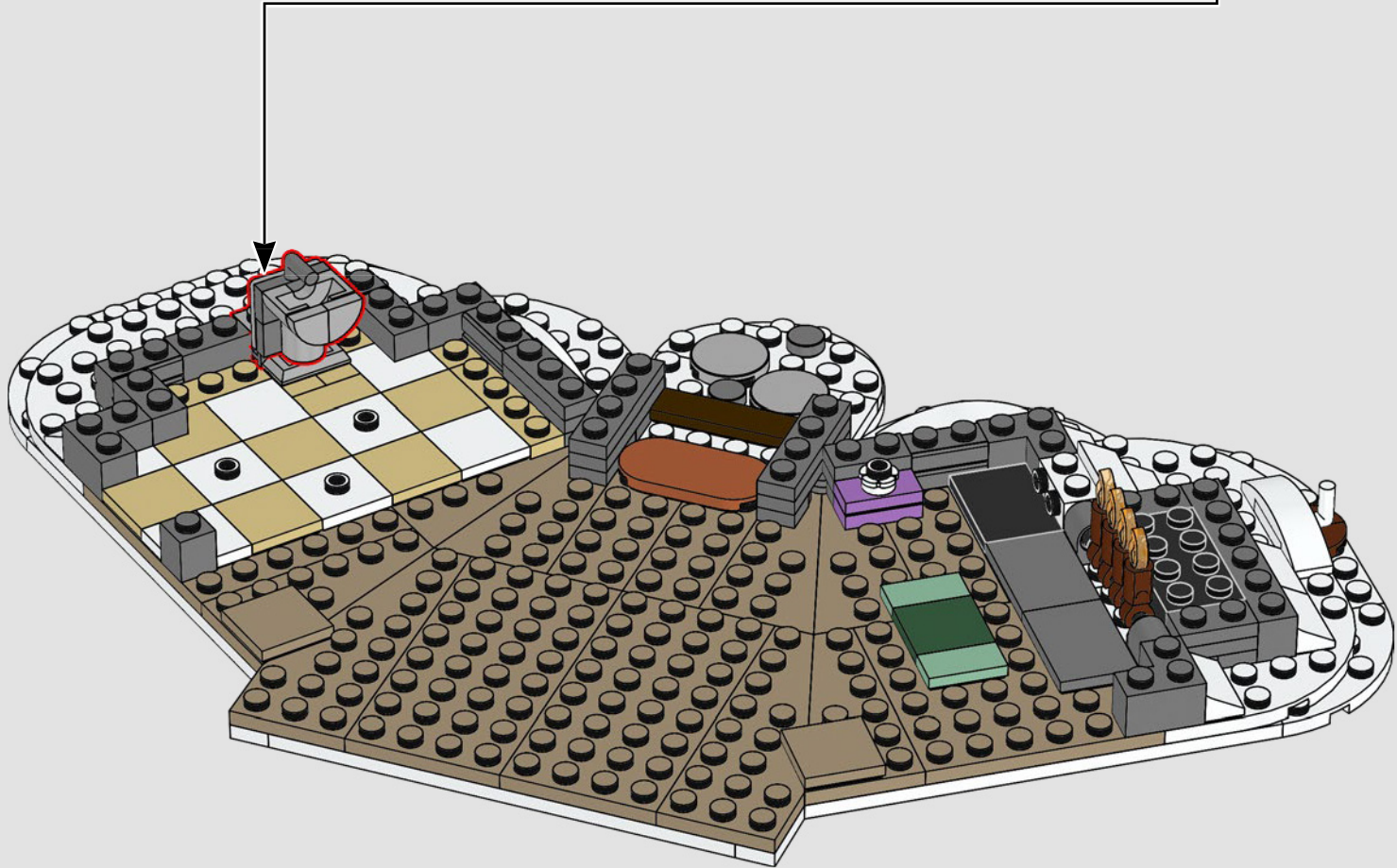
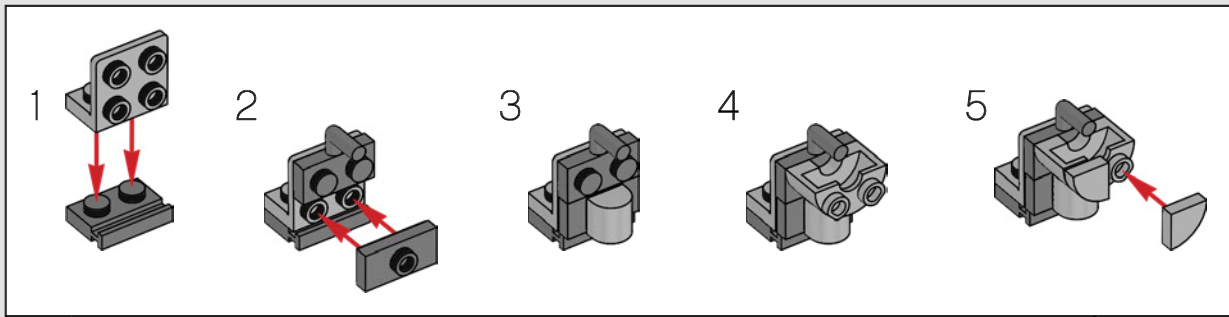

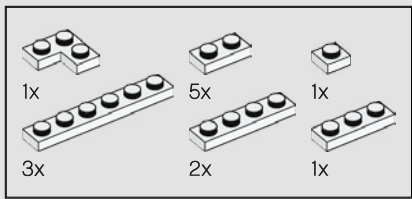

42

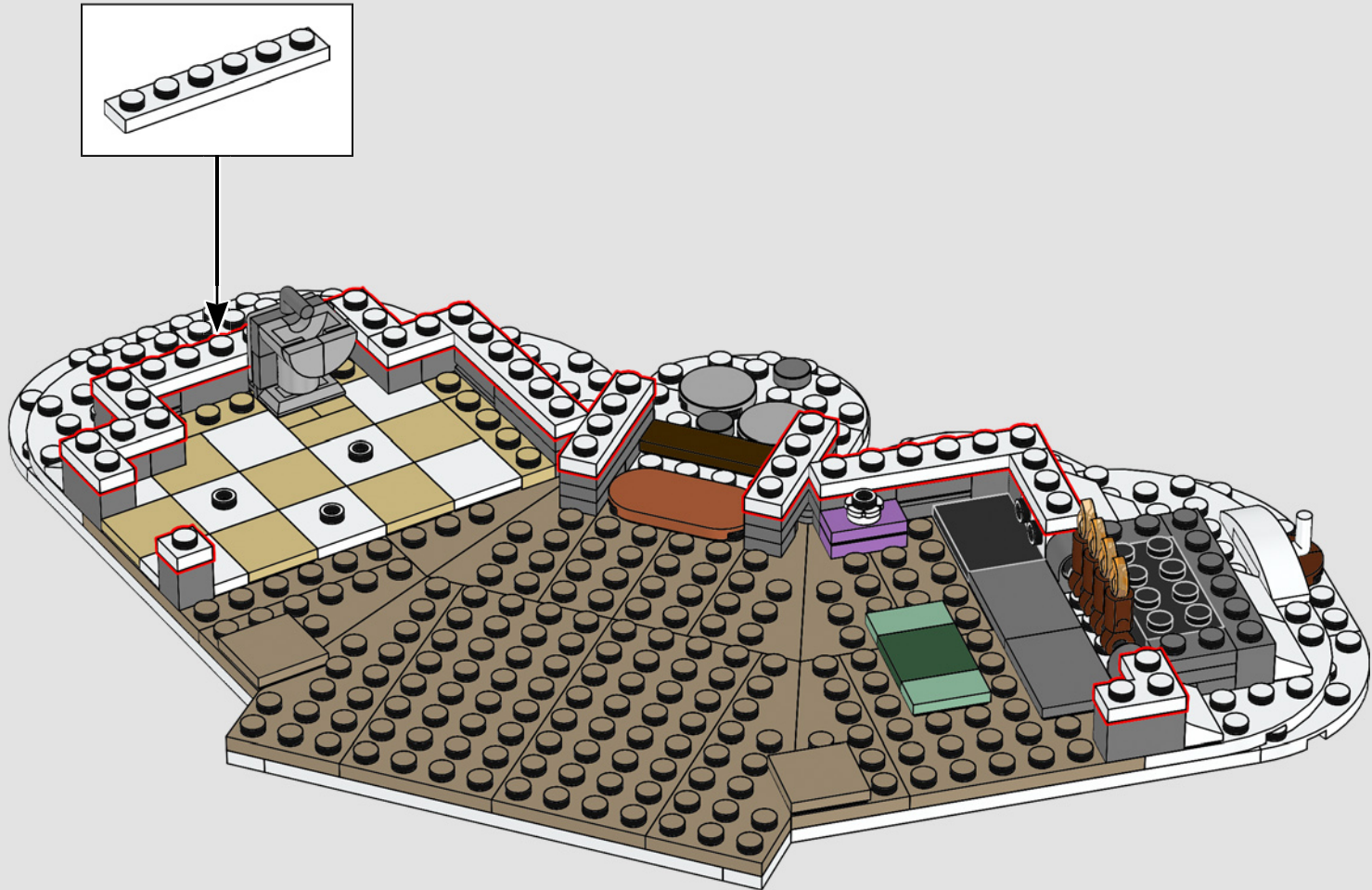

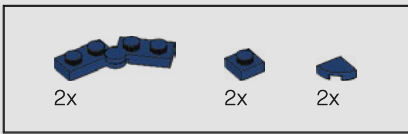

43



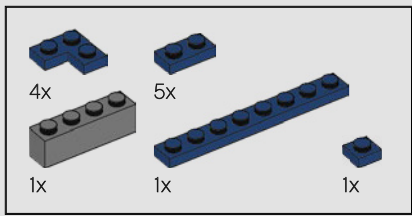

44

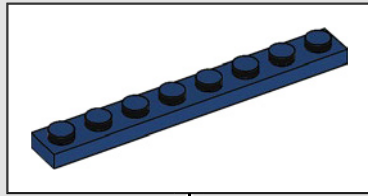

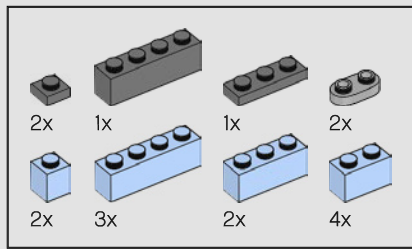

45

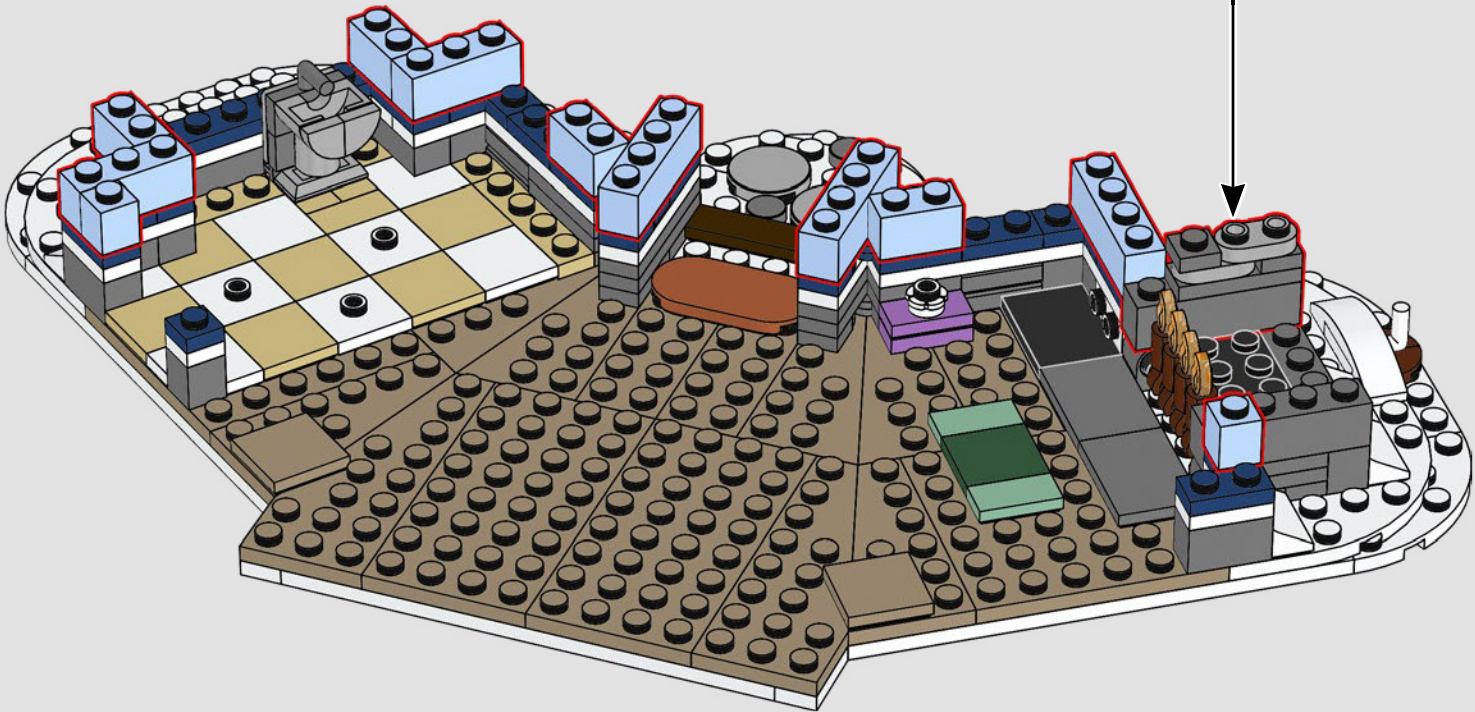
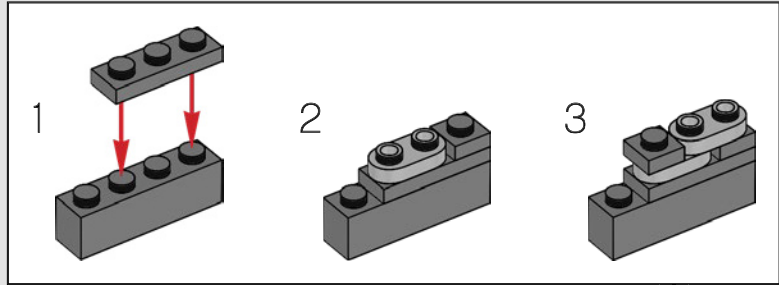

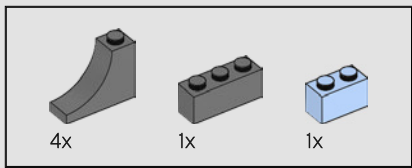

46

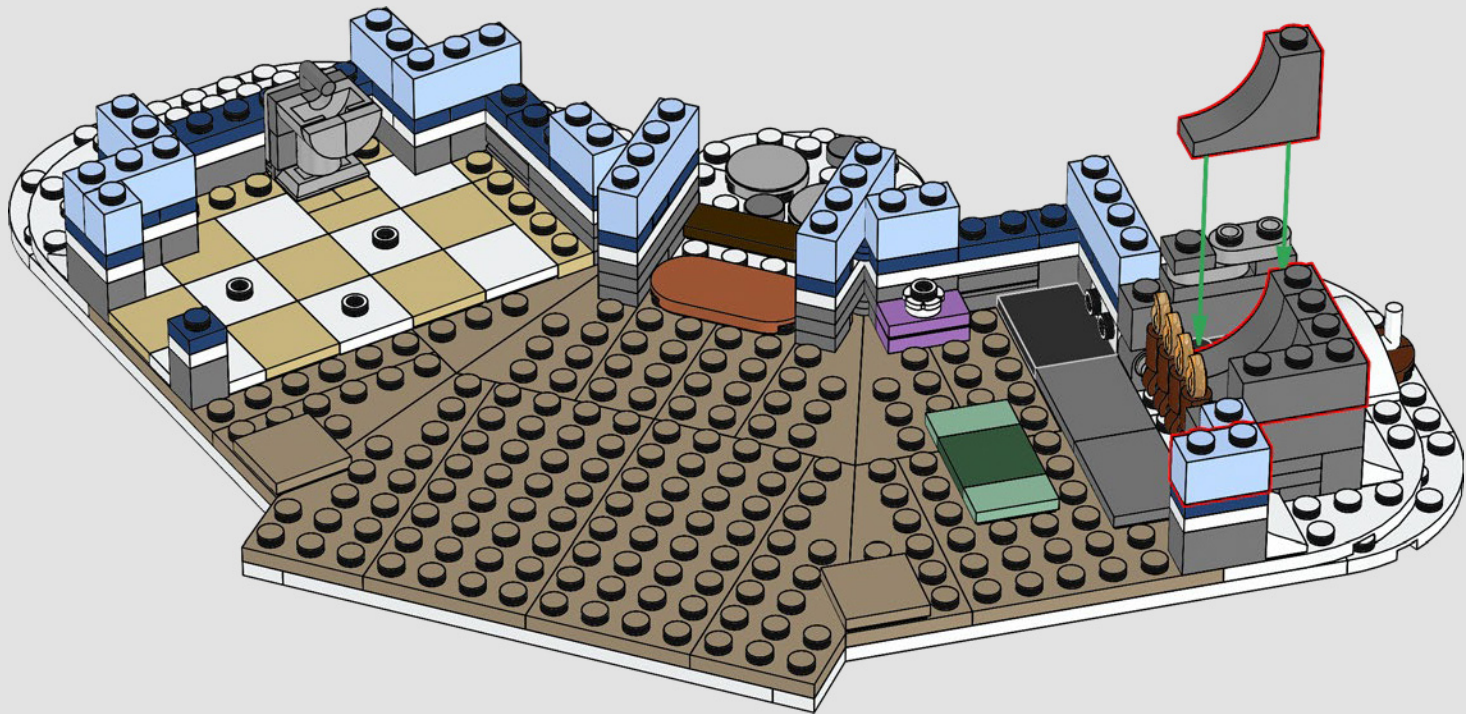

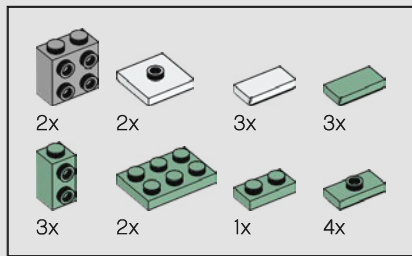

47

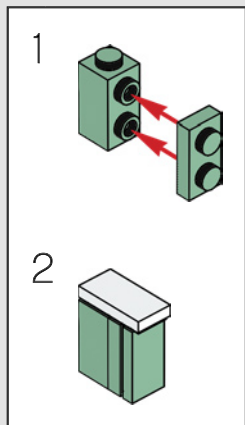
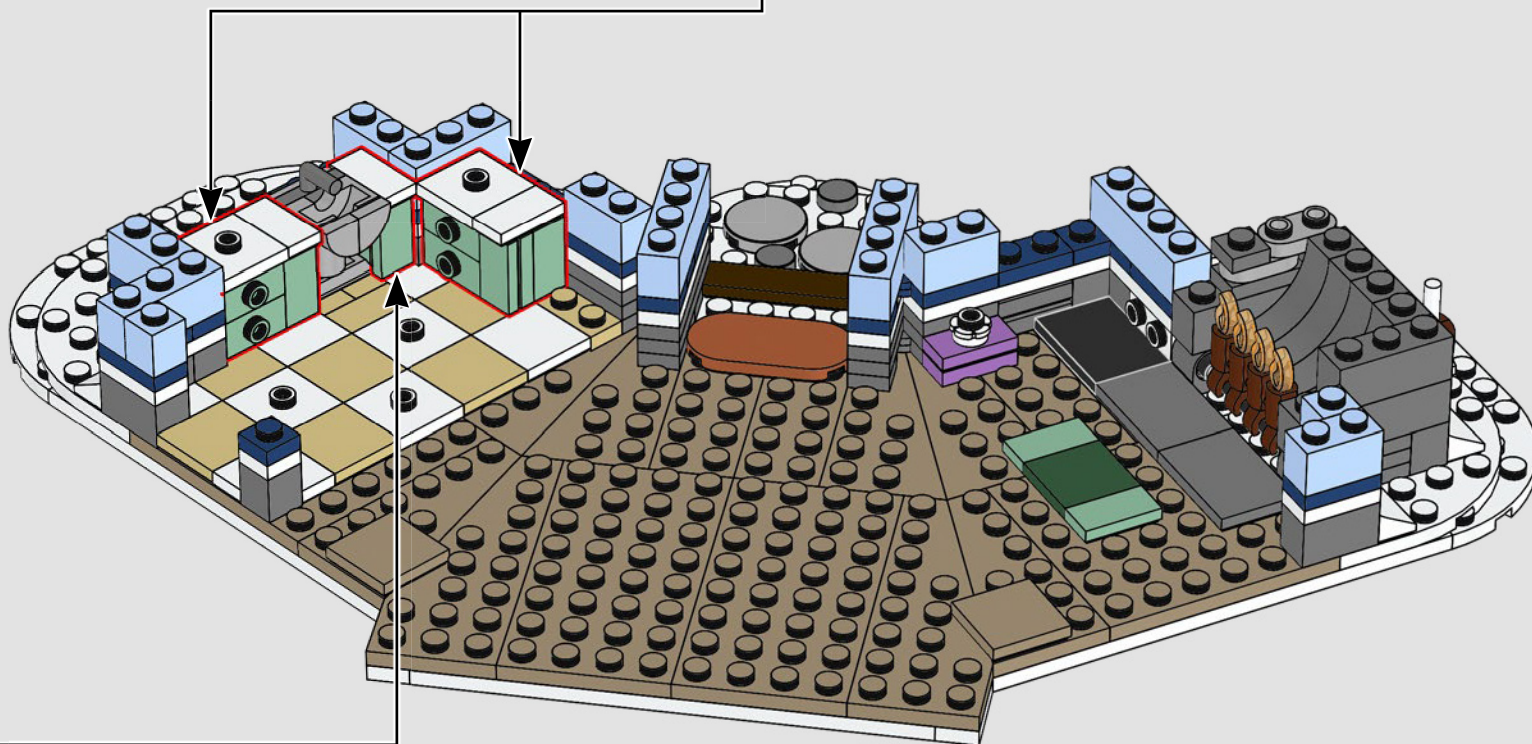
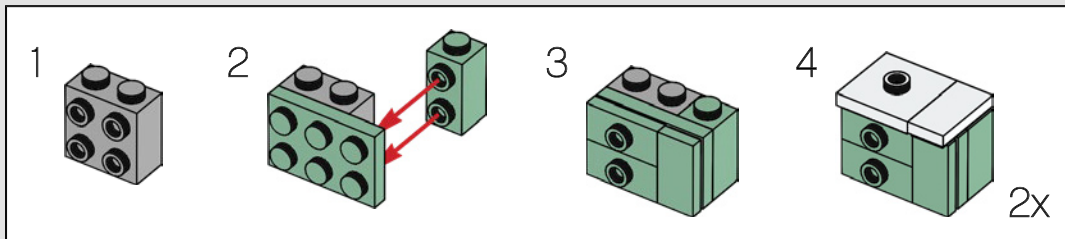

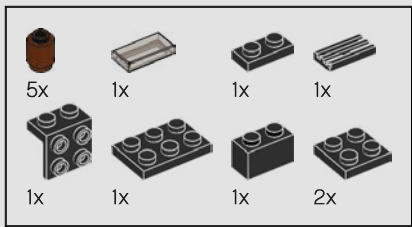

48

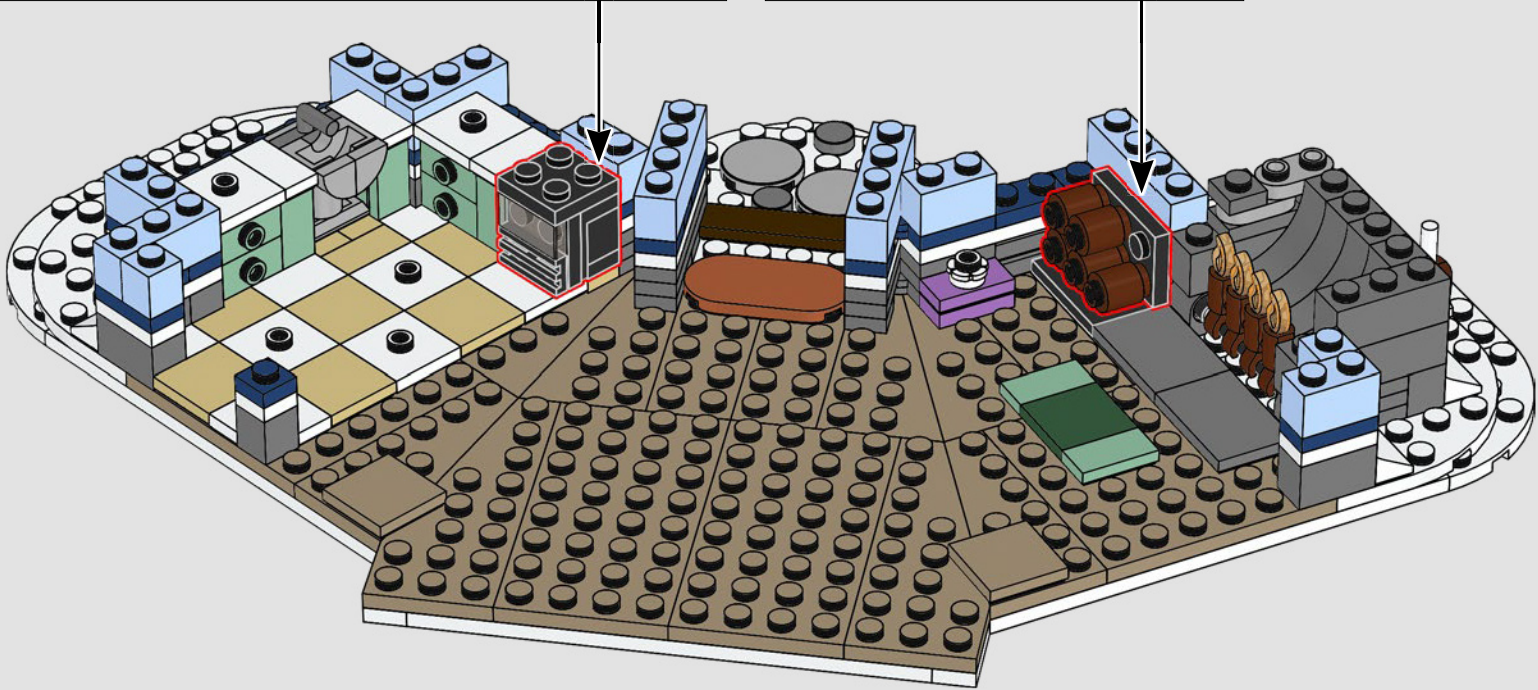
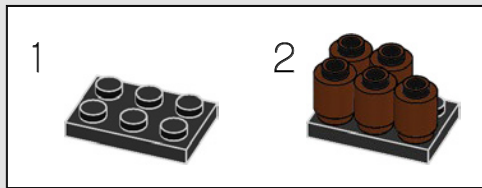
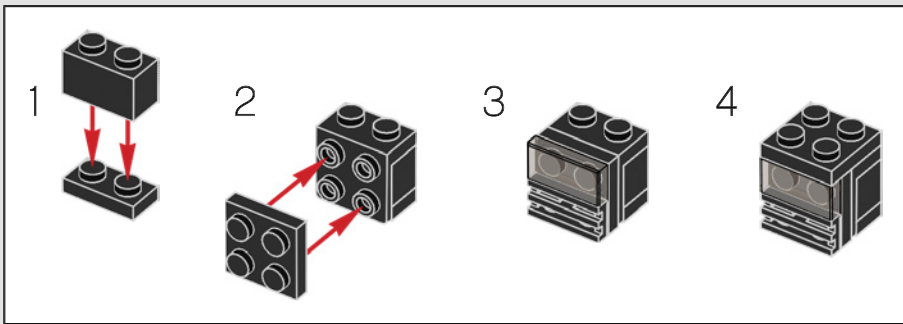

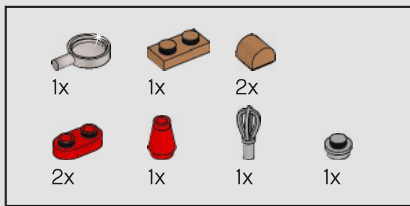

49

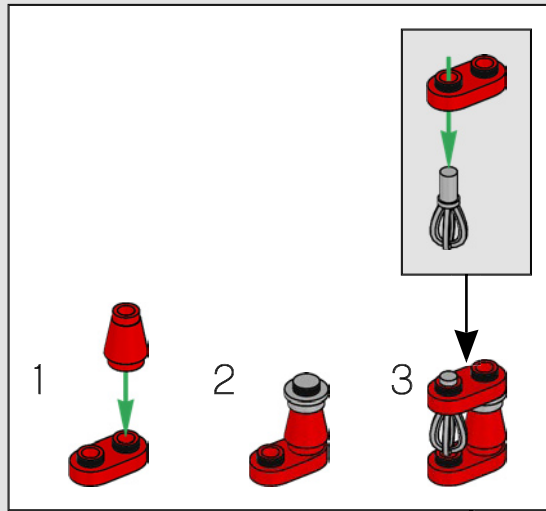
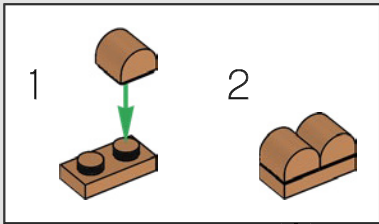

La parte 49307 è talvolta chiamata ufficiosamente "pagnotta" dai designer LEGO®. Qui viene effettivamente utilizzata per creare una pagnotta di pane.

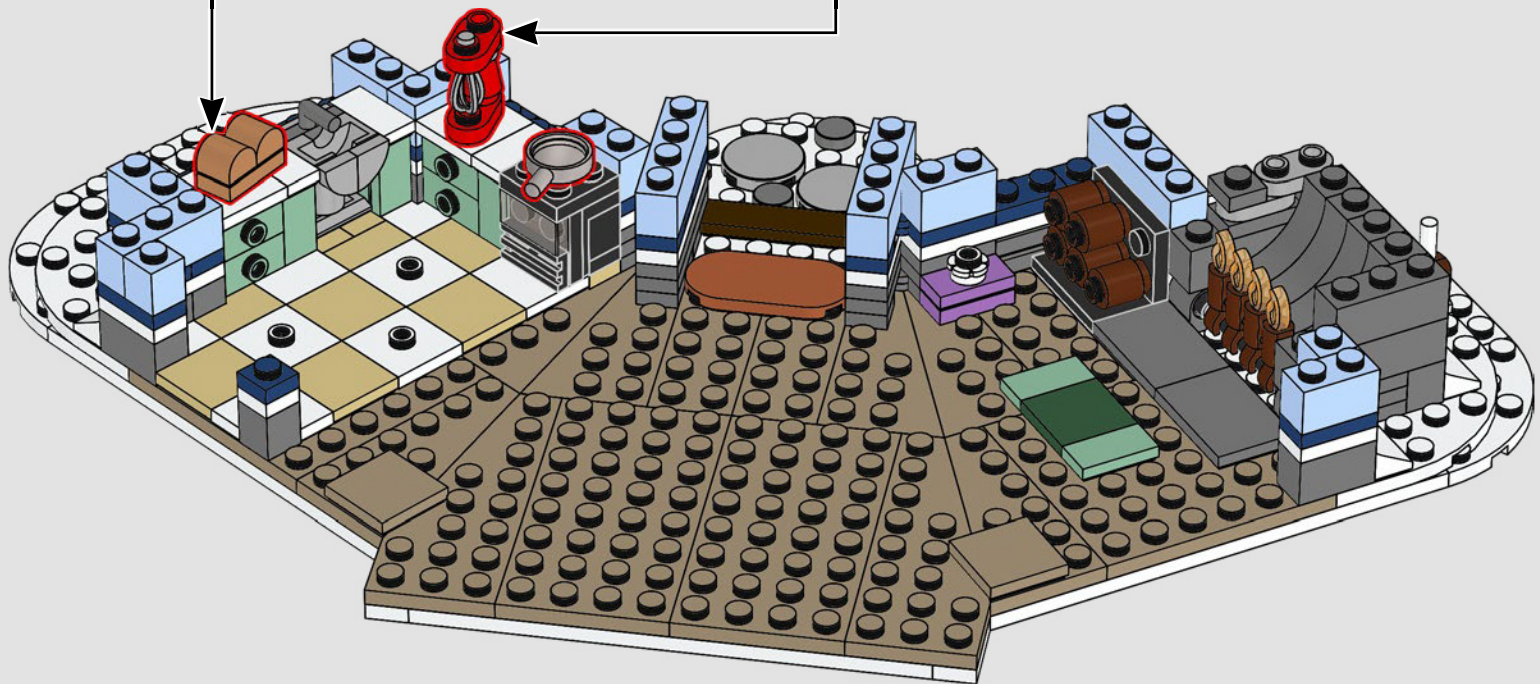

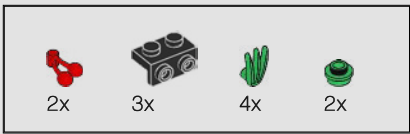

50

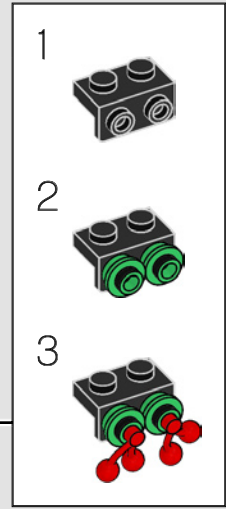
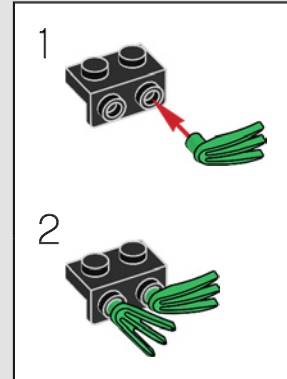
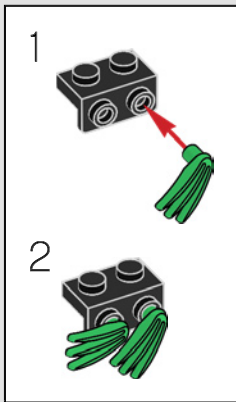

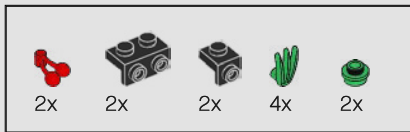

51

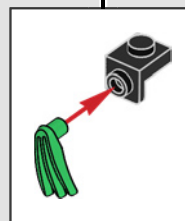
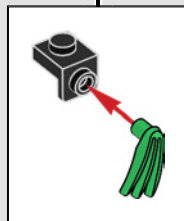
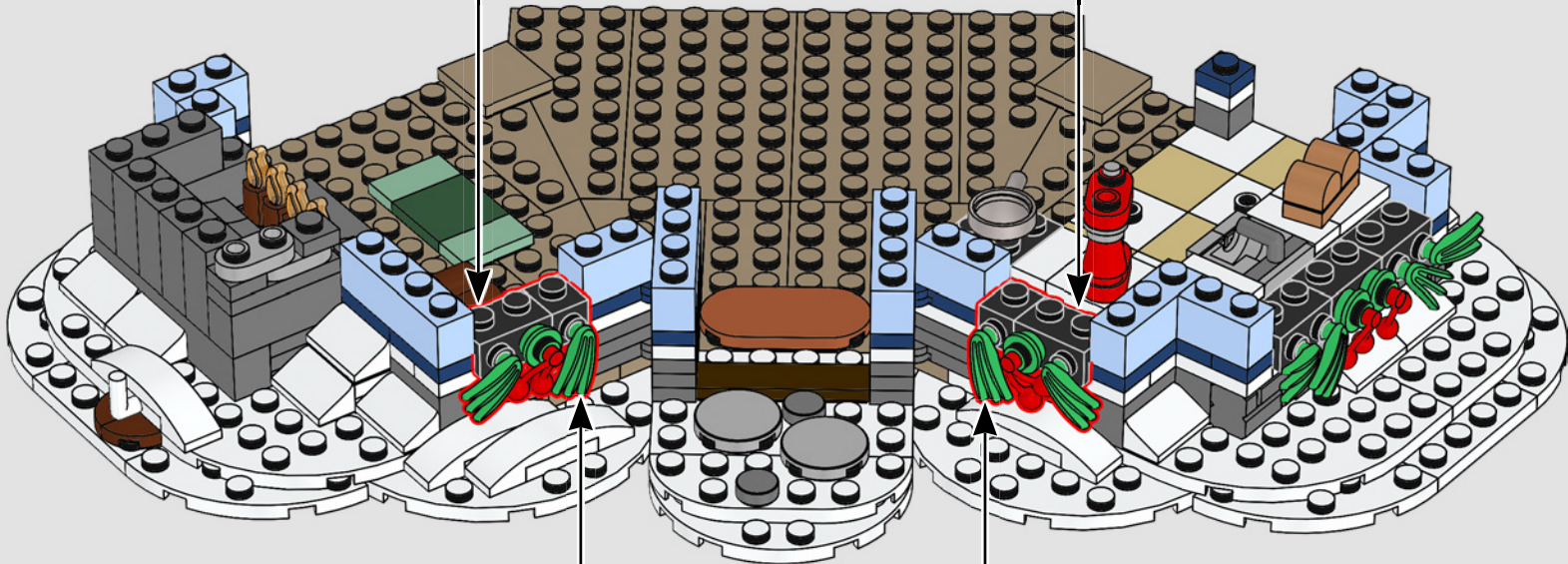
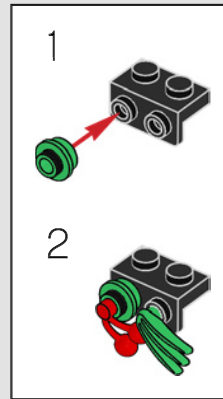
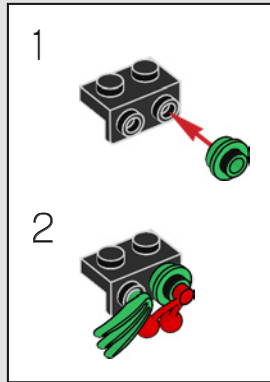

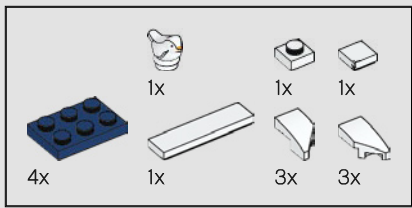

52

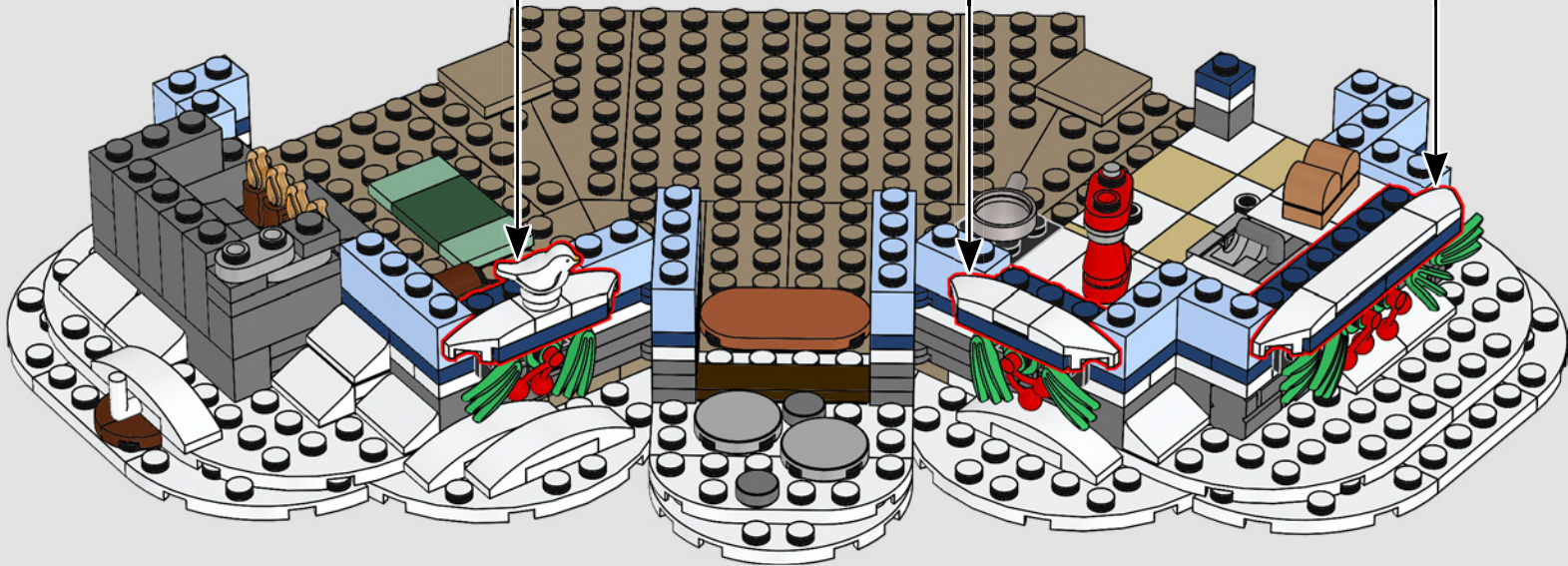
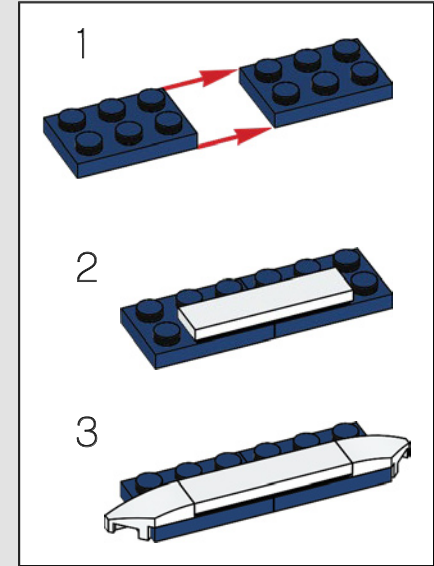
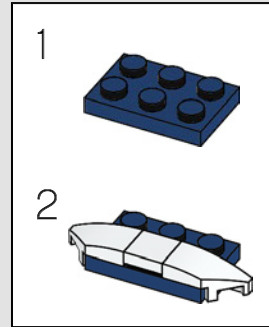
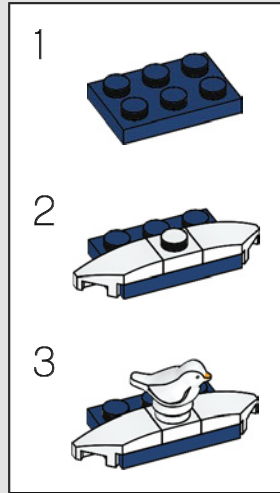

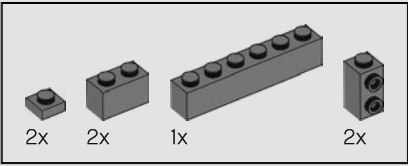
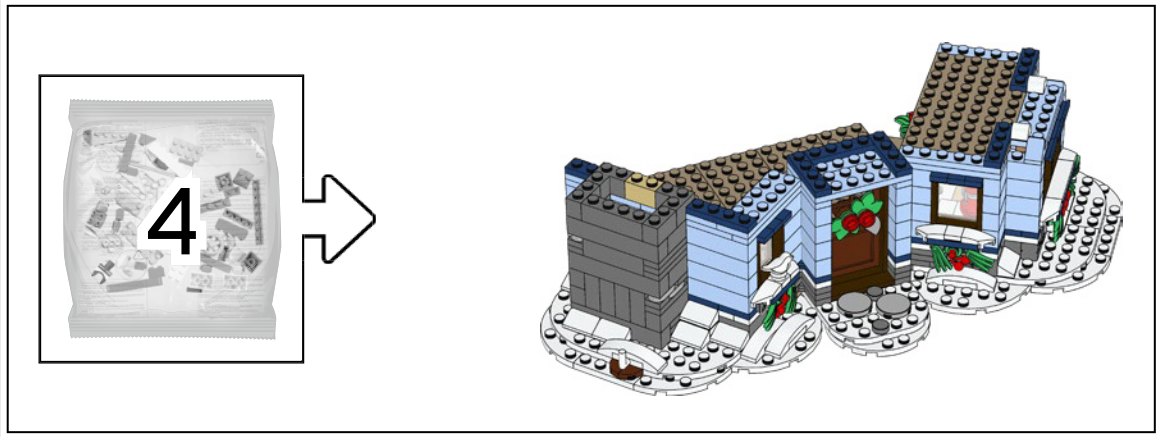

53

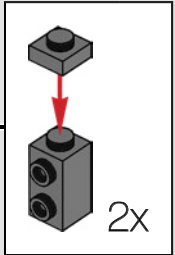

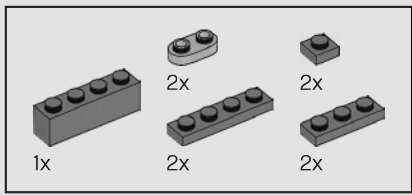

54

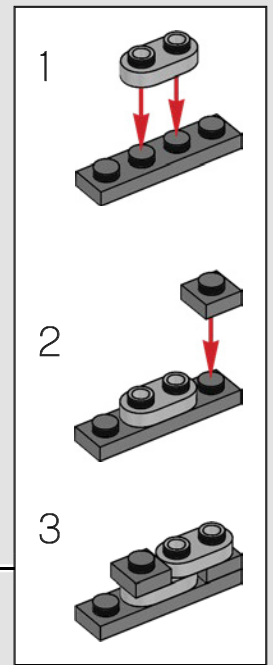
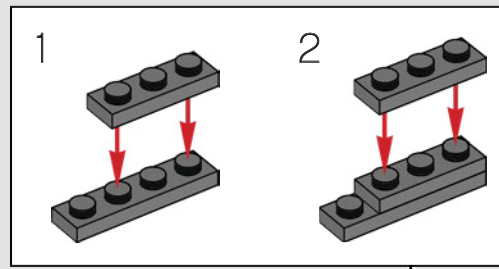

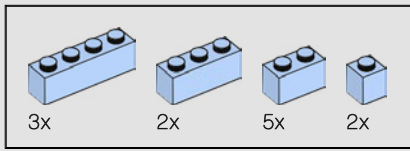

55

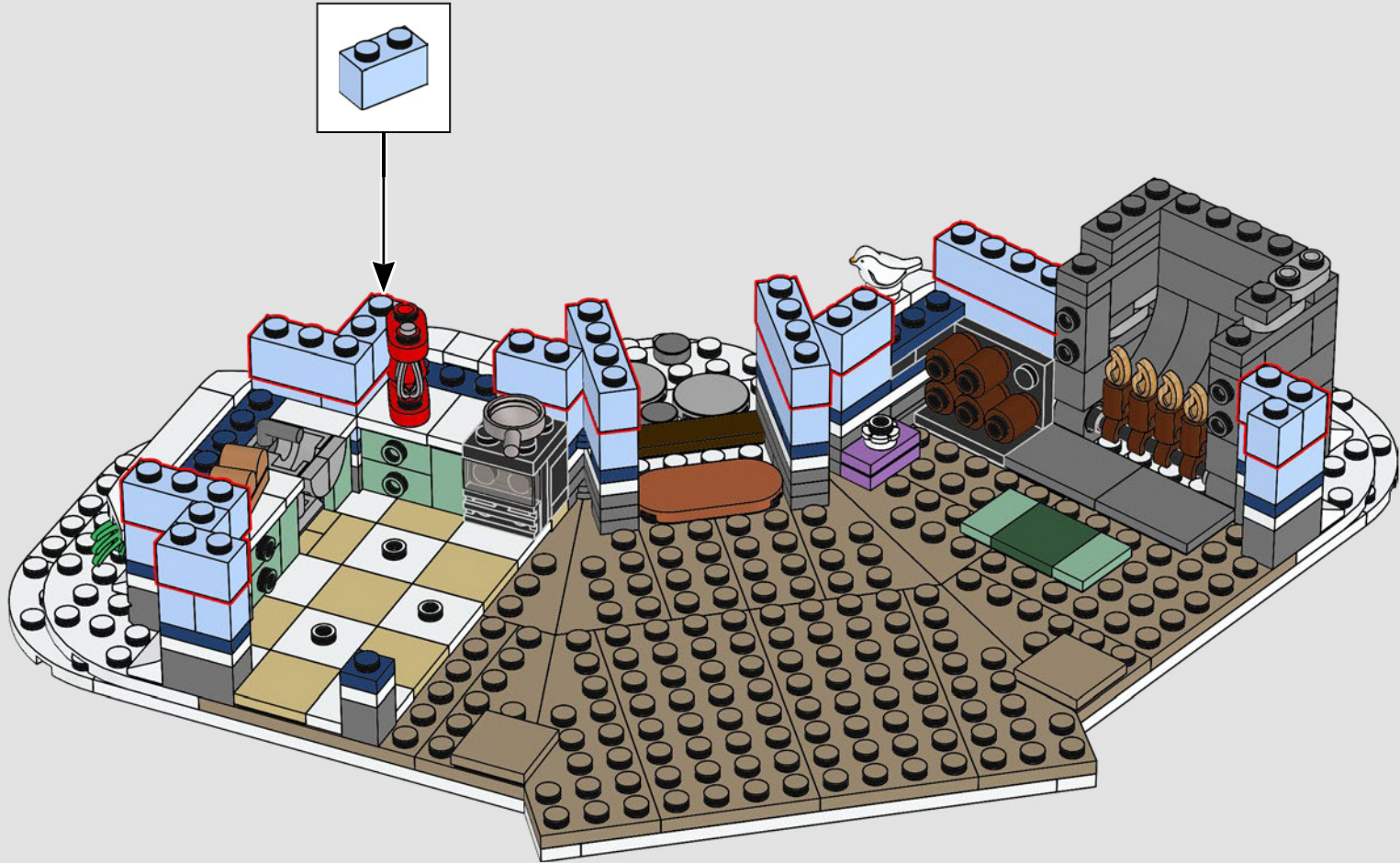

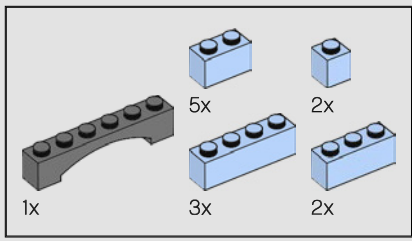

56

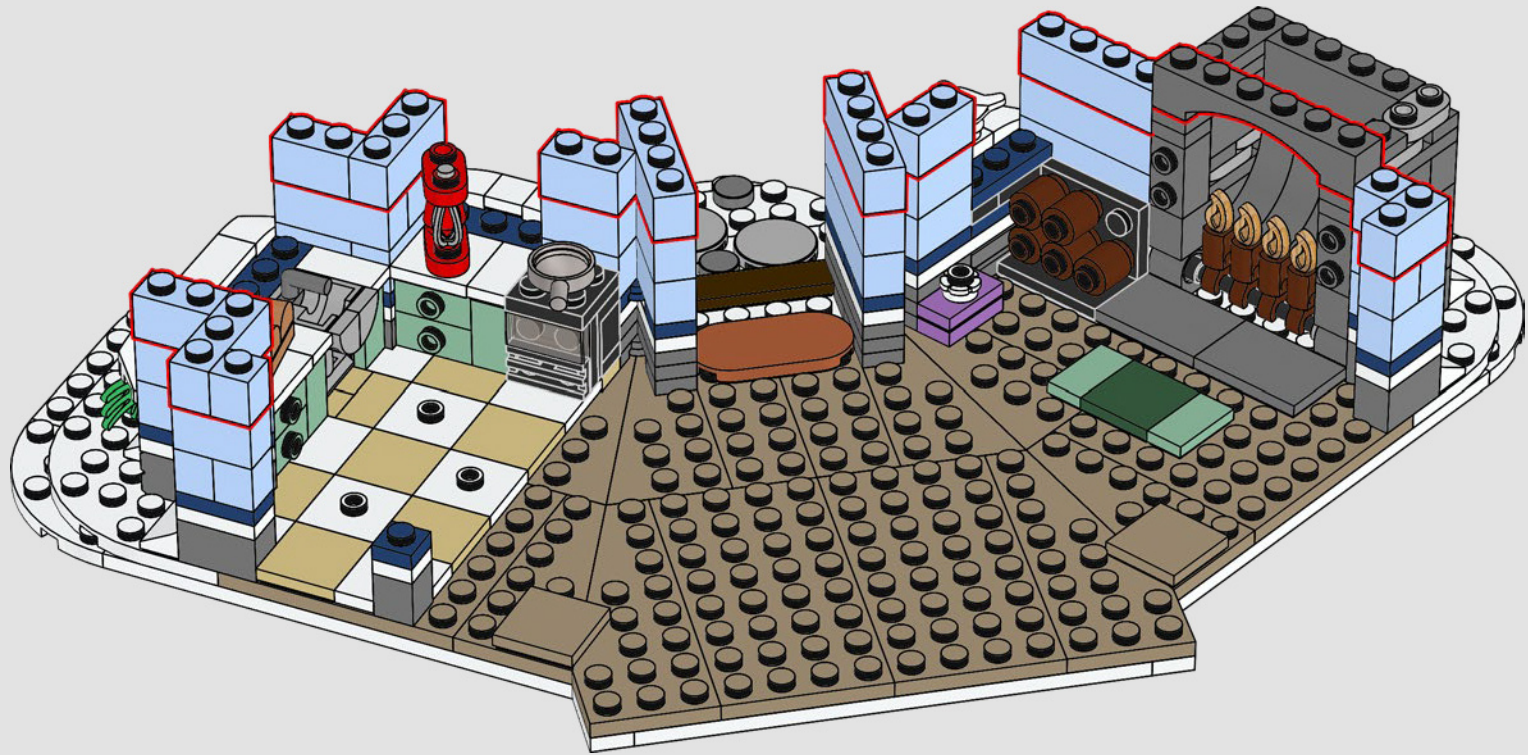

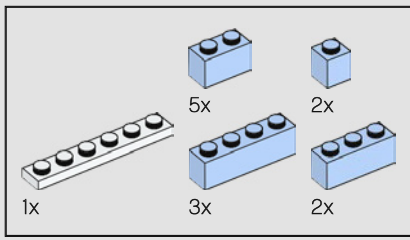

57

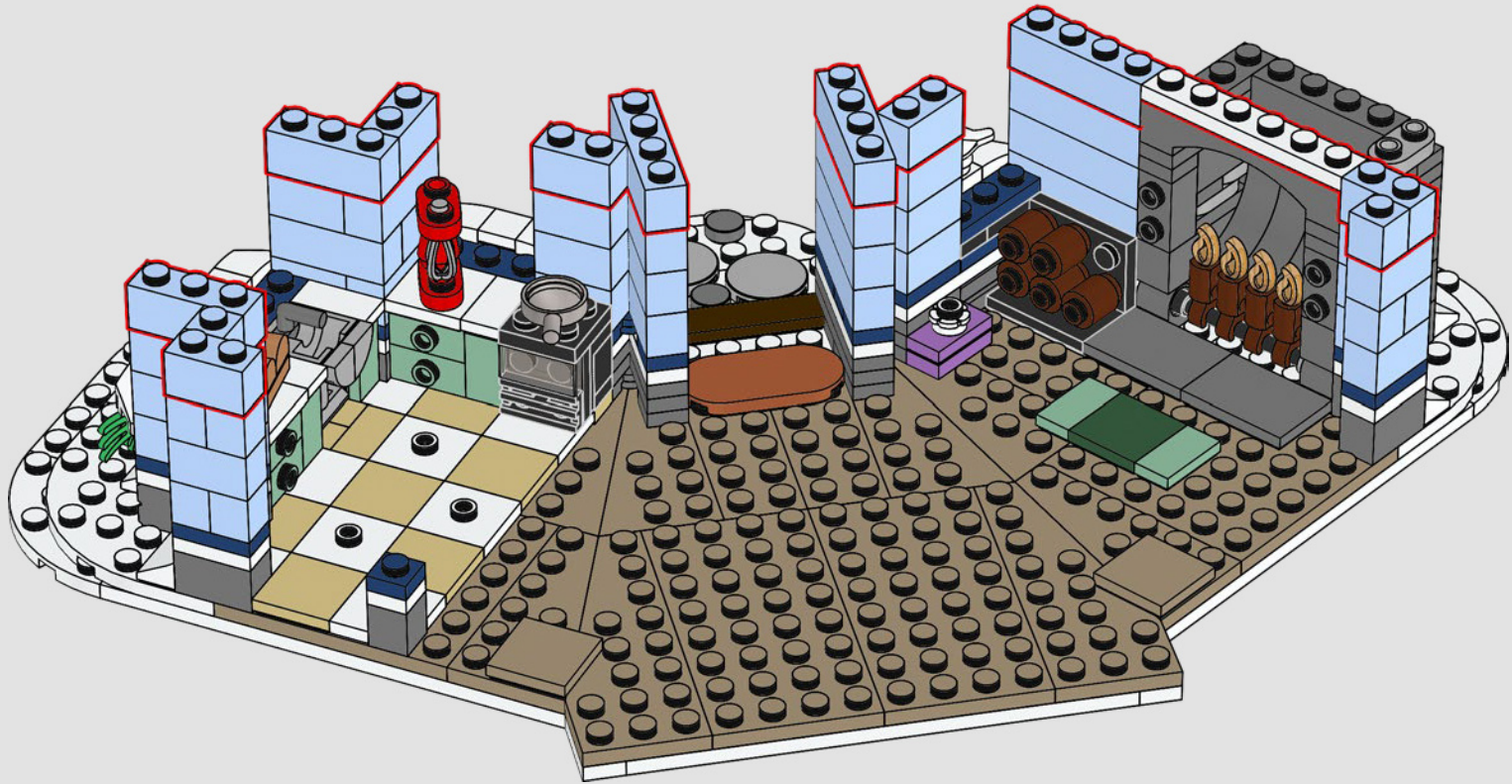

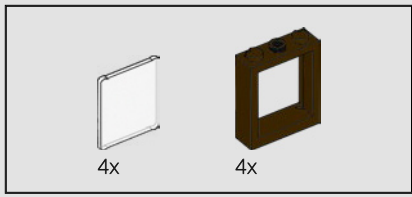

58

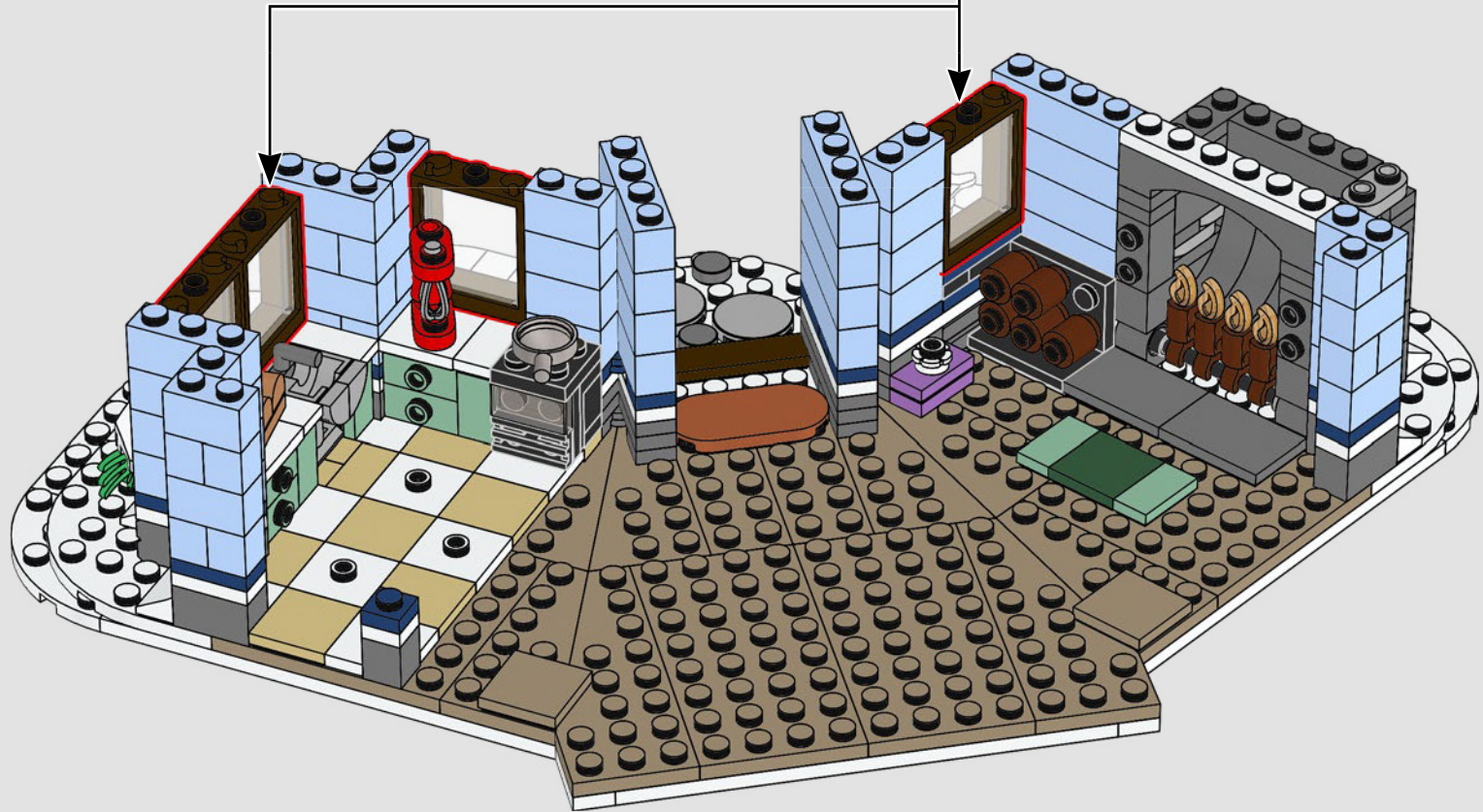
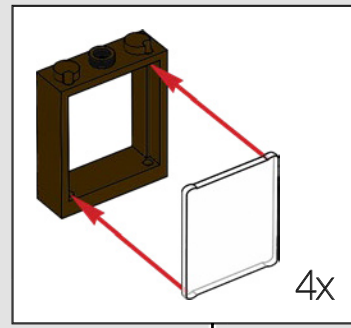

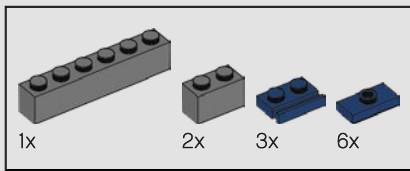

59



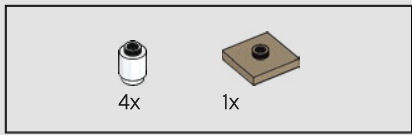

60

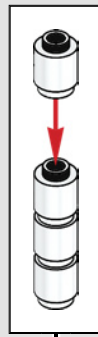

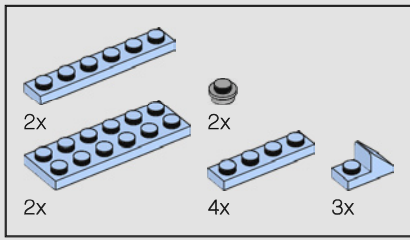

61



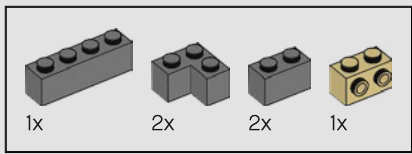

62



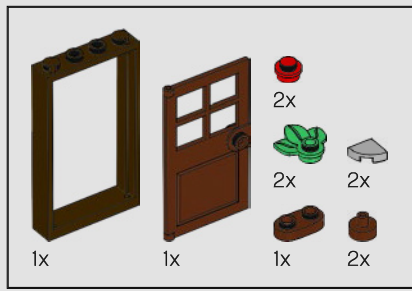

63

1

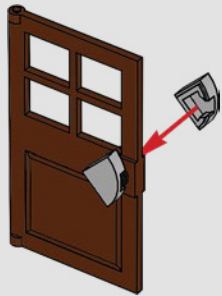

2

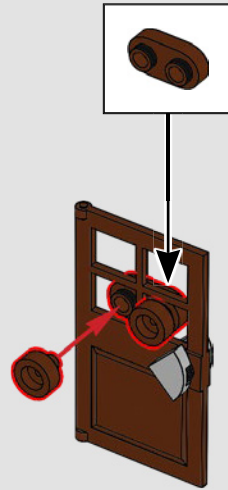

3



4



5

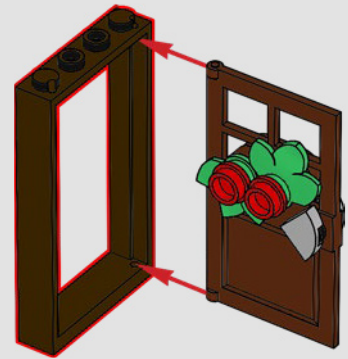

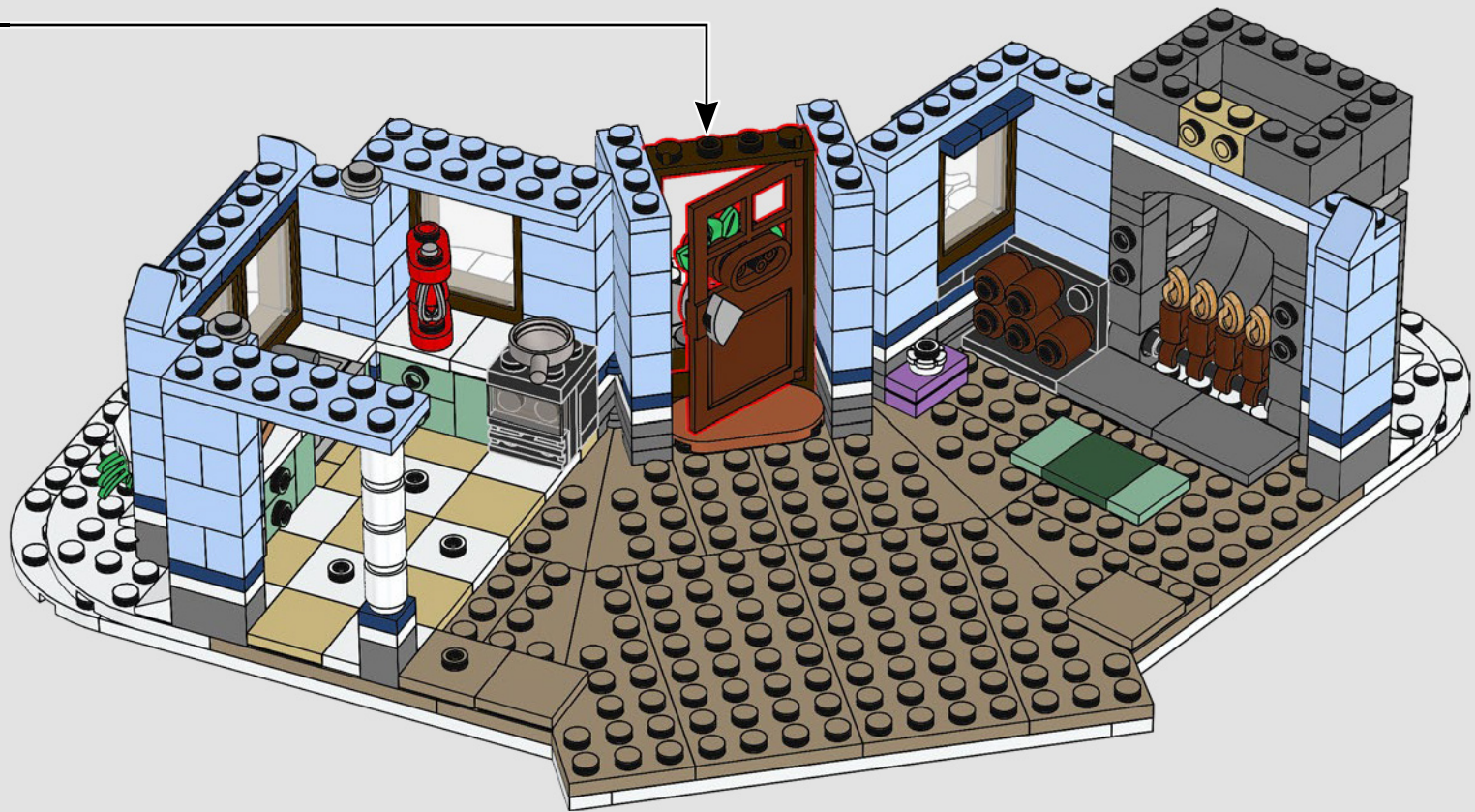

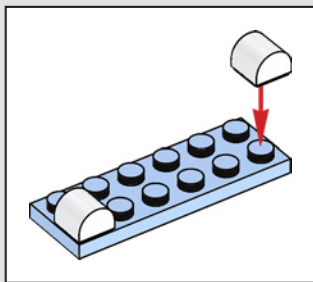
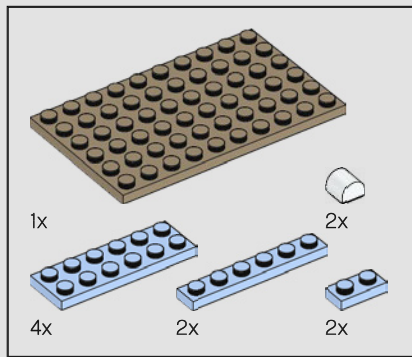

64



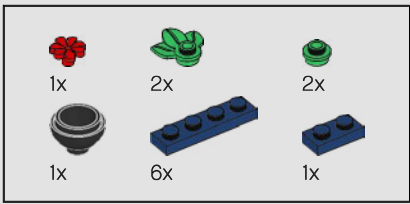

65

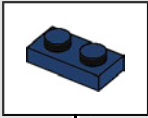
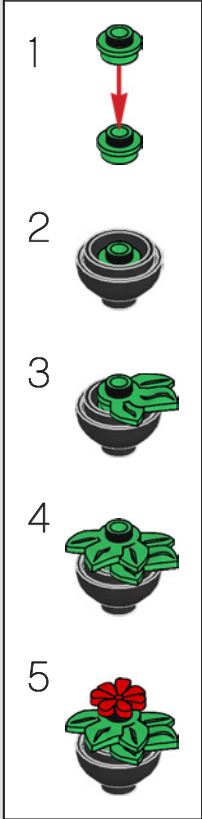

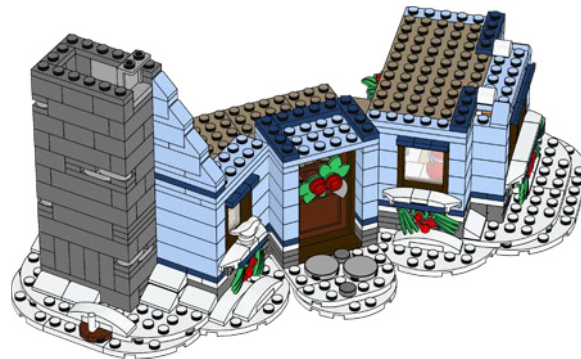

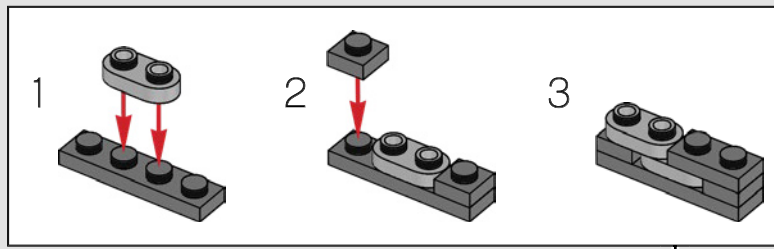
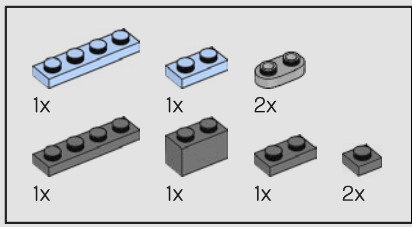

66



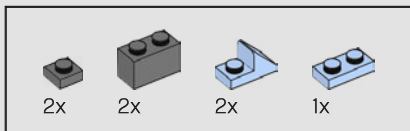

67



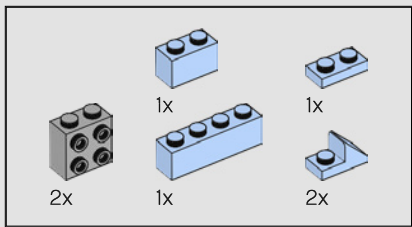

68

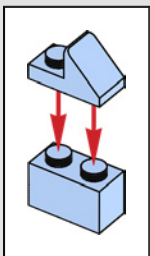
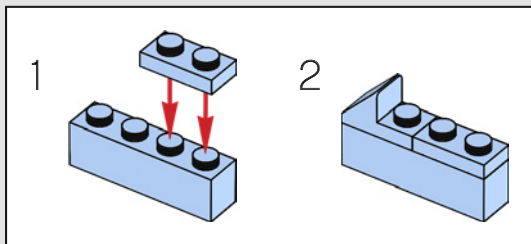

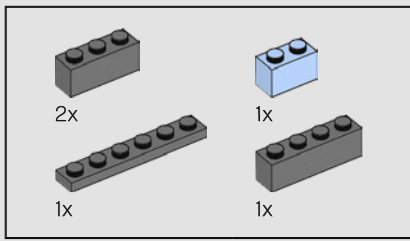

69



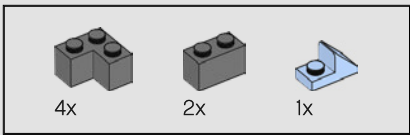

70



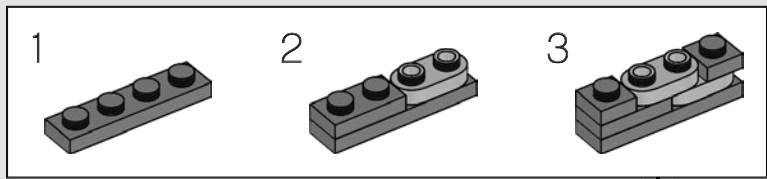
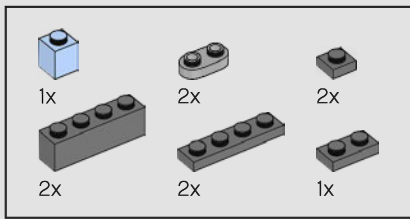

71



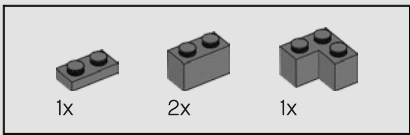

72



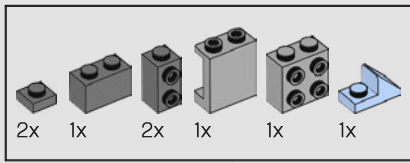

73

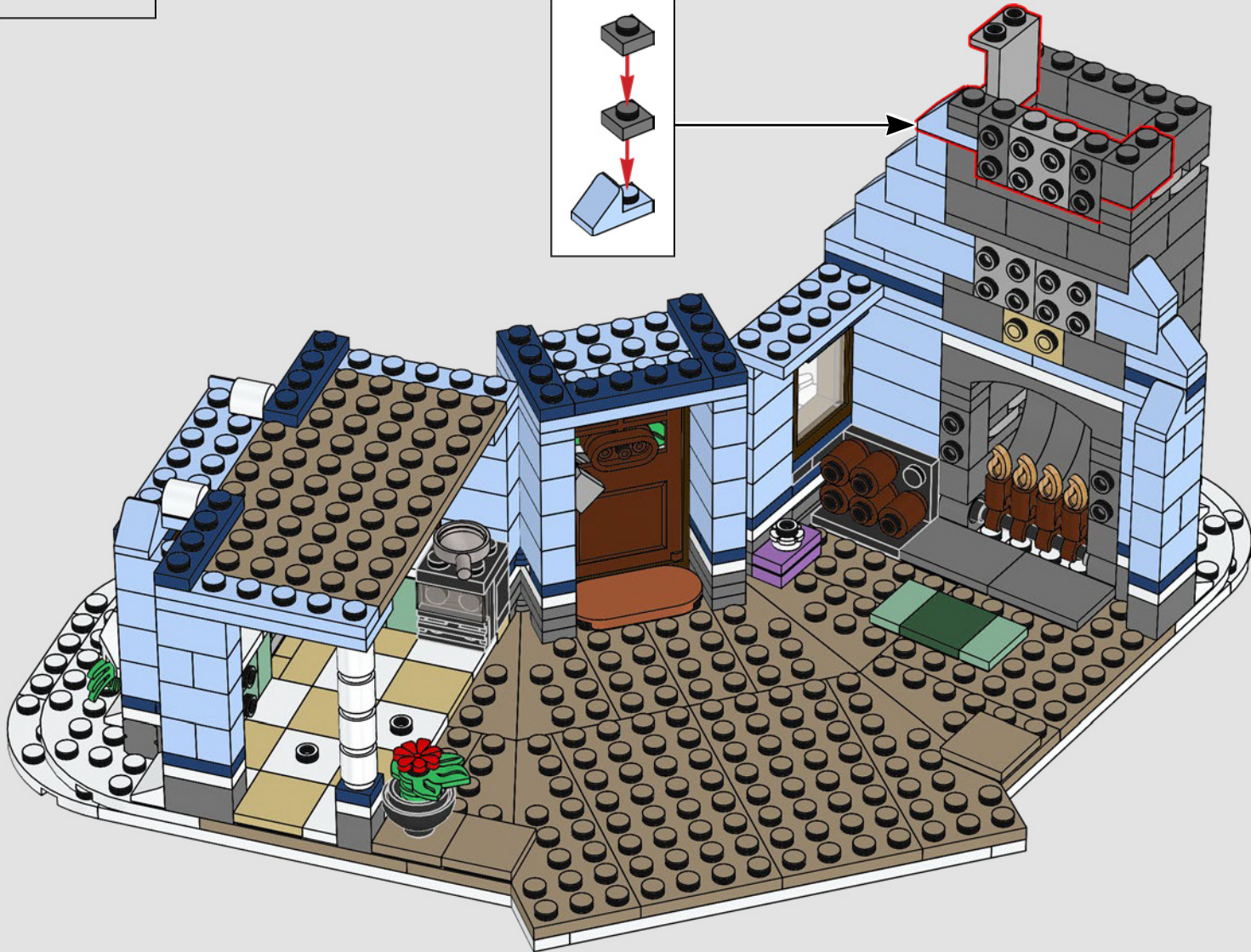
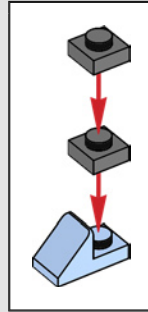

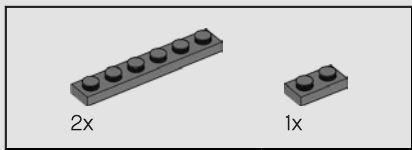

74



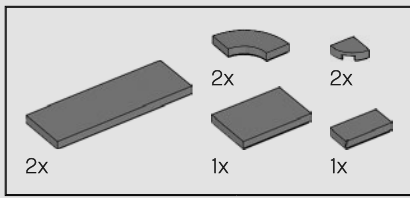

75



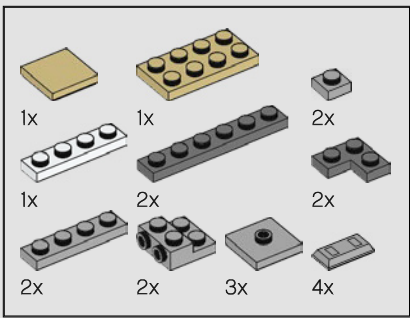

76

1

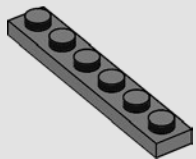

2

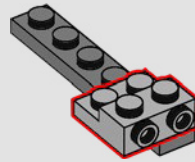

3

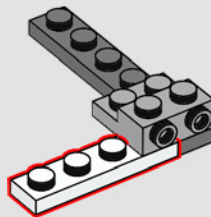

4

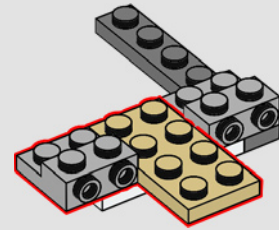

5

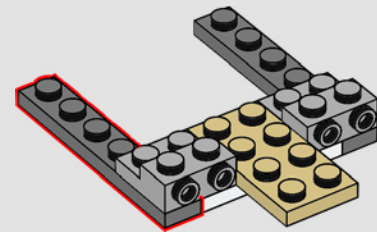

6

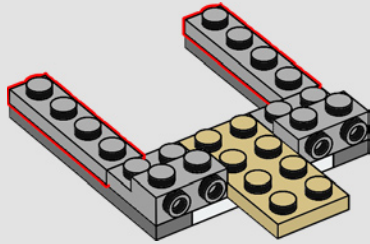

7

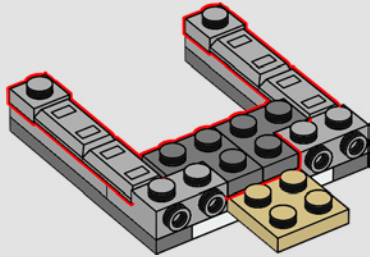

8

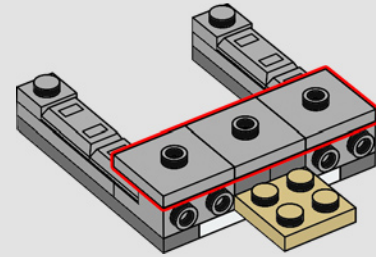

9

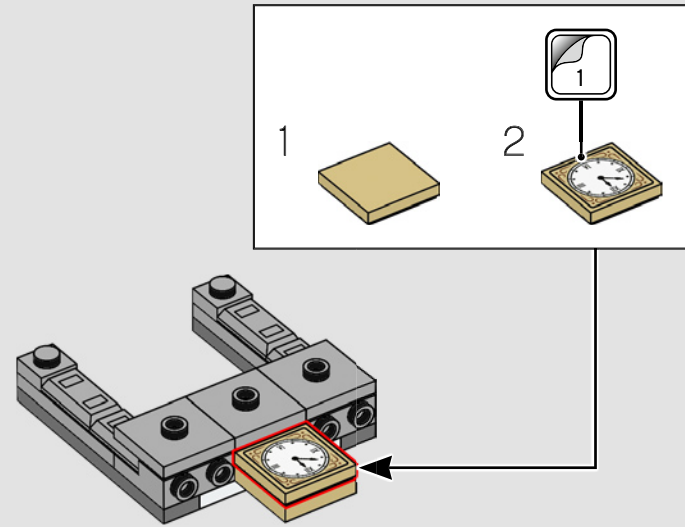



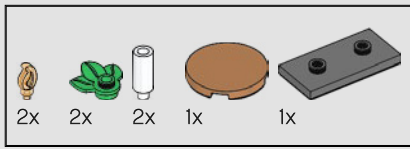

77

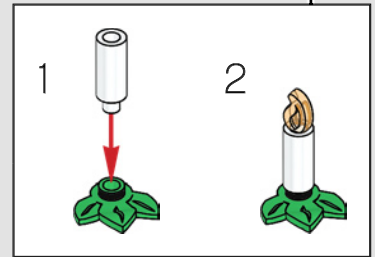
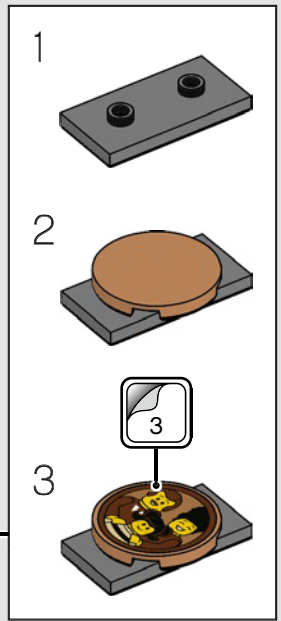
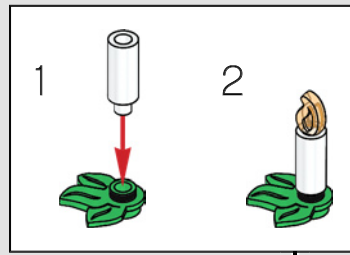

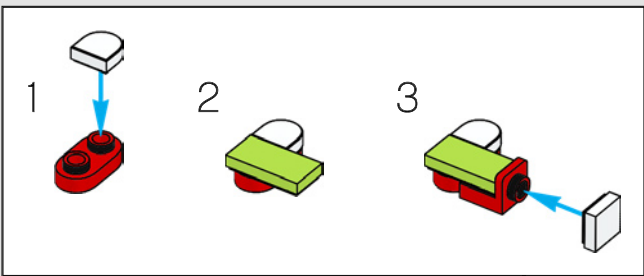
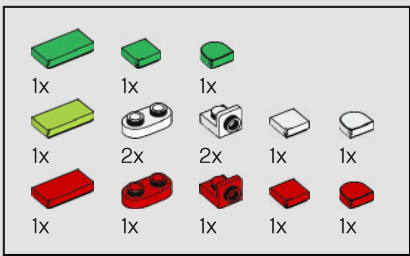

78

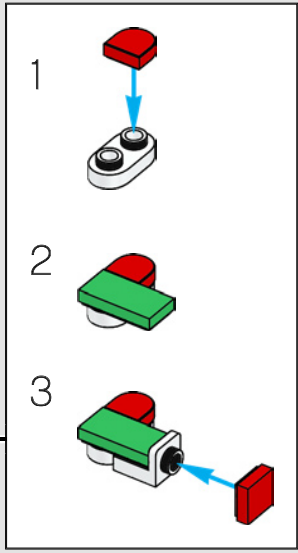
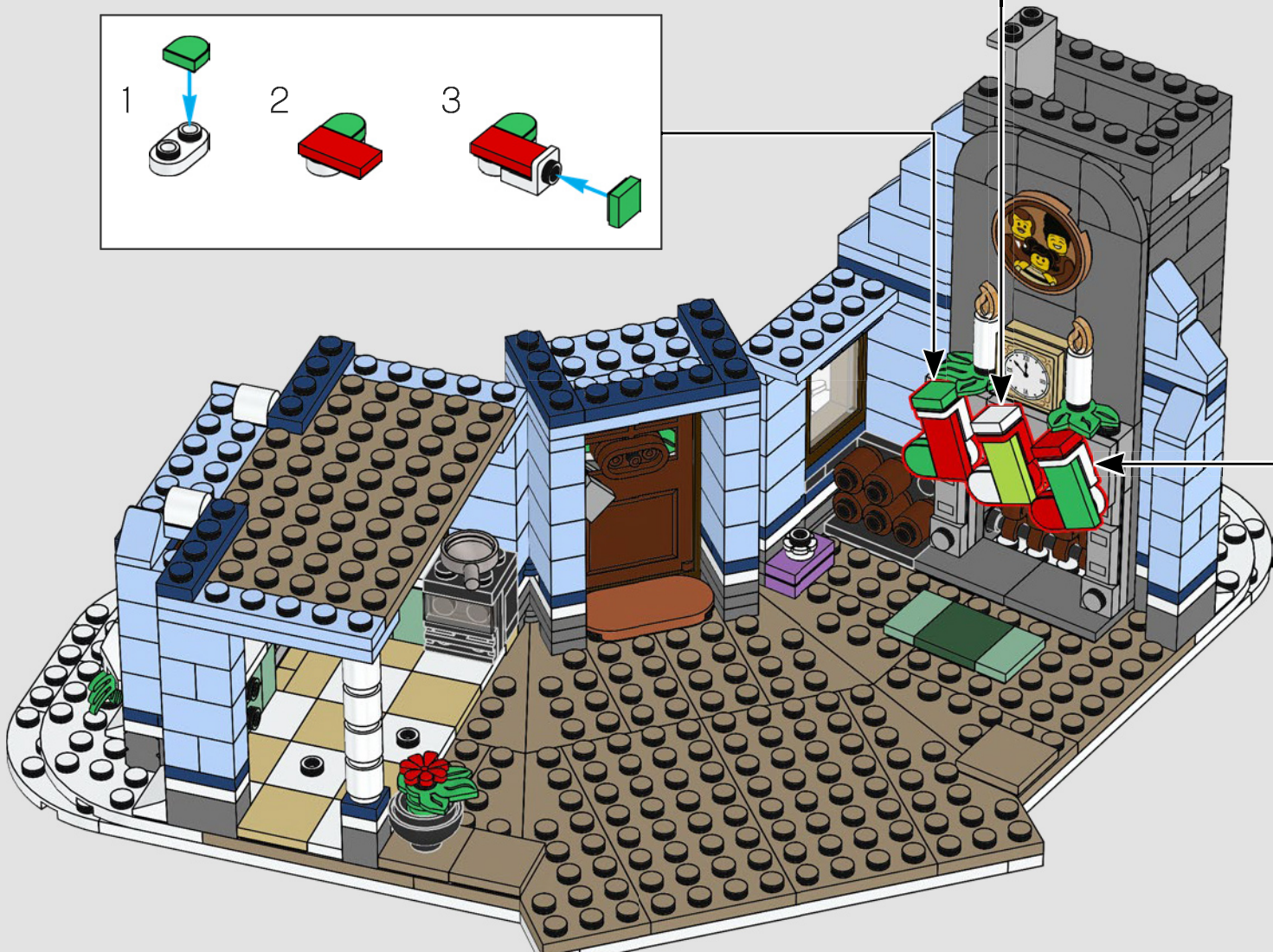
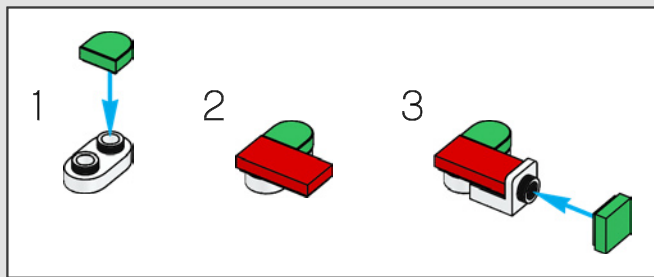

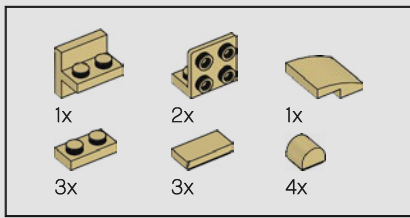

79

1

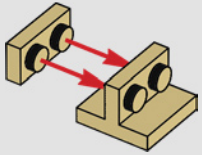

2

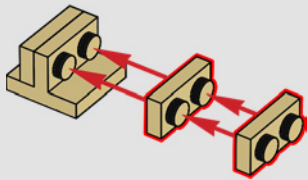

3

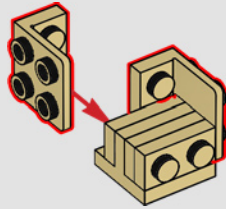

4

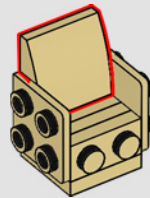

5

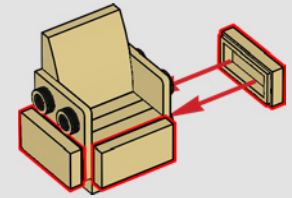

6

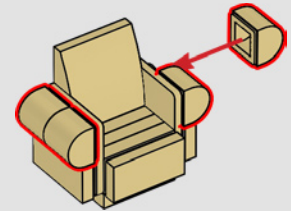

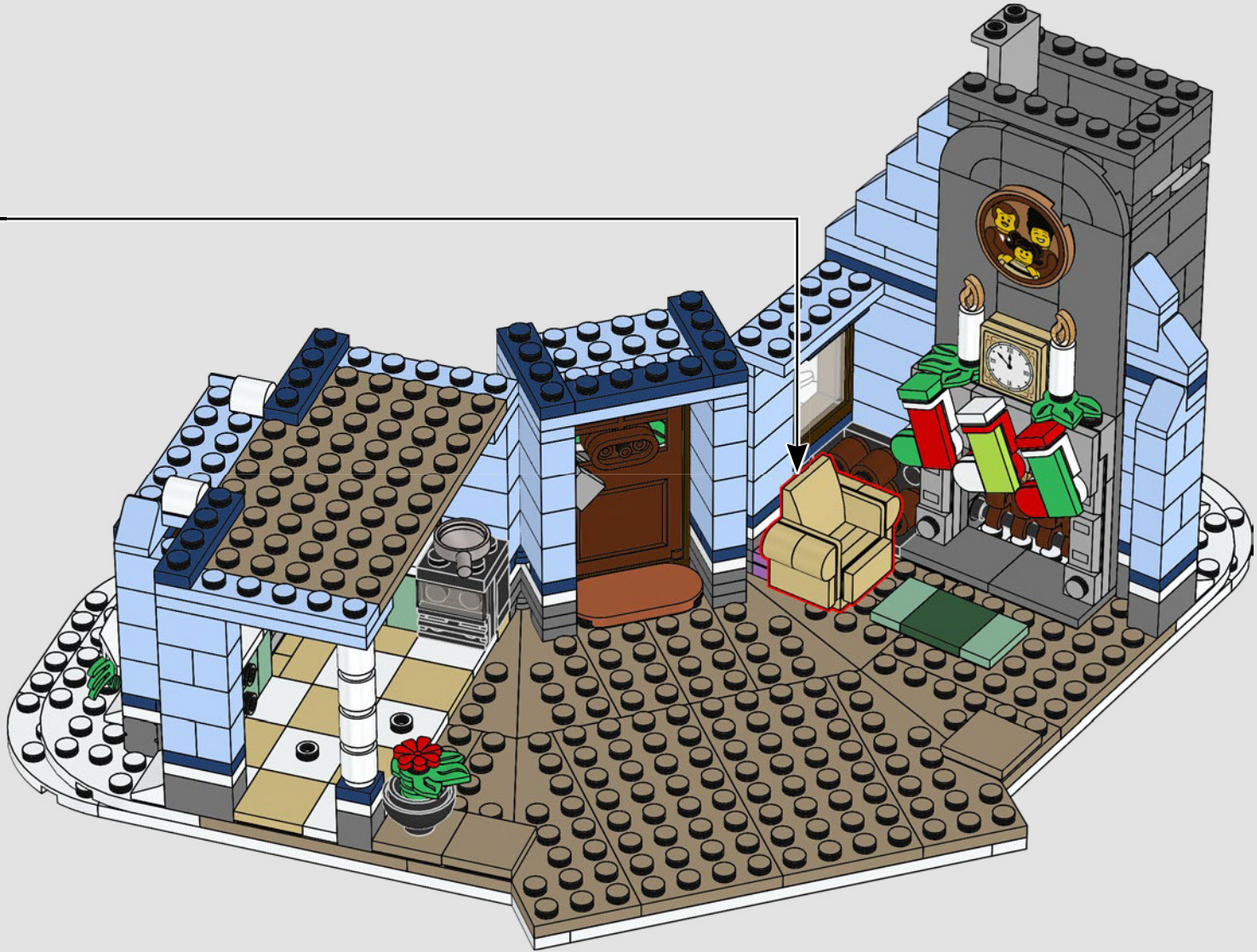

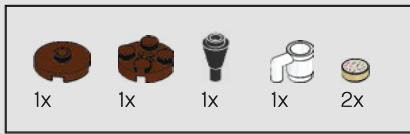

80

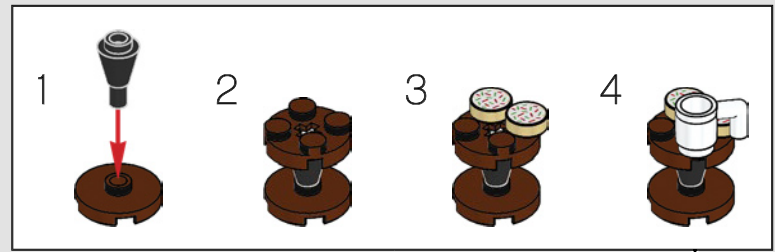

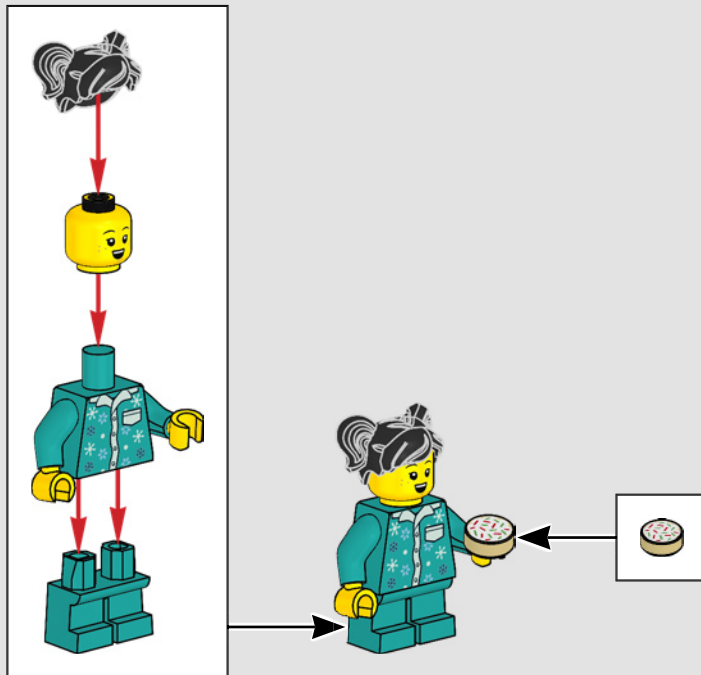
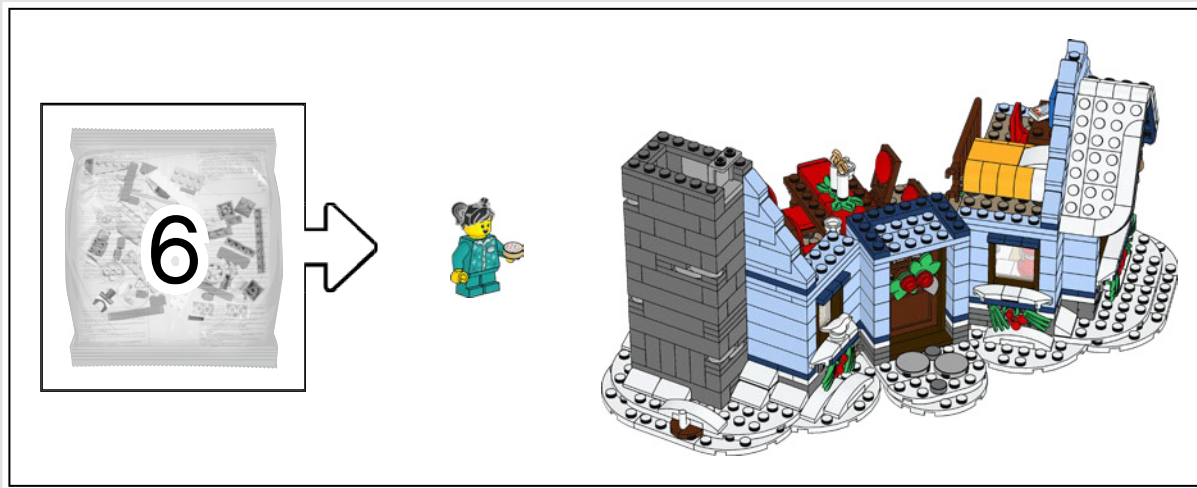

Il biscotto natalizio è basato su un vero biscotto che la madre del designer LEGO® prepara ogni anno e che lei chiama Melting Moments (Momenti Fondenti).

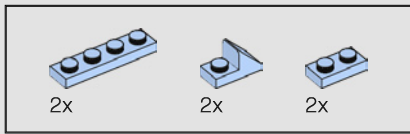

81

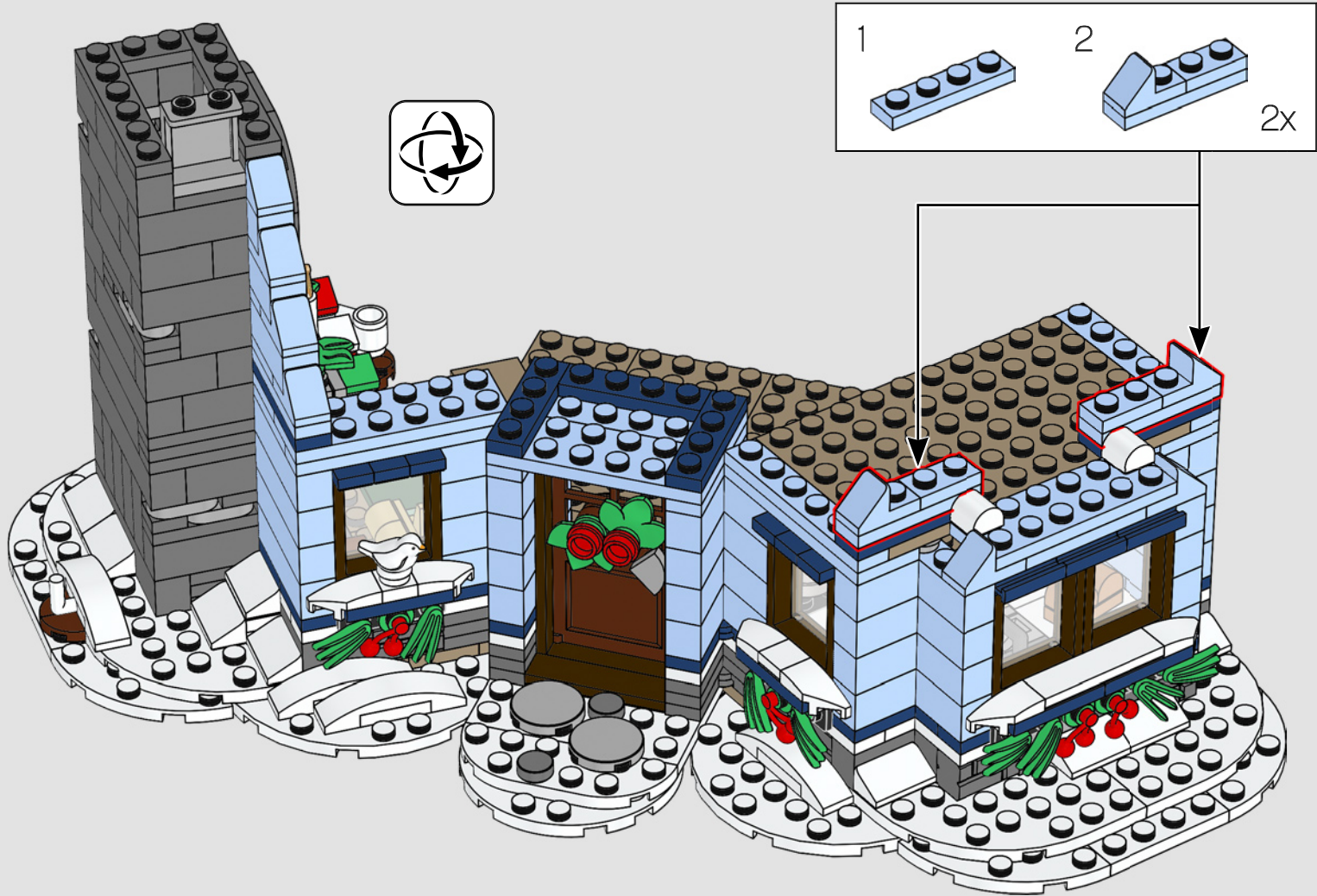

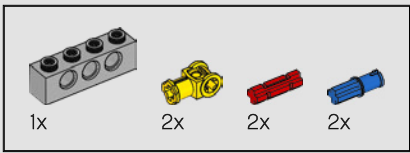

82

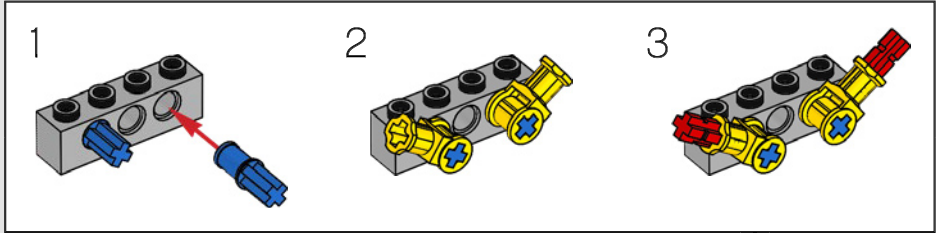

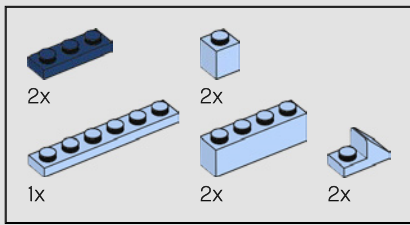

83

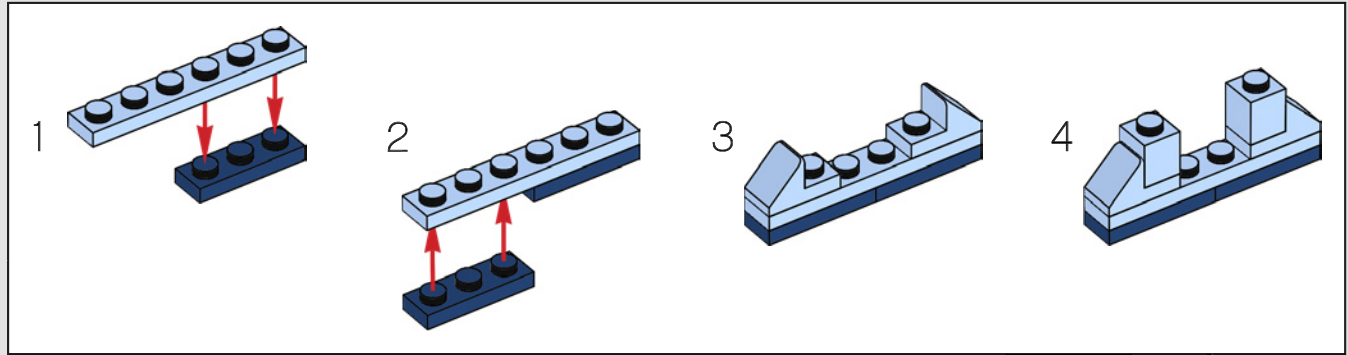

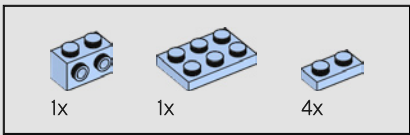

84

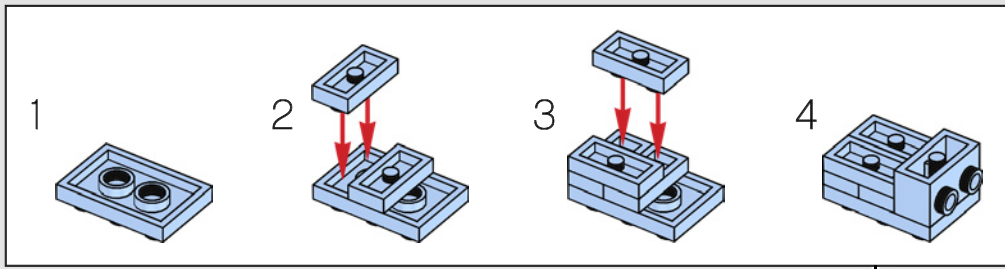

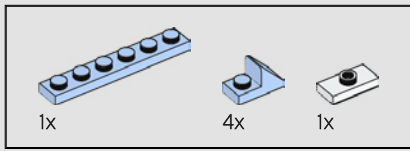

85



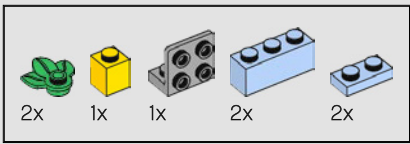

86



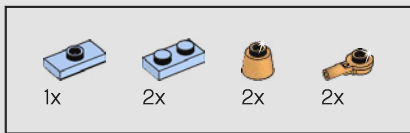

87



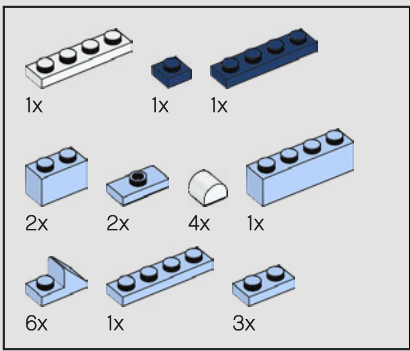

88

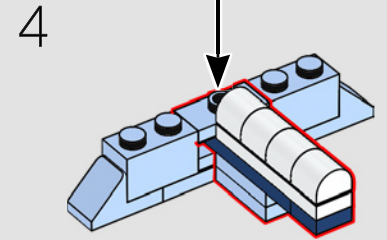
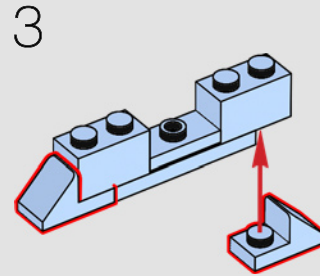
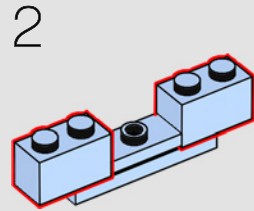
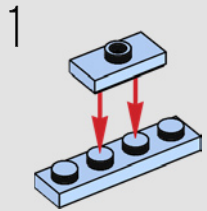
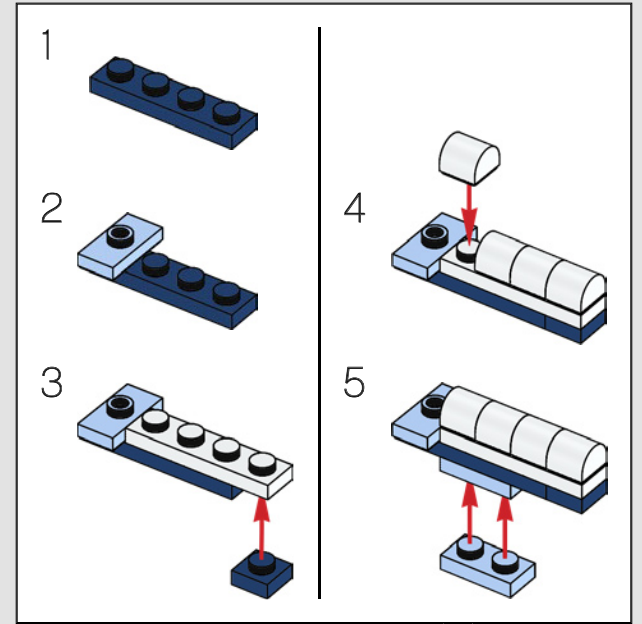

5

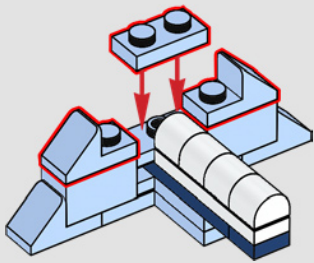

6

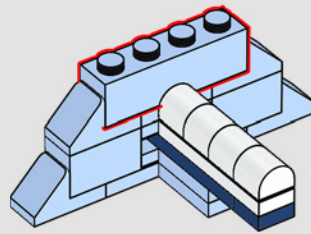

7

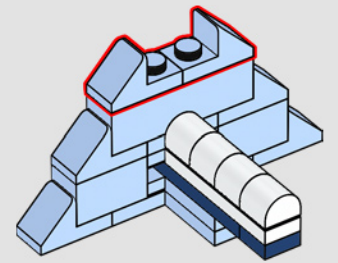



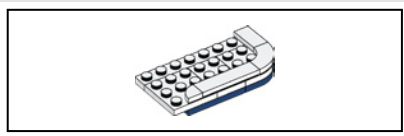

89

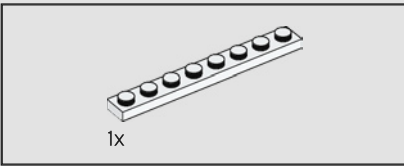

90

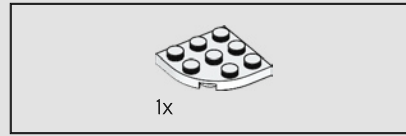
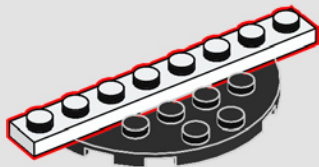

91

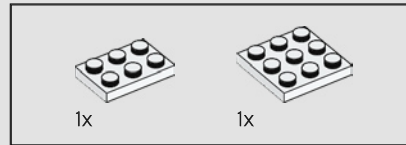
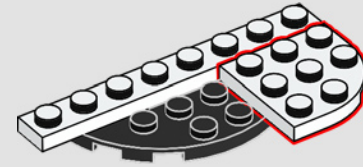

92

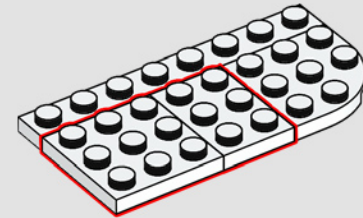

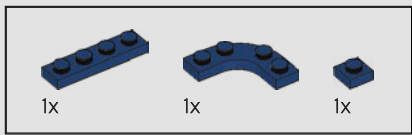

93

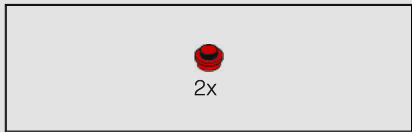
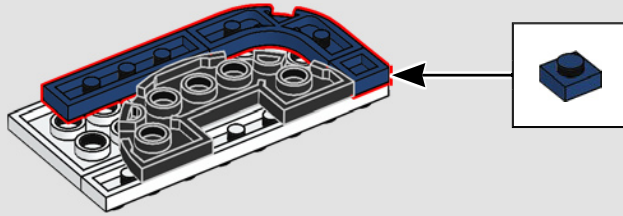

94

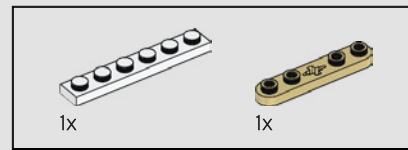
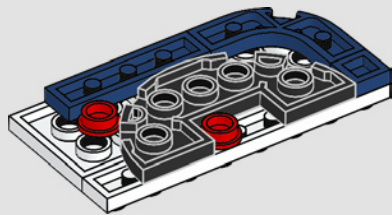

95

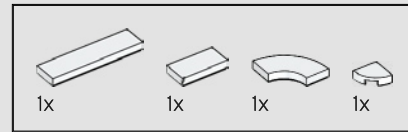
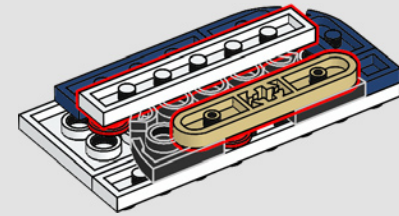

96

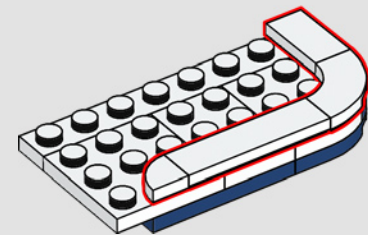
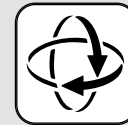



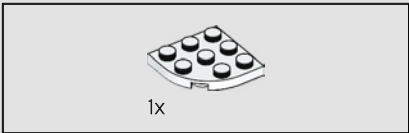
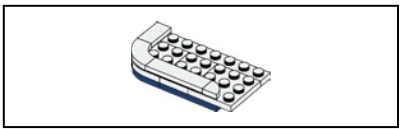

1x

100

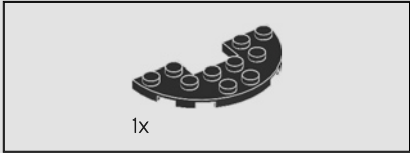

1x

98

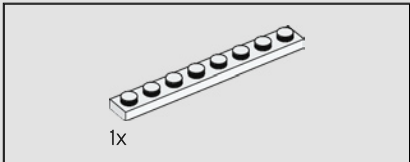
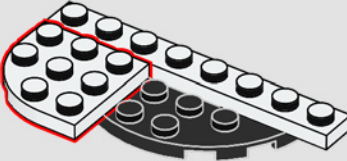

1x

99

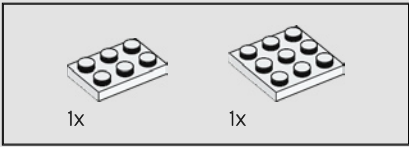
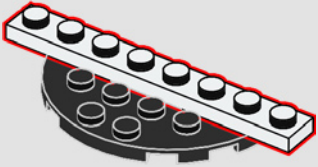

1x

1x

101

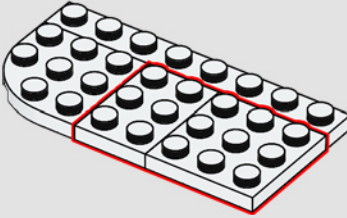

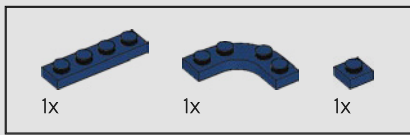

102

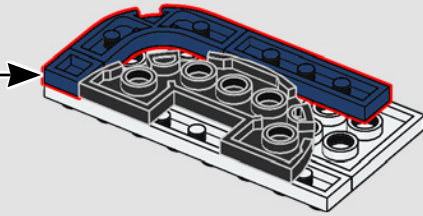
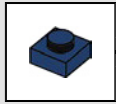

103

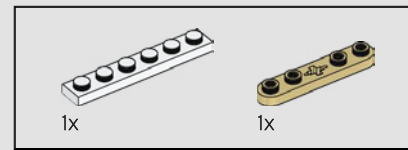
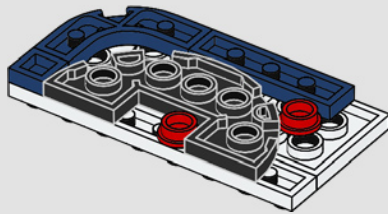

104

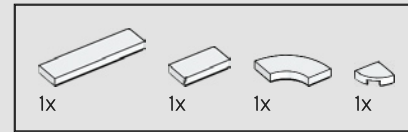
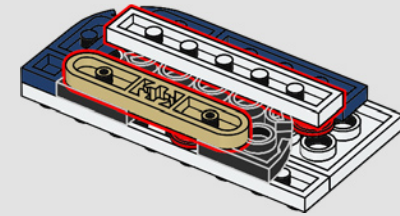

105

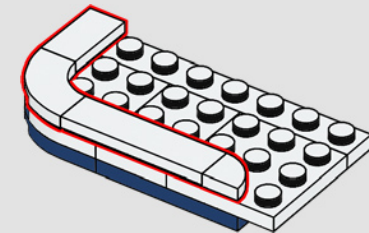
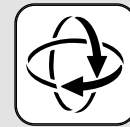



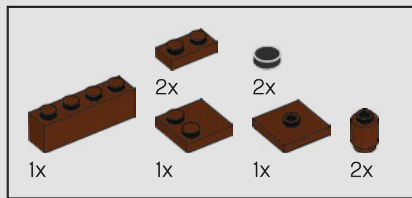

107

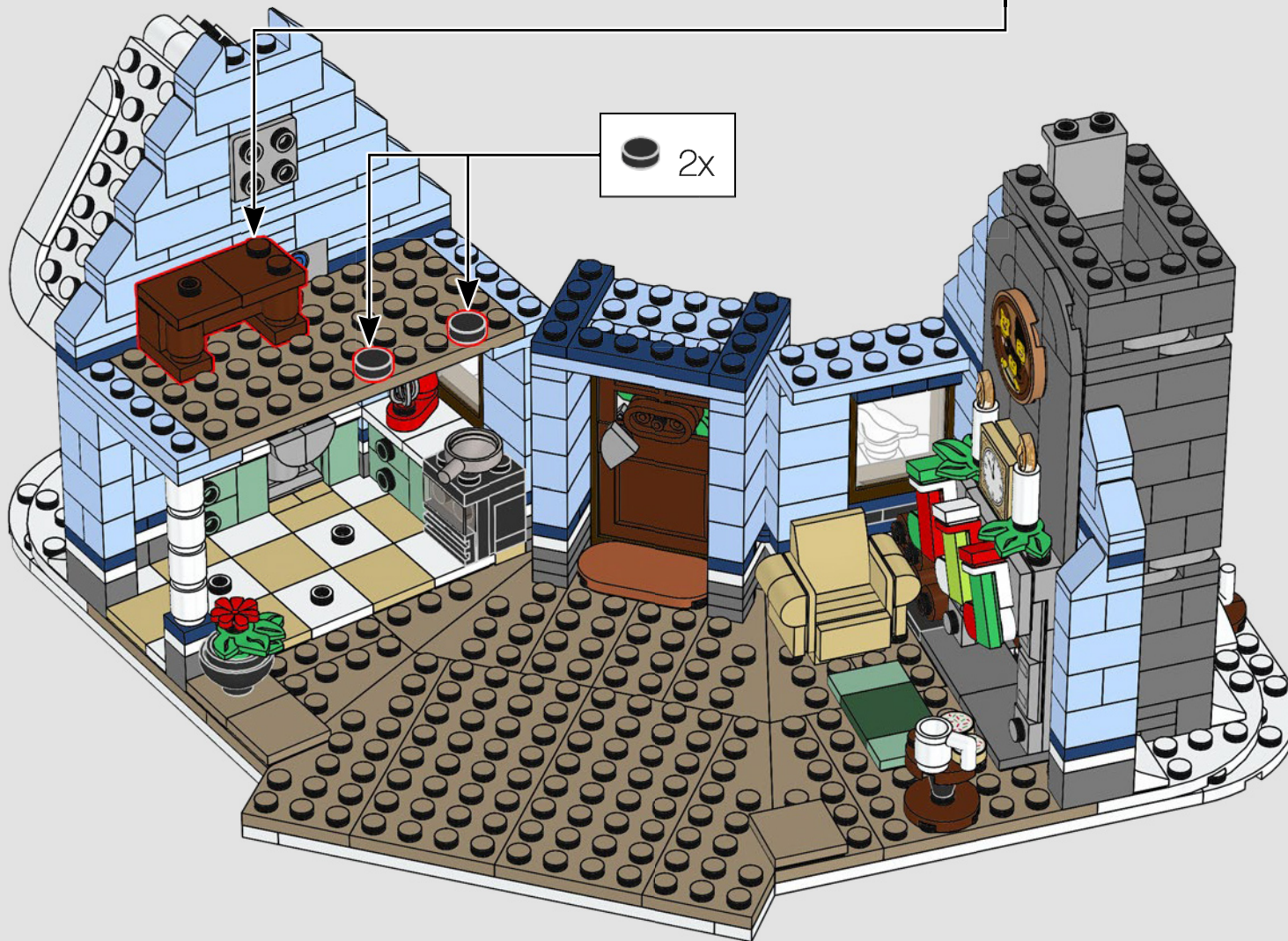
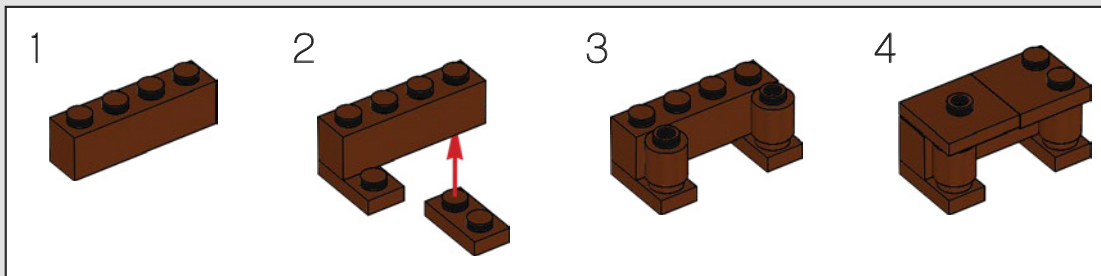

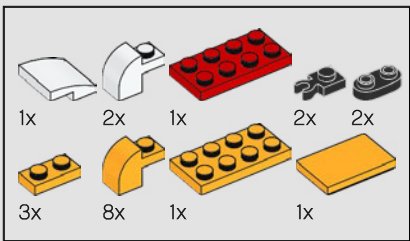

108

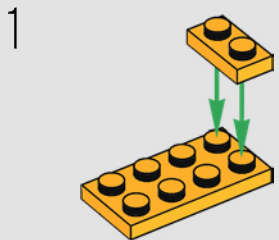

2

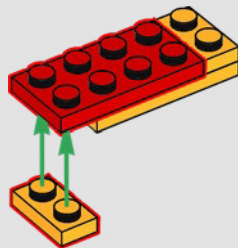

3

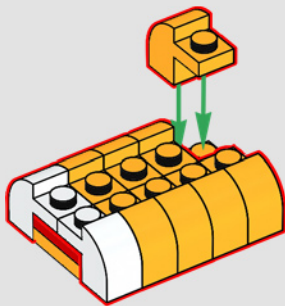

4

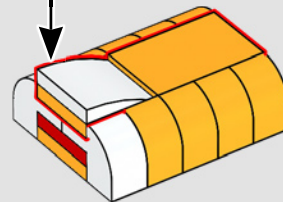
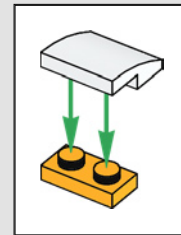

5

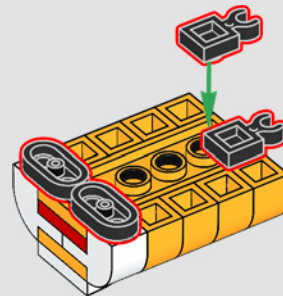



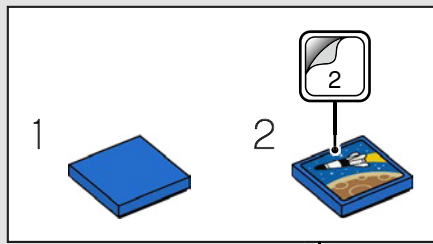
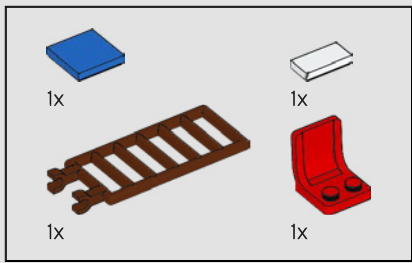

109

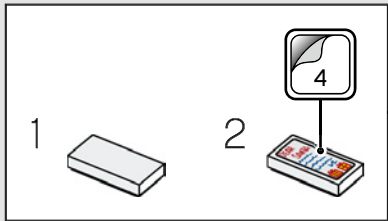

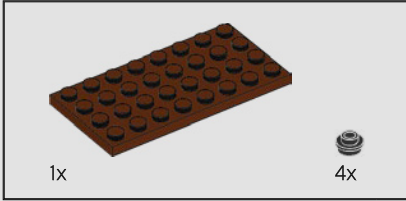

110

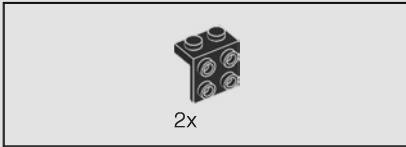
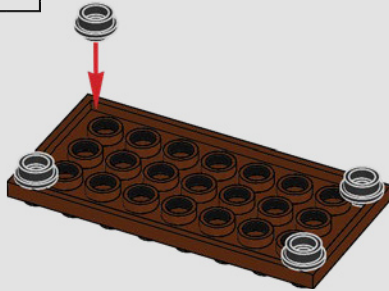

111

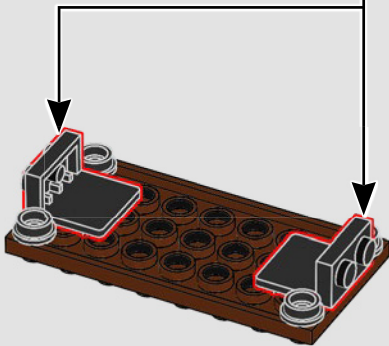
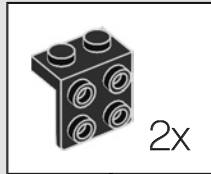

112

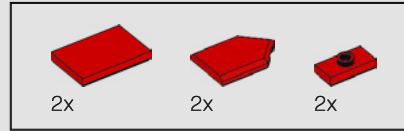
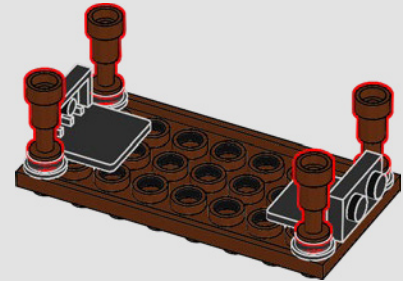

113

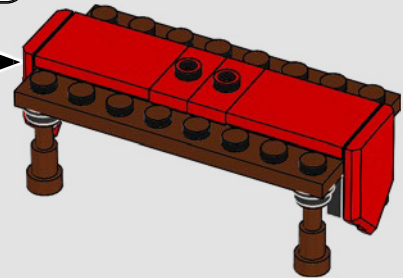
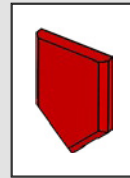
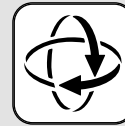

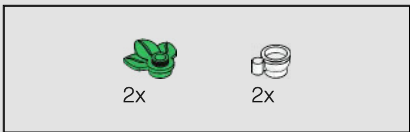

114

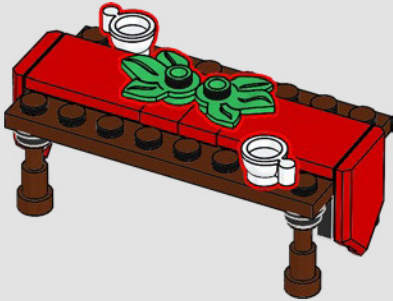

115

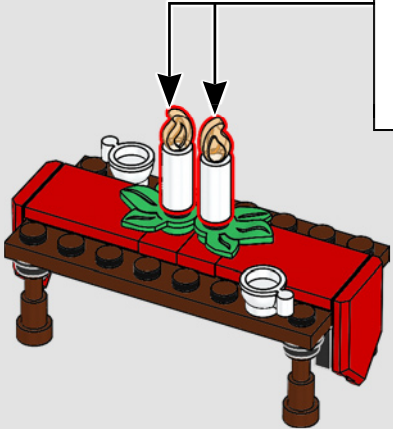
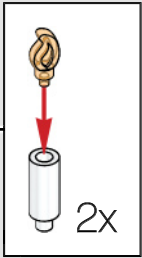

116



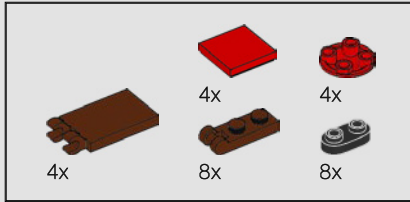

117

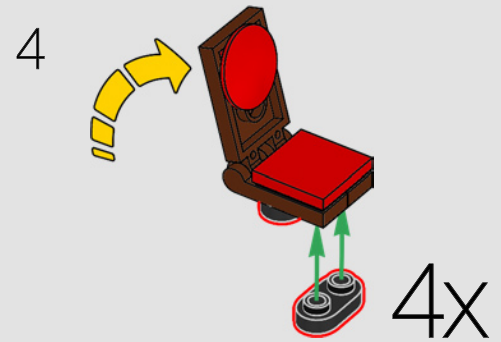
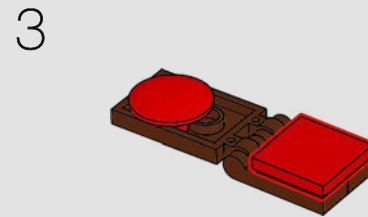
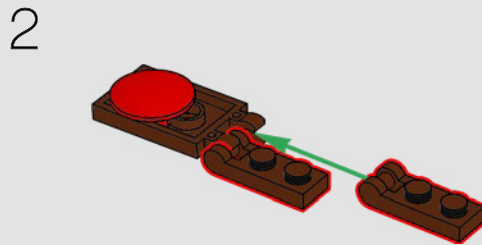
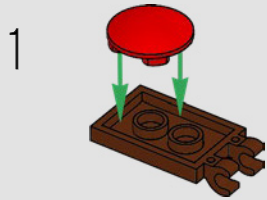



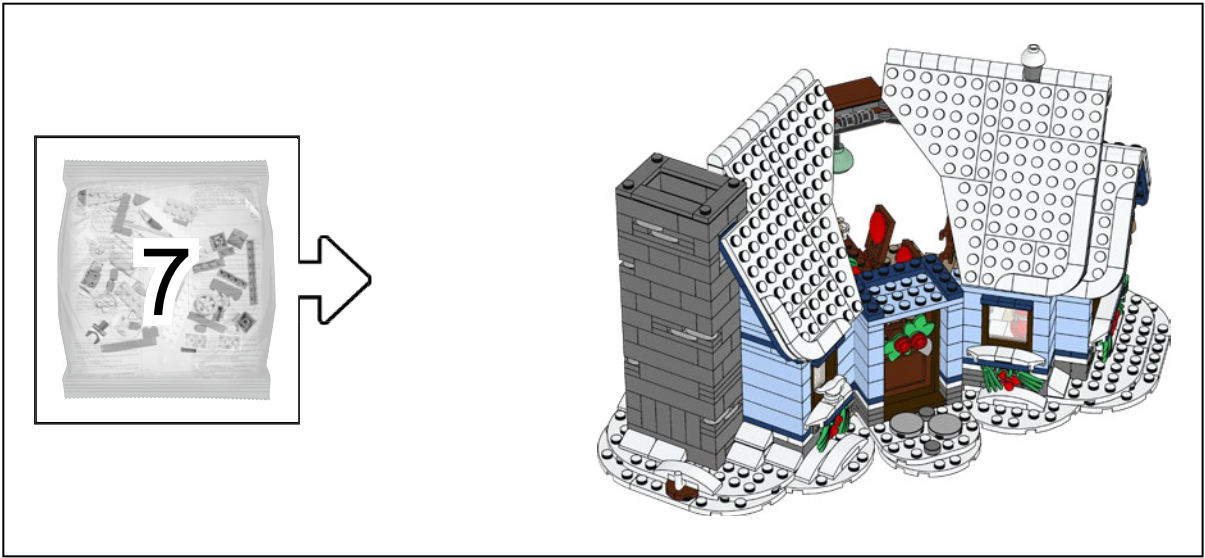

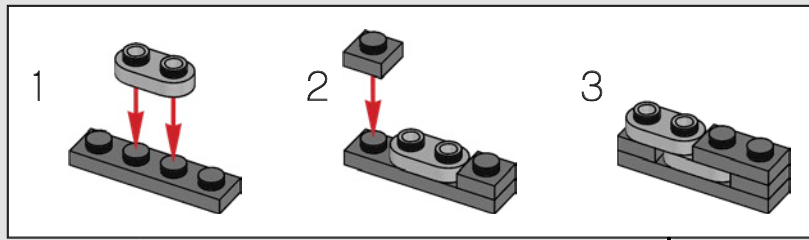
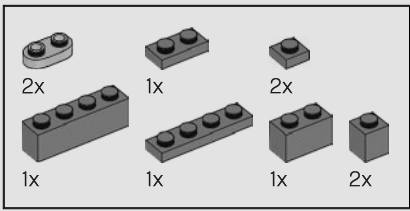

118

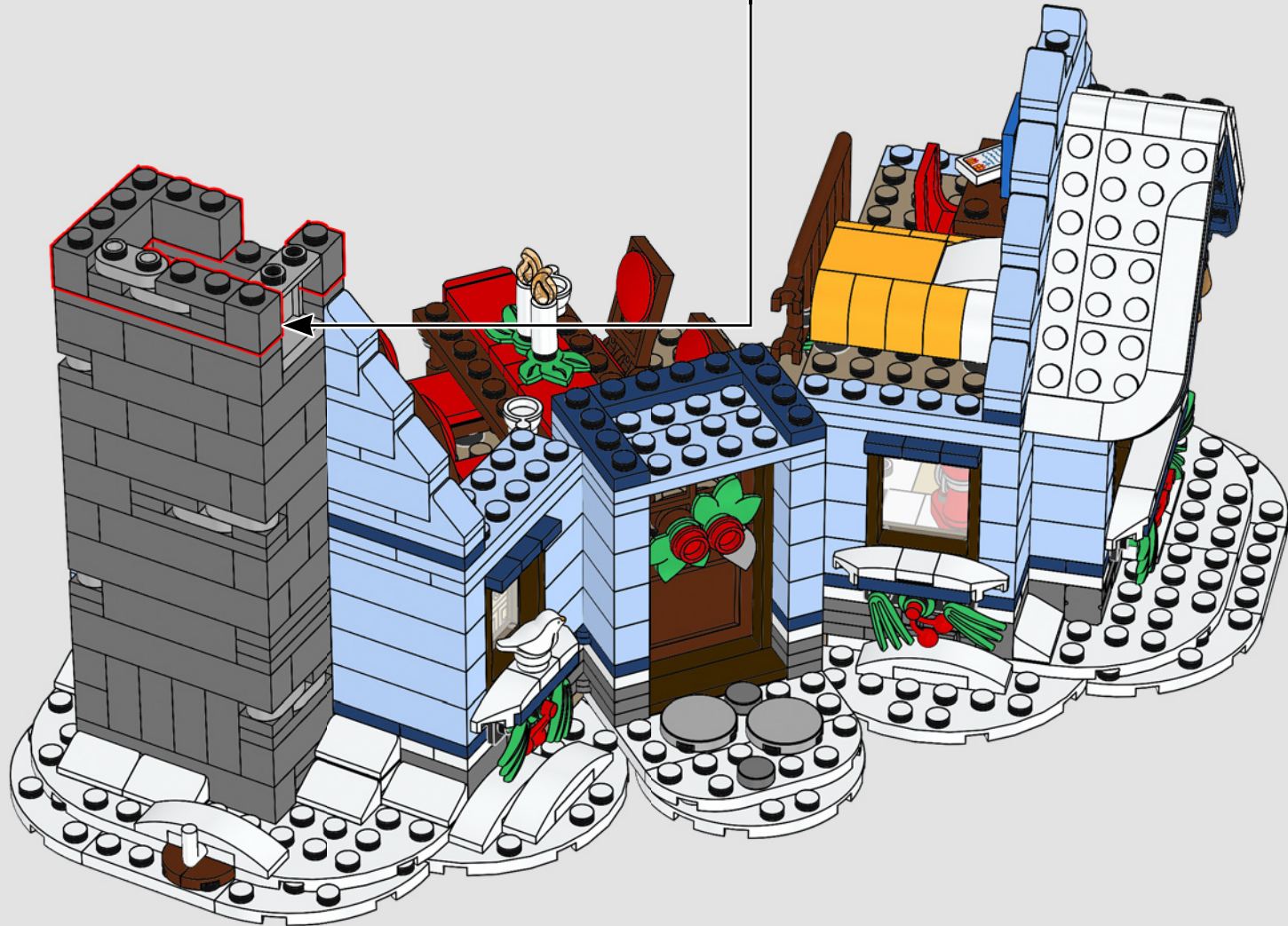
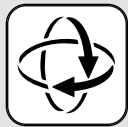

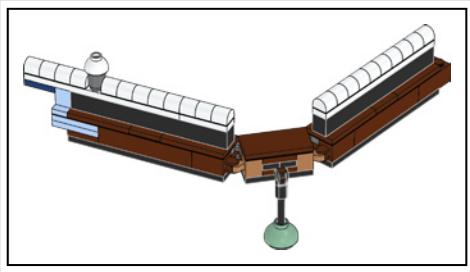

119

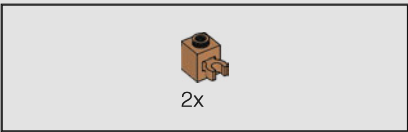
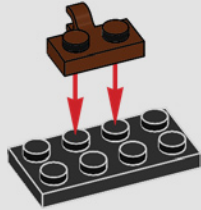

120

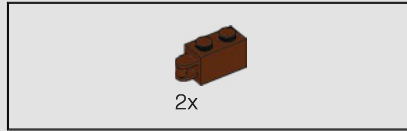
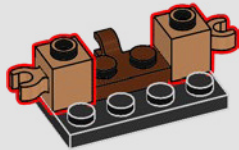

121

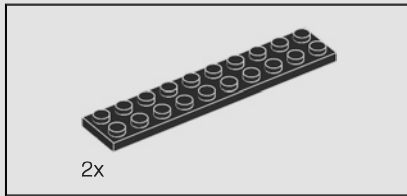
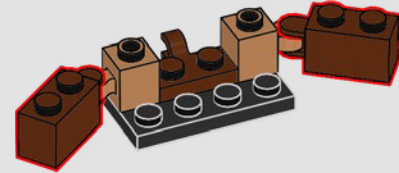

122

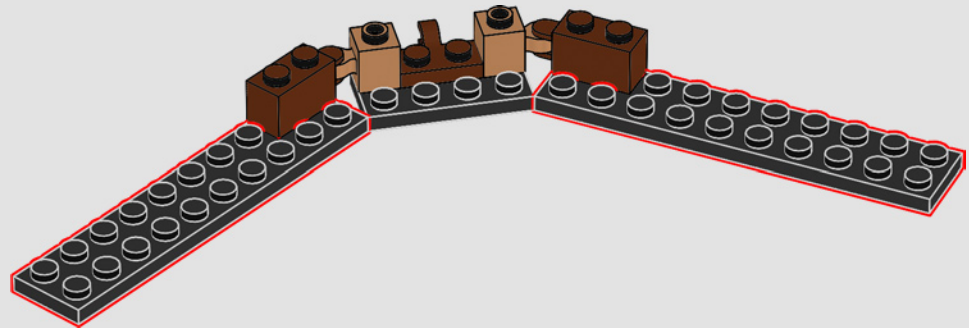

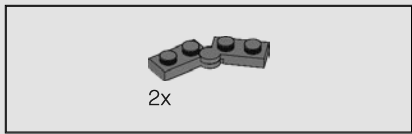

123

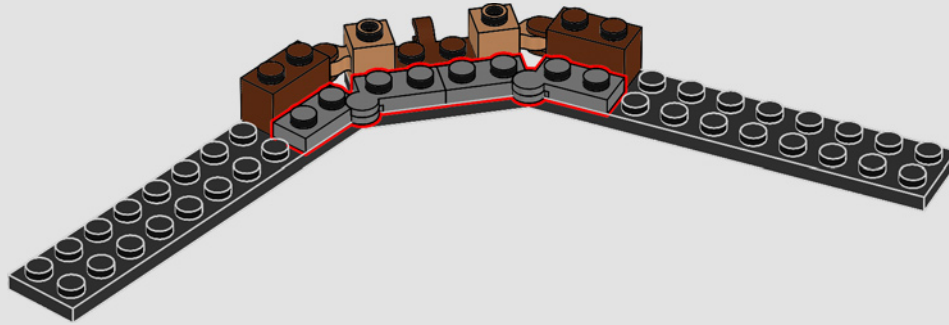

124

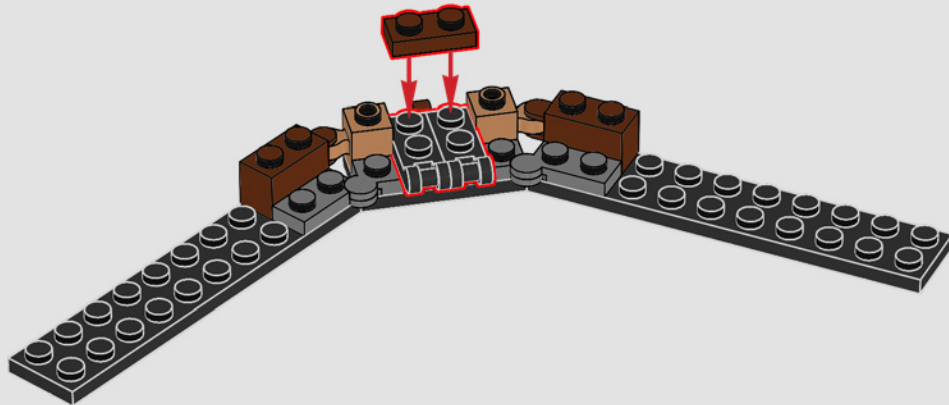

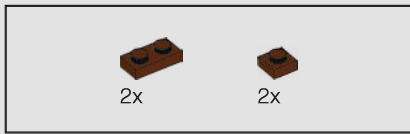

125

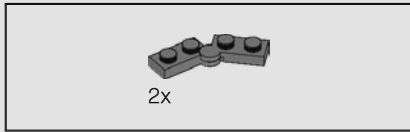

126

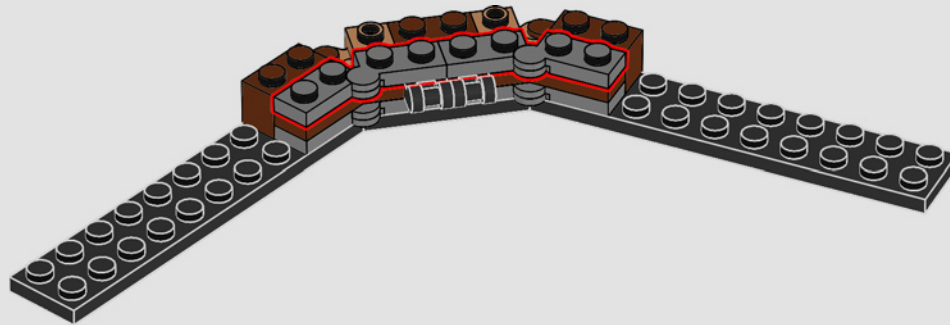

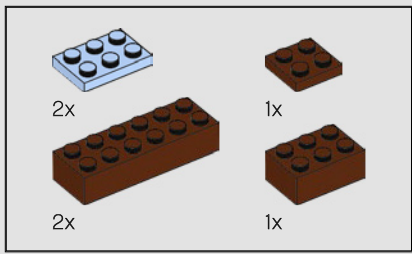

127

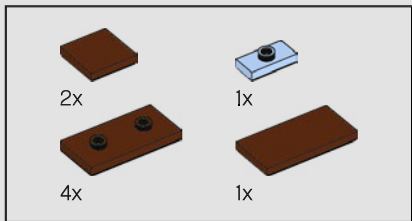
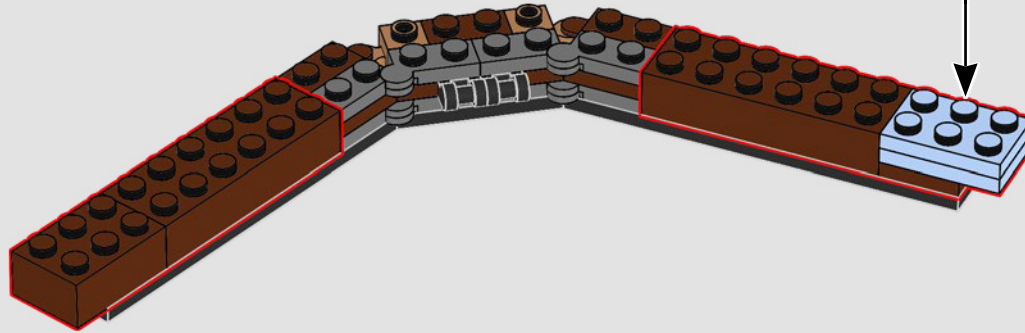
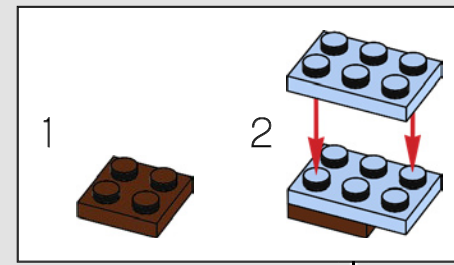

128

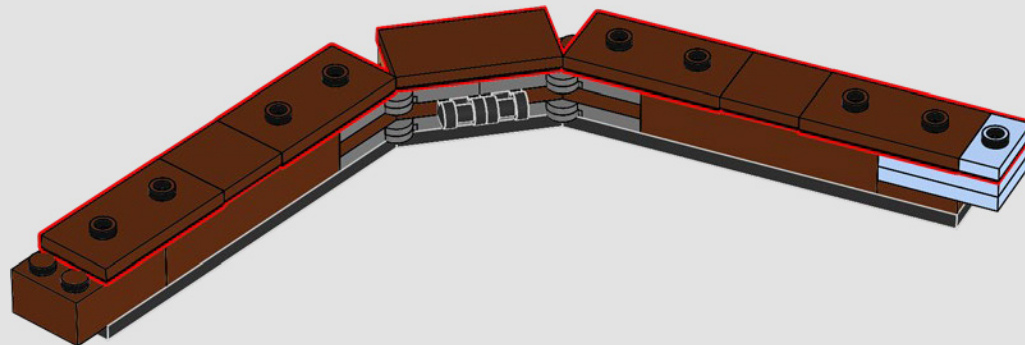

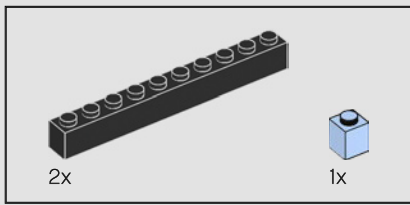

129

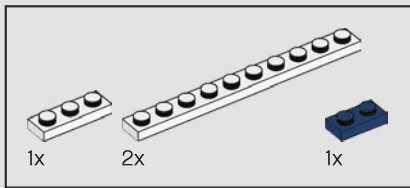
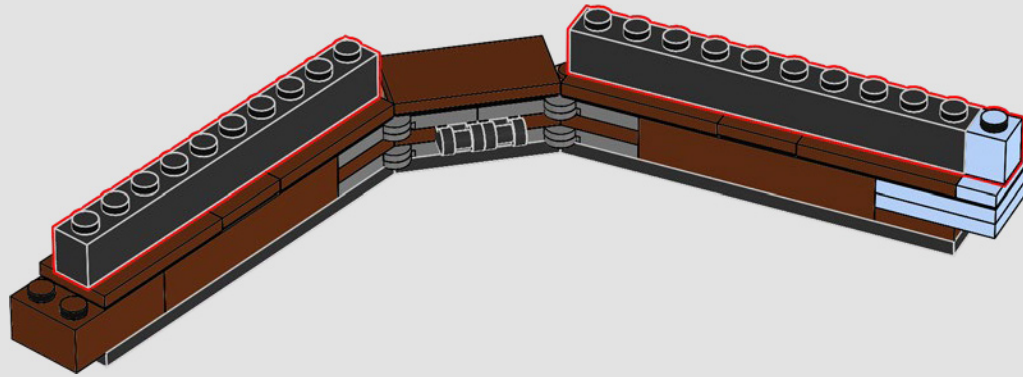

130

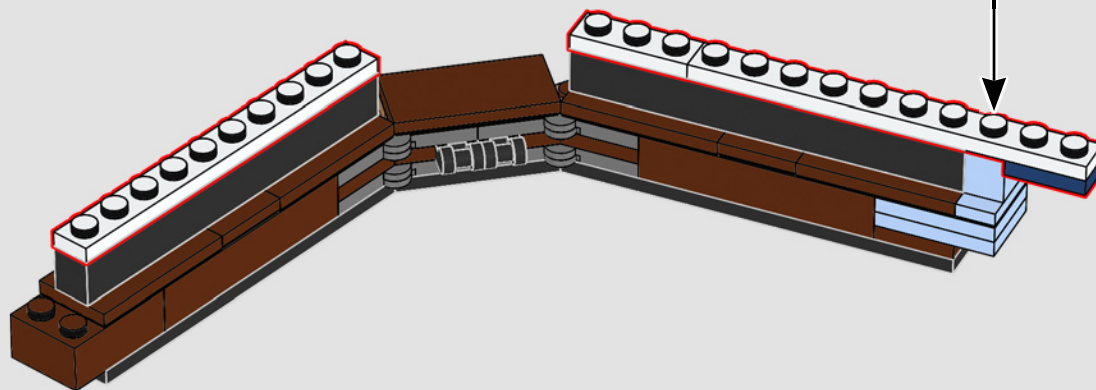
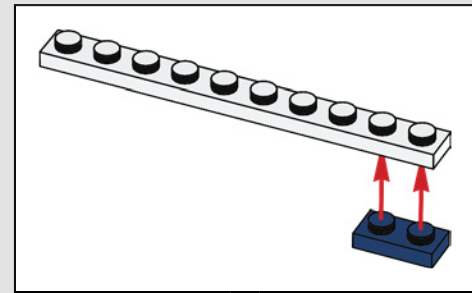



131

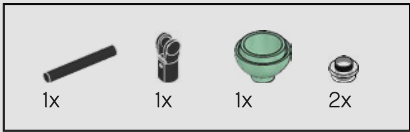
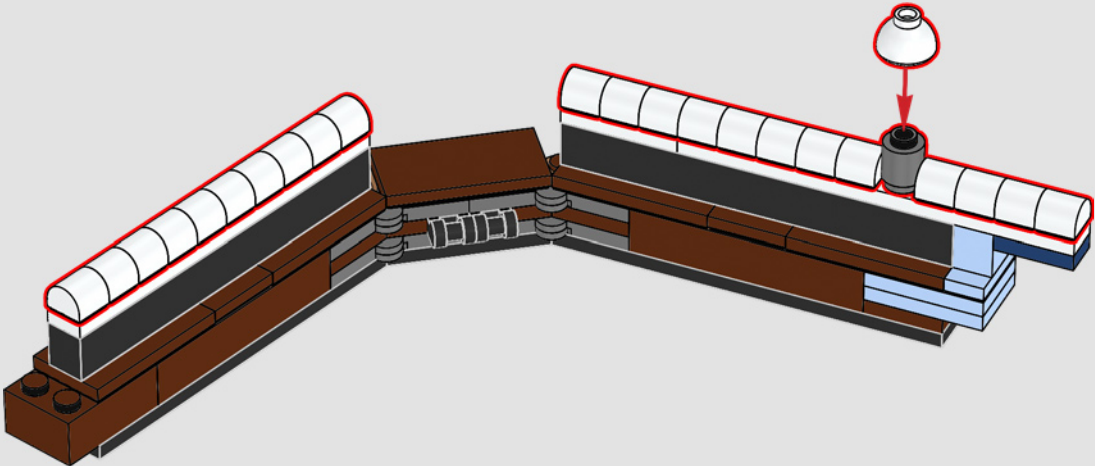

132

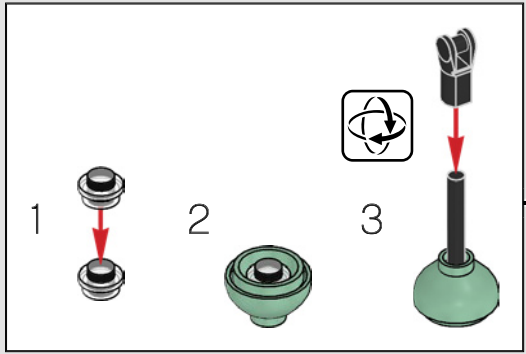
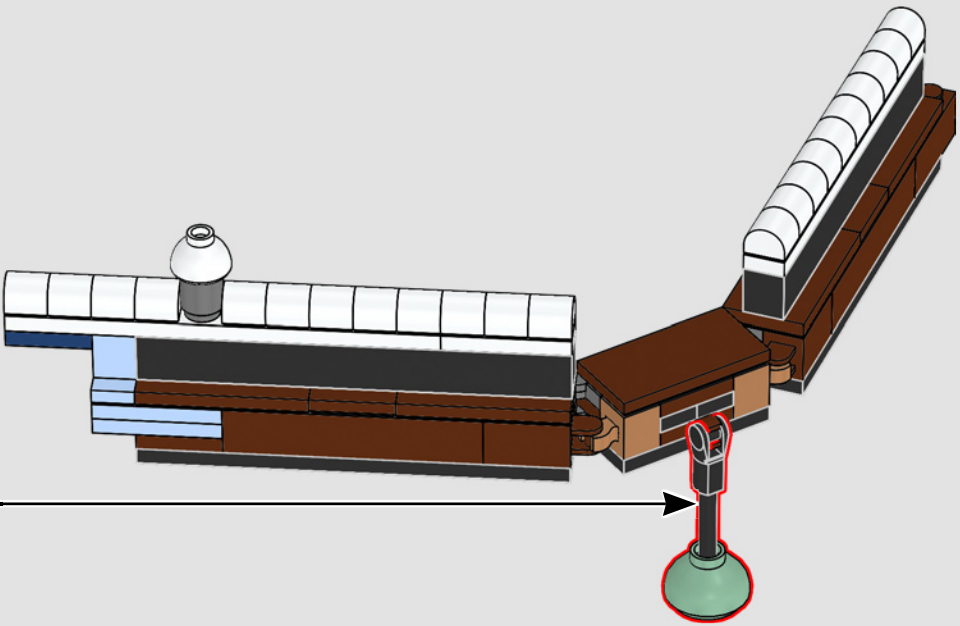



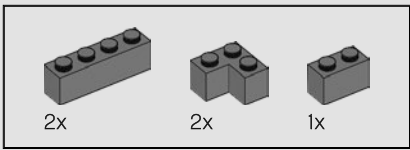

134



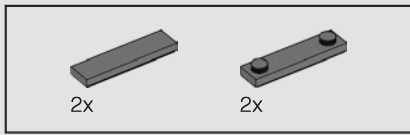

135



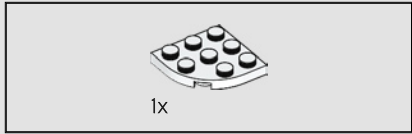

136

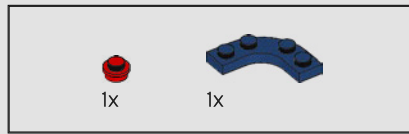

137

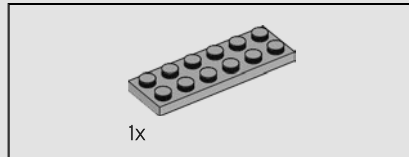
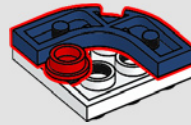

138

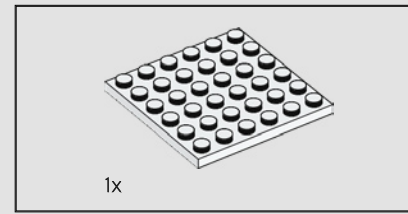
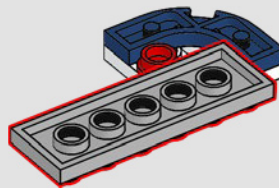

139

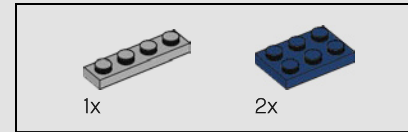
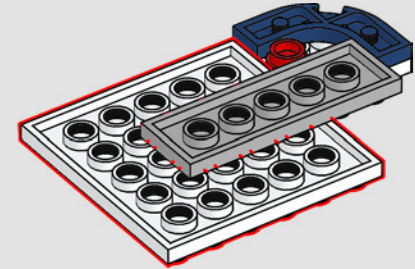

140

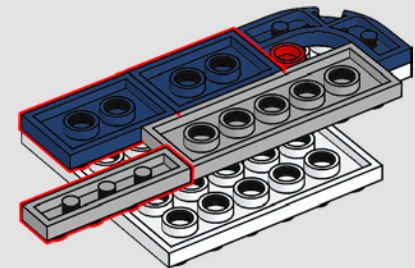

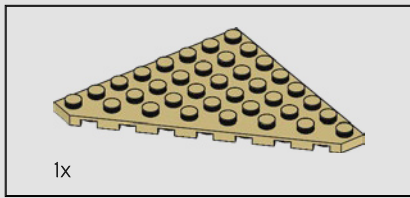

141

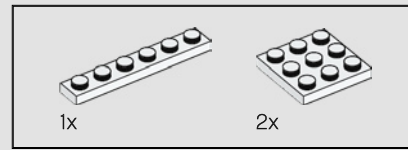
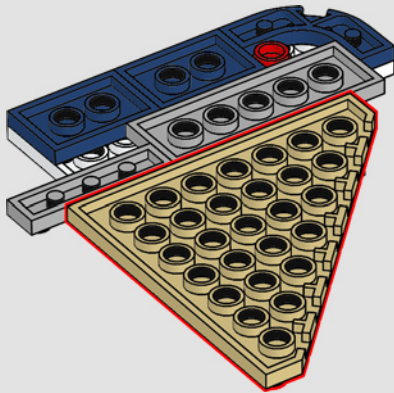

142

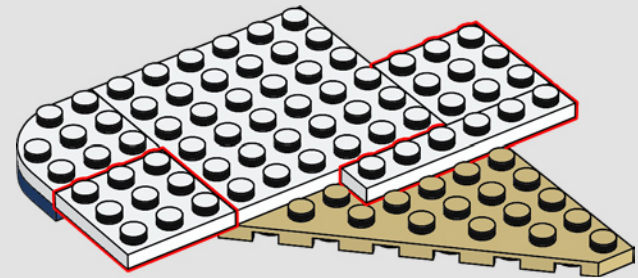
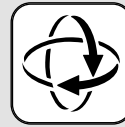

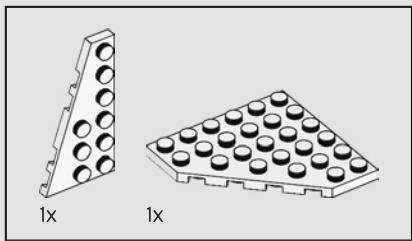

143

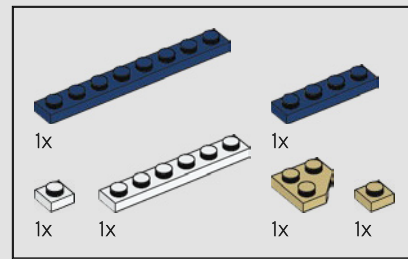
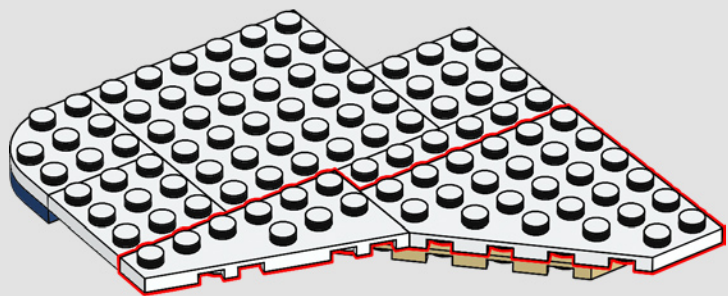

144

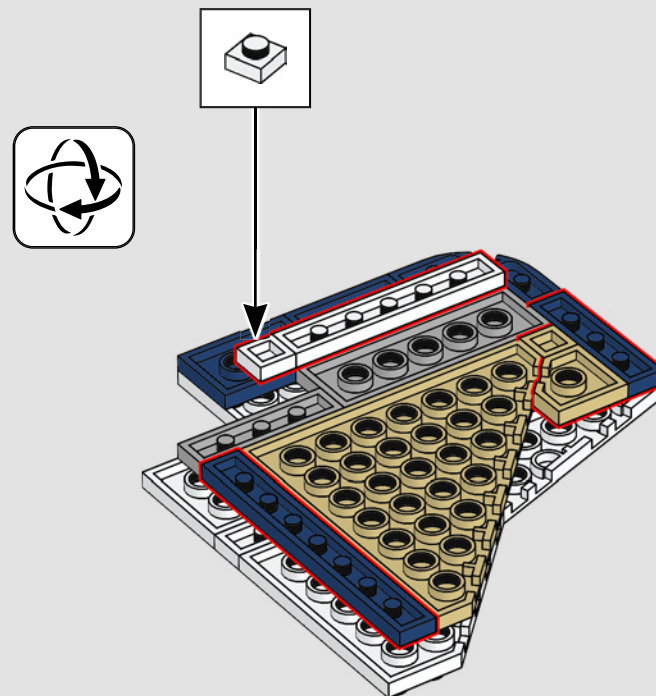

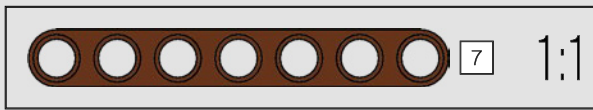
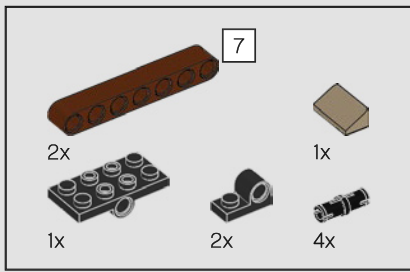

145

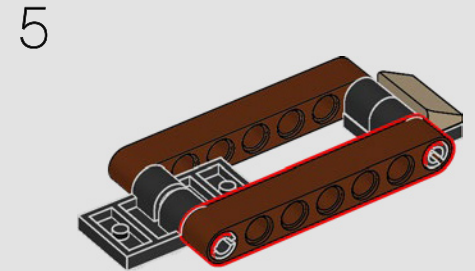
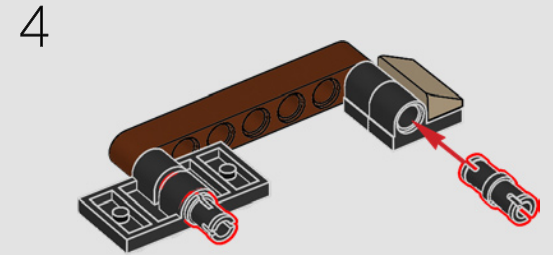
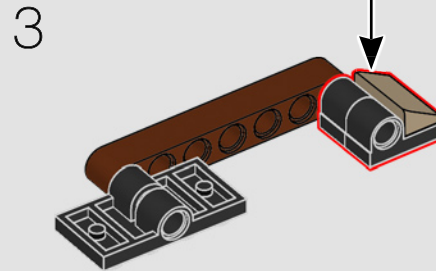
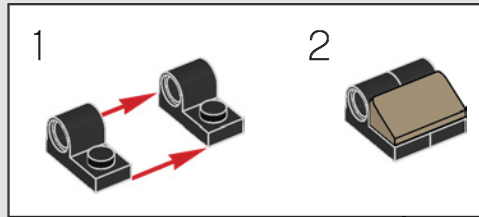
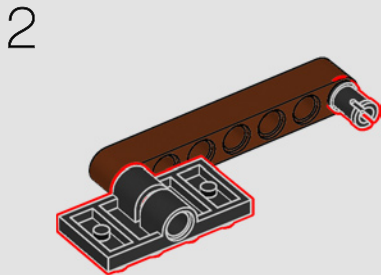
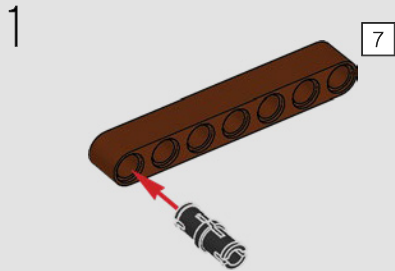

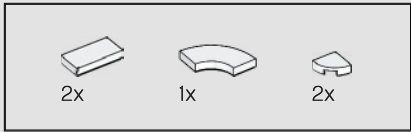
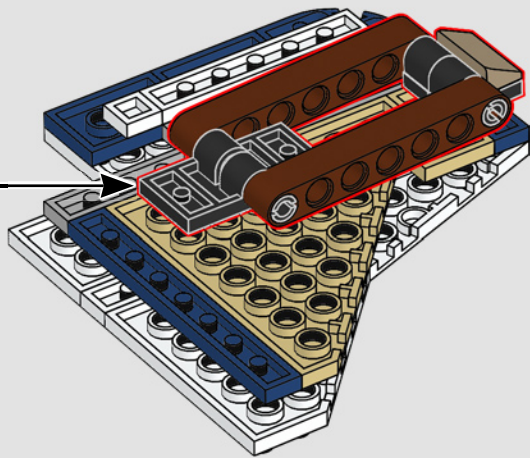

146

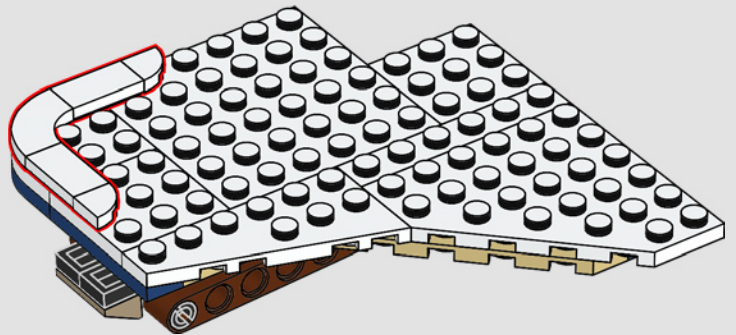

147

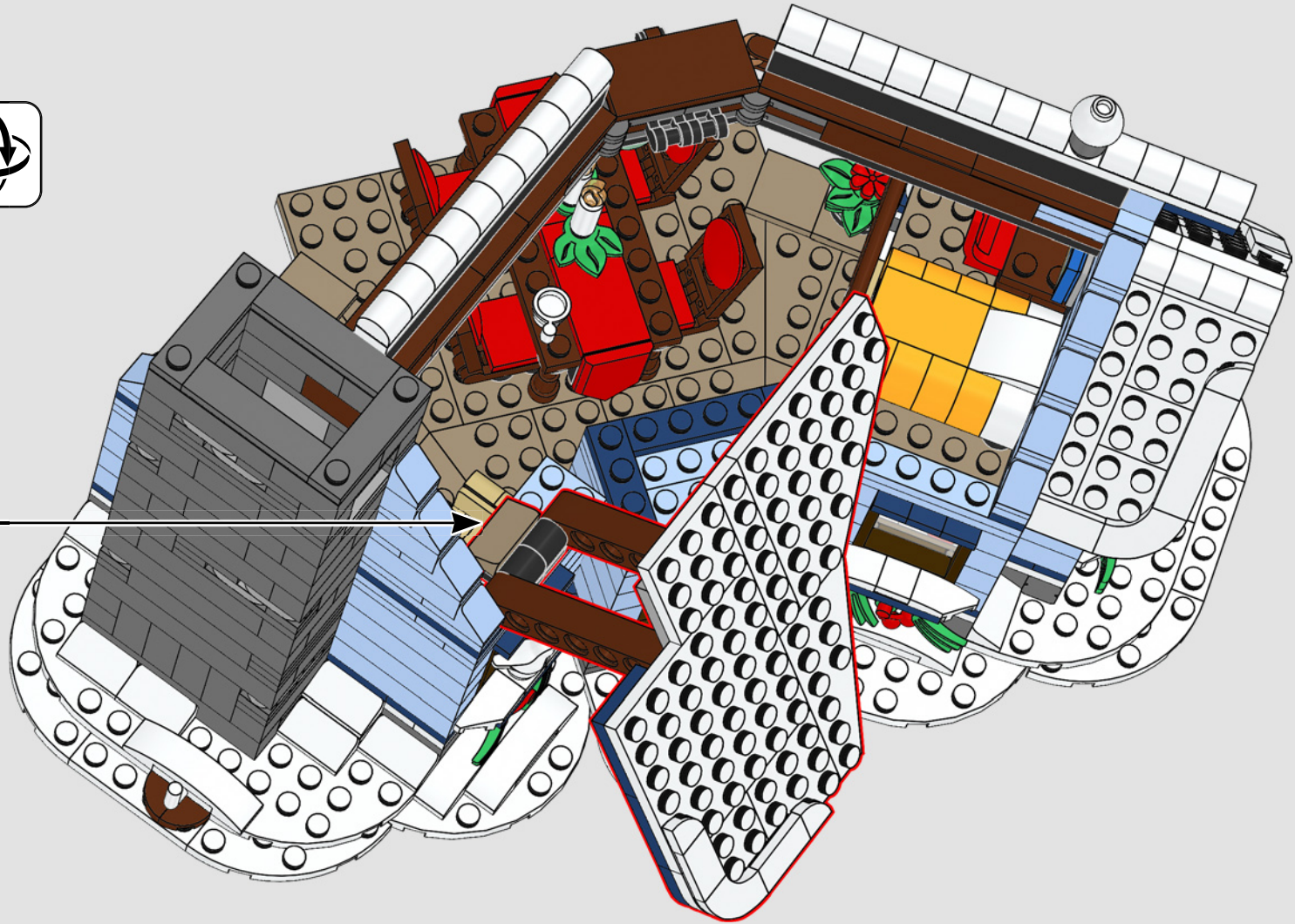



148

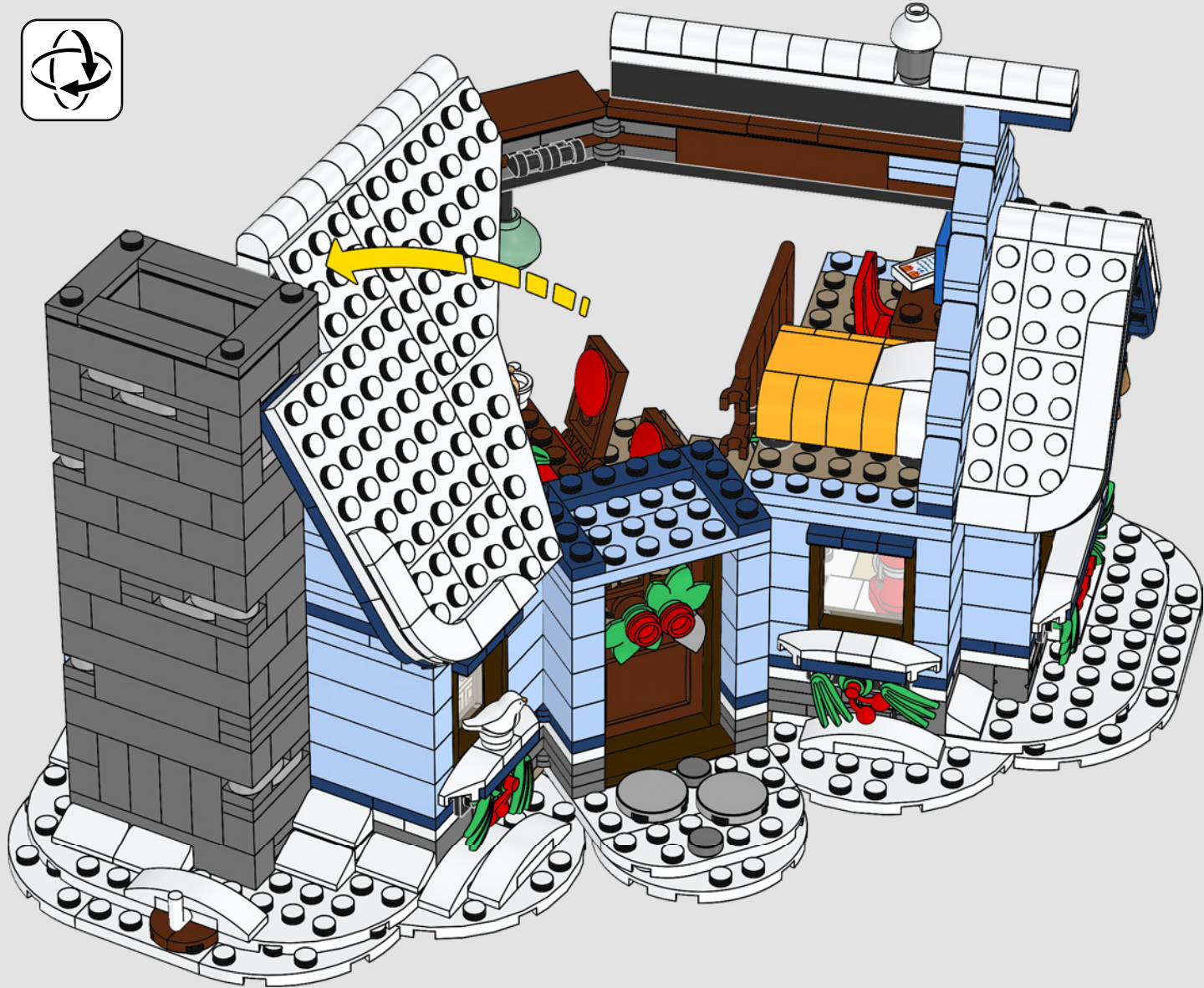

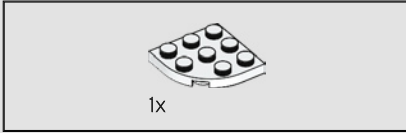
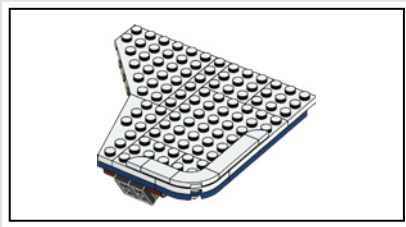

149

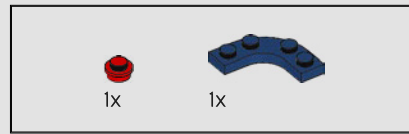

150

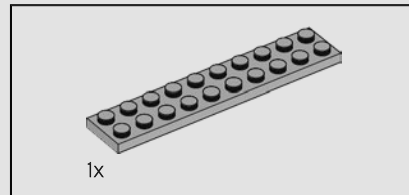

151

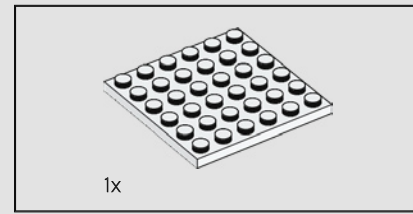
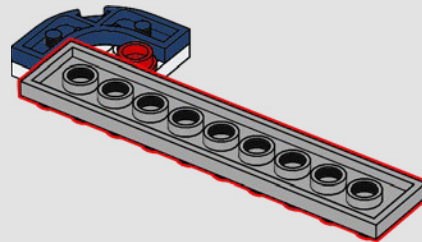

152

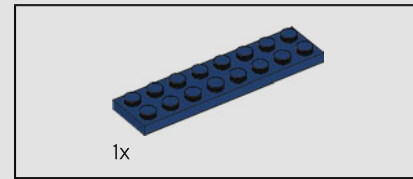
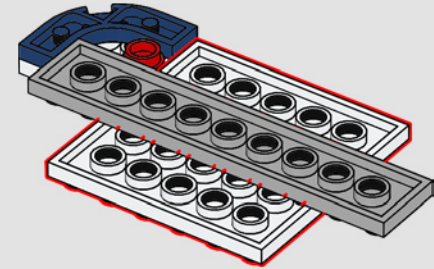

153

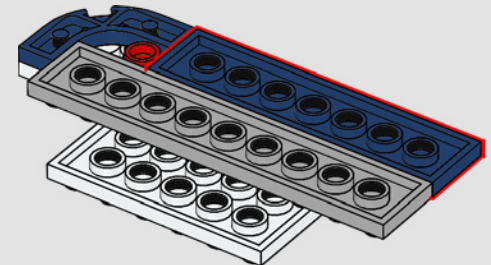

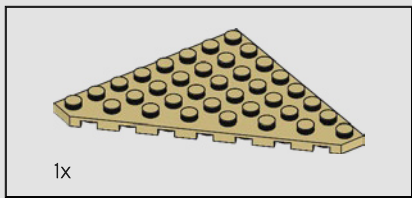

154

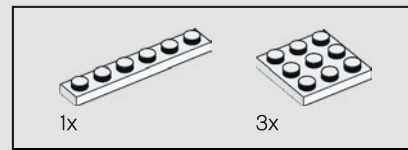
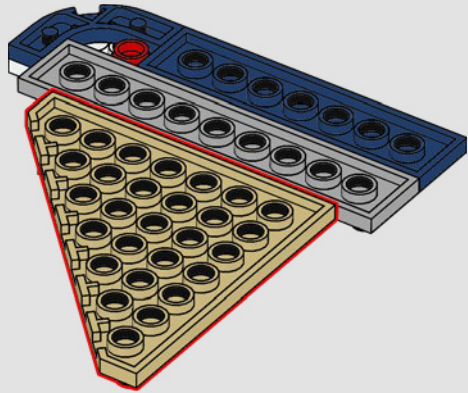

155

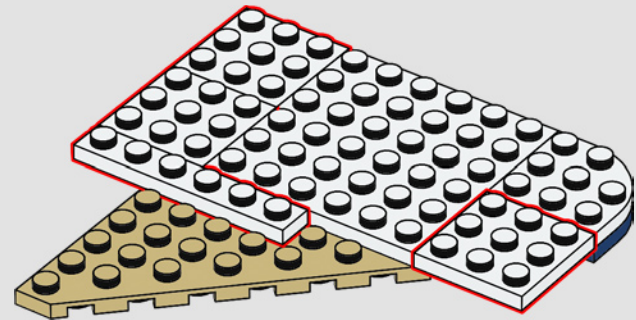
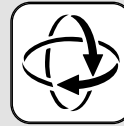

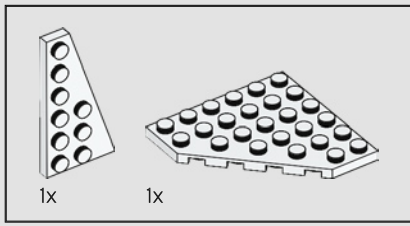

156

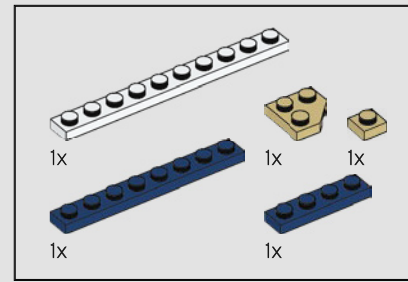
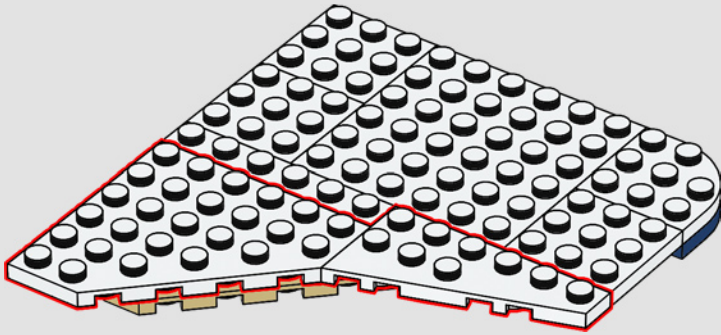

157

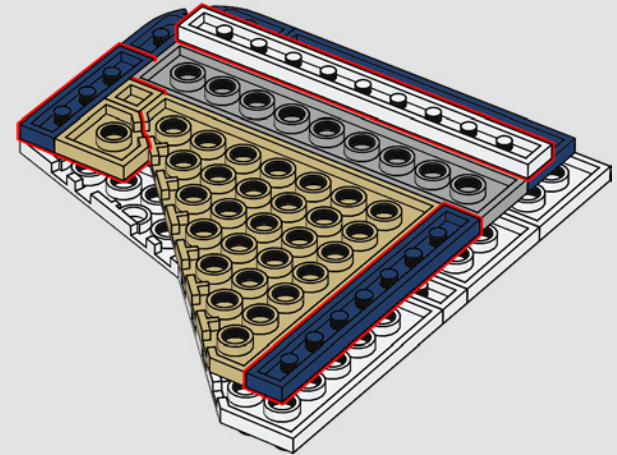
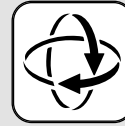

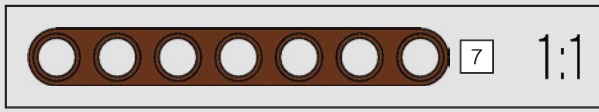
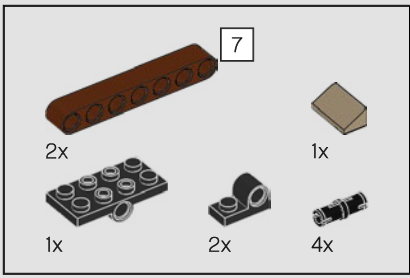

158

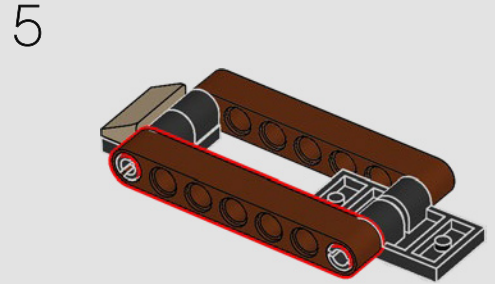
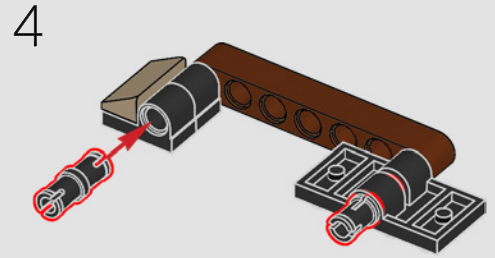
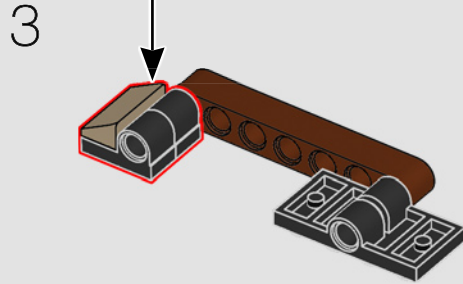
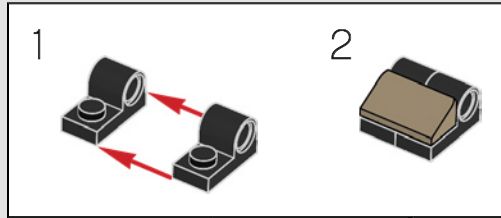
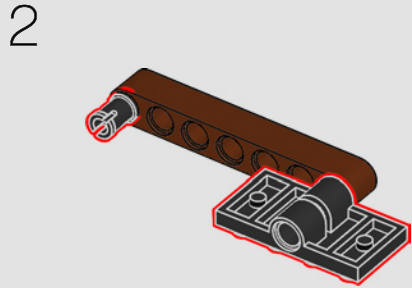
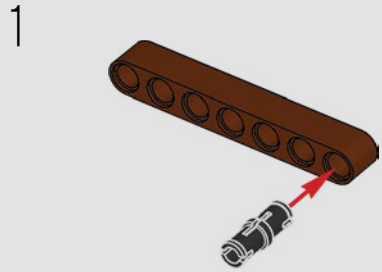

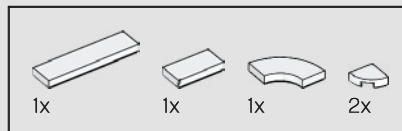
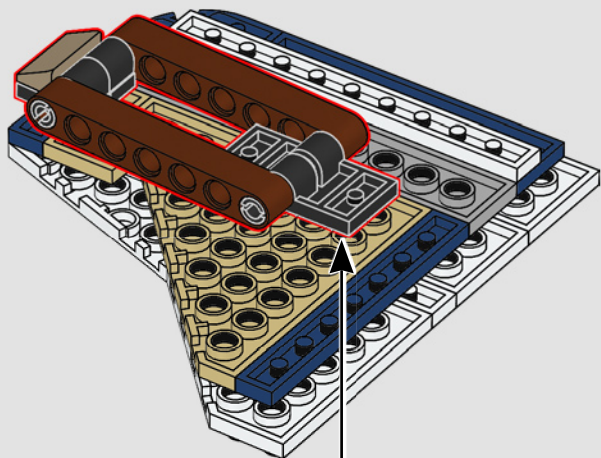

159

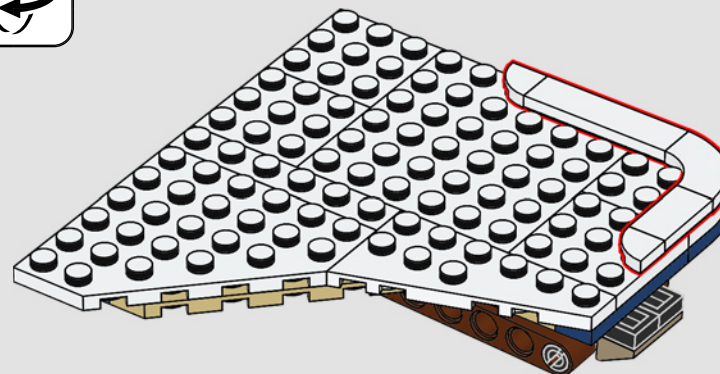

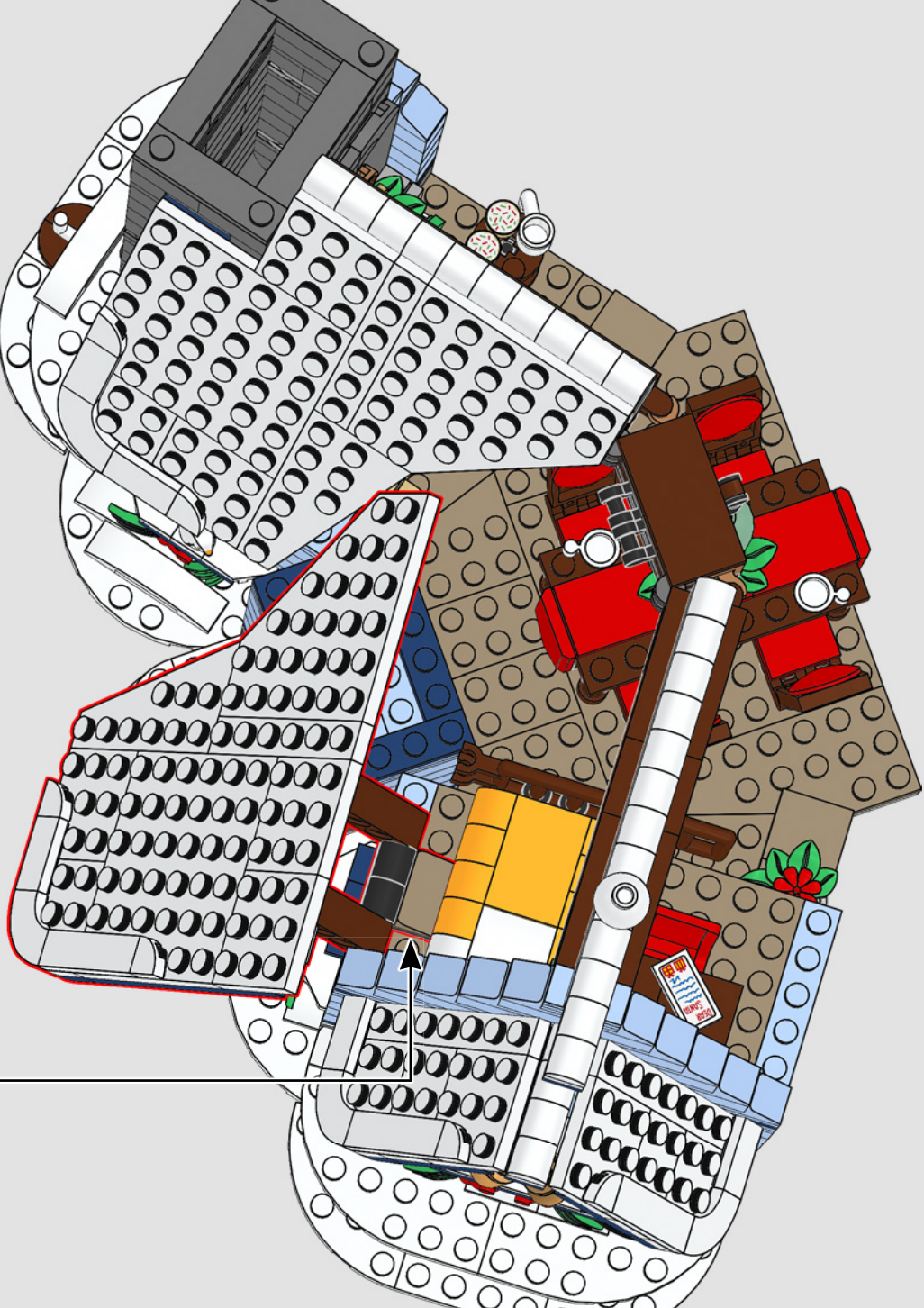

161

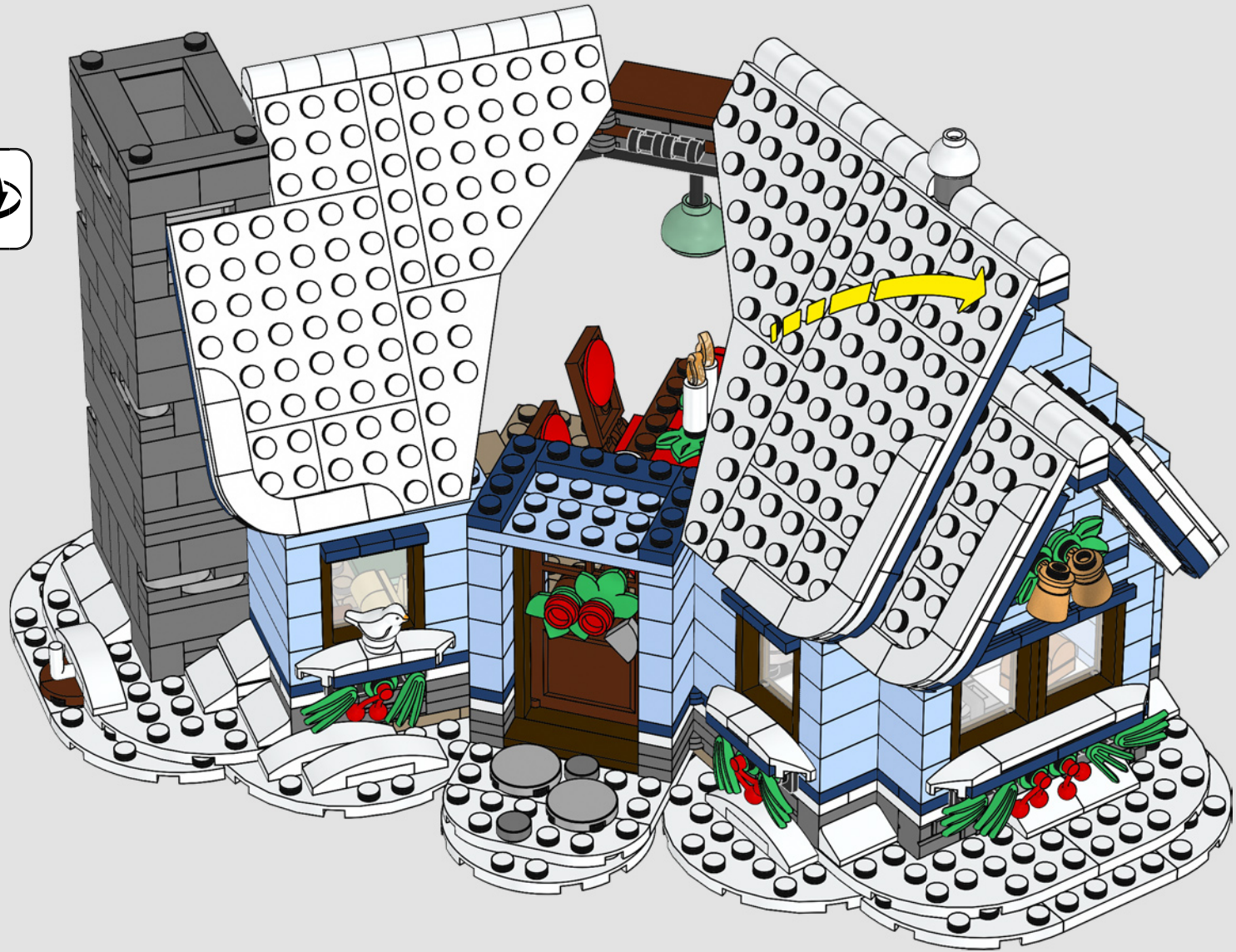

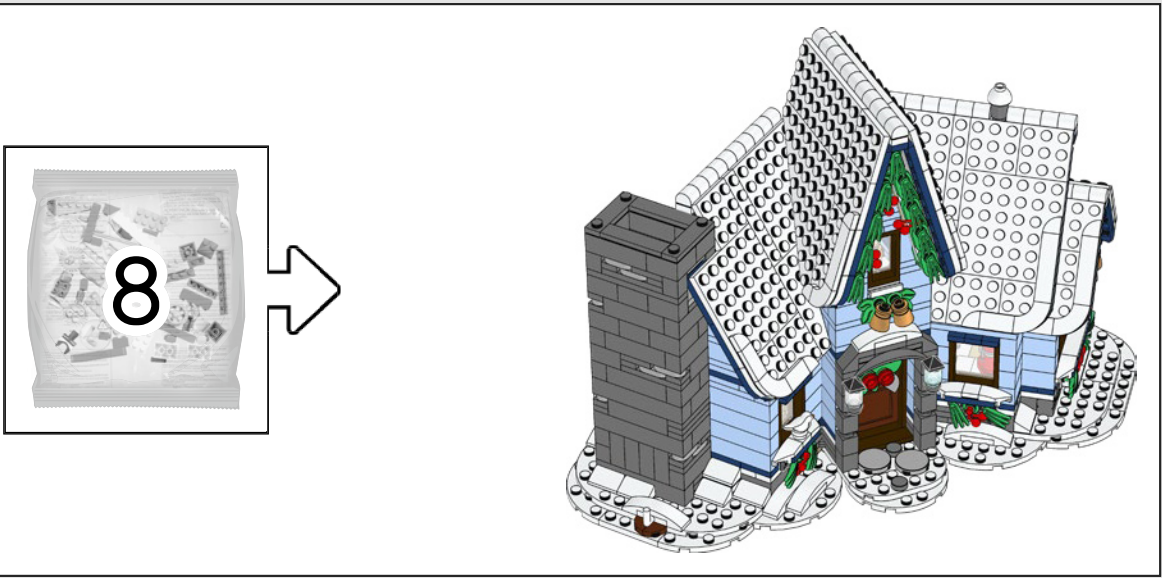



162

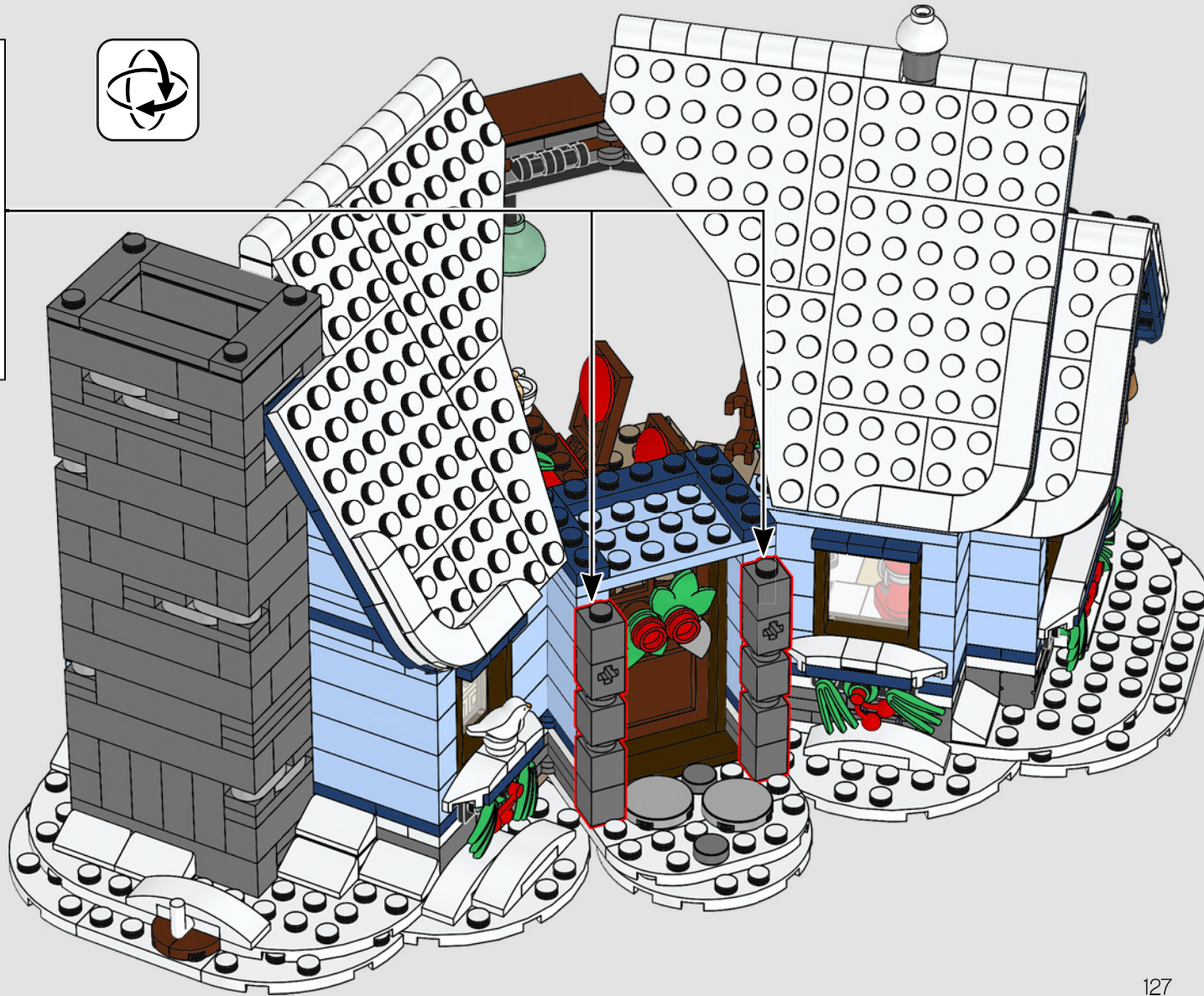
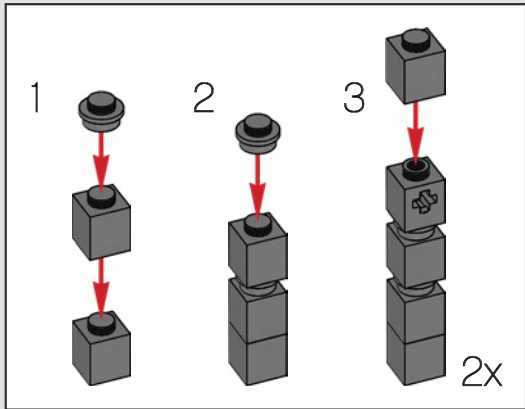

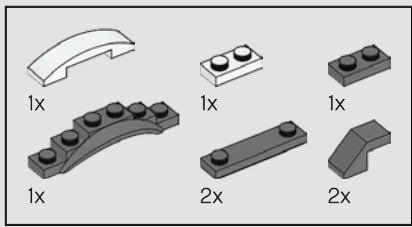

163

1

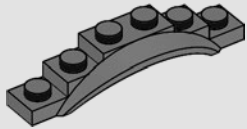

2

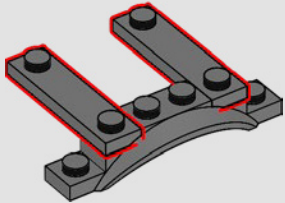

3

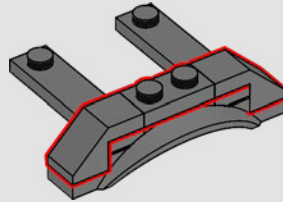

4

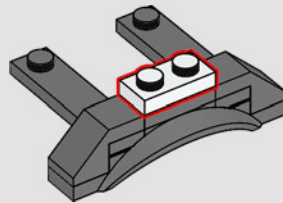

5

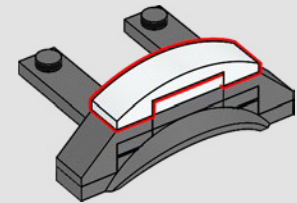

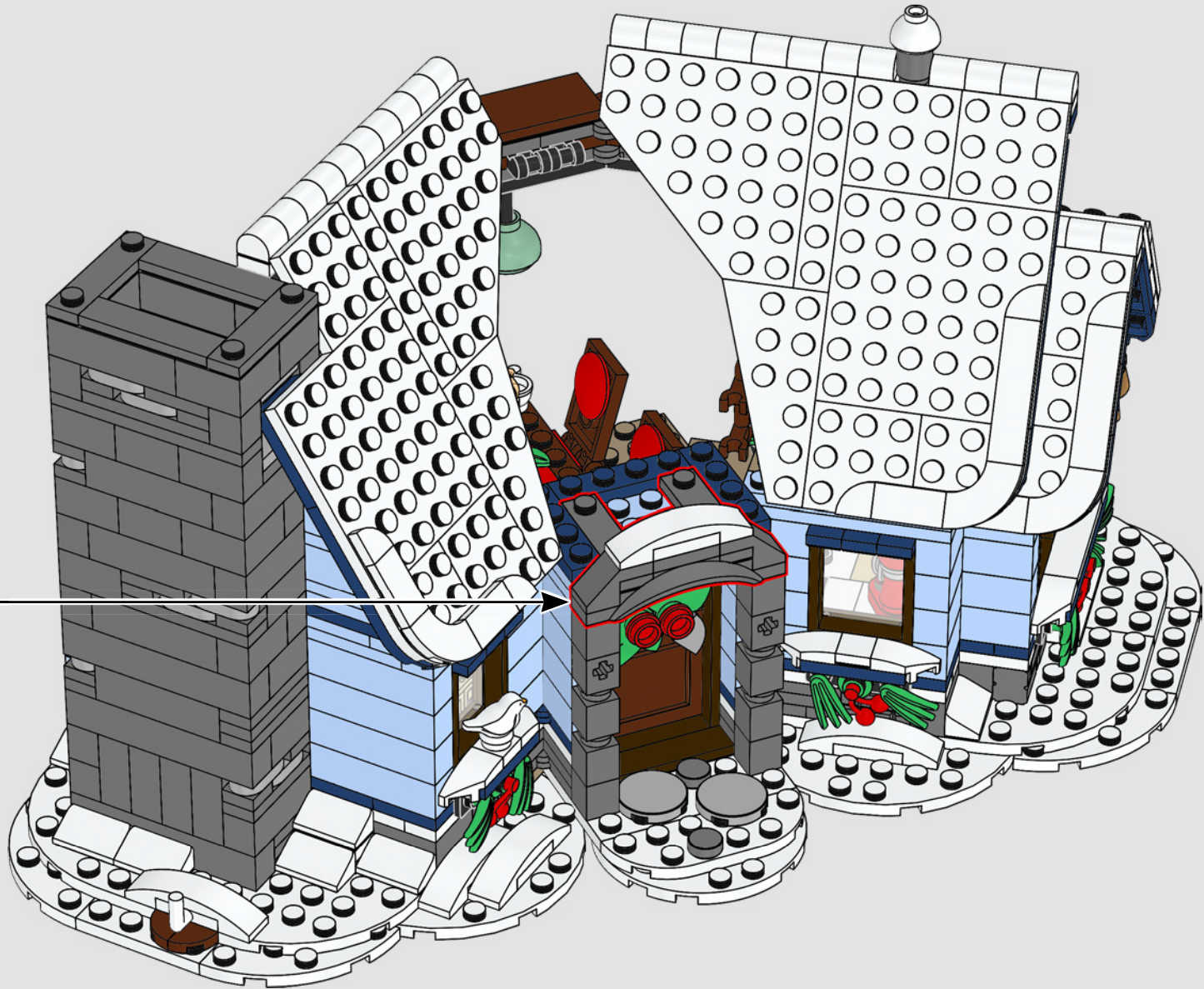

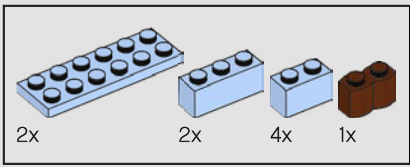

164

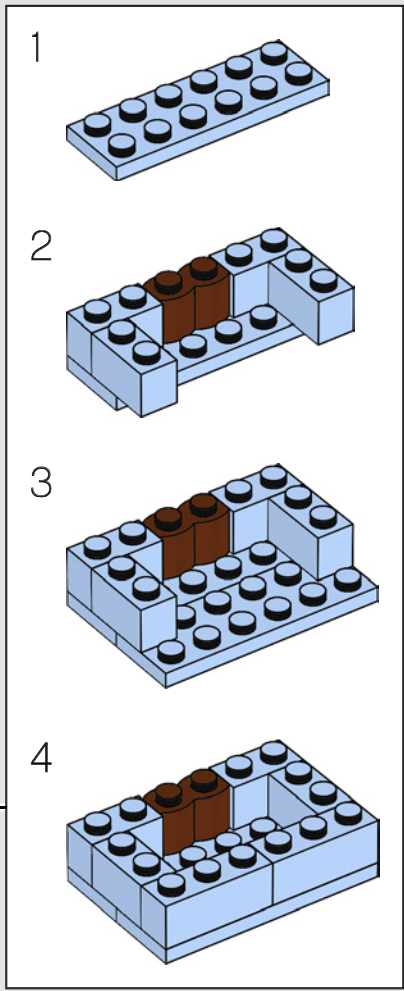
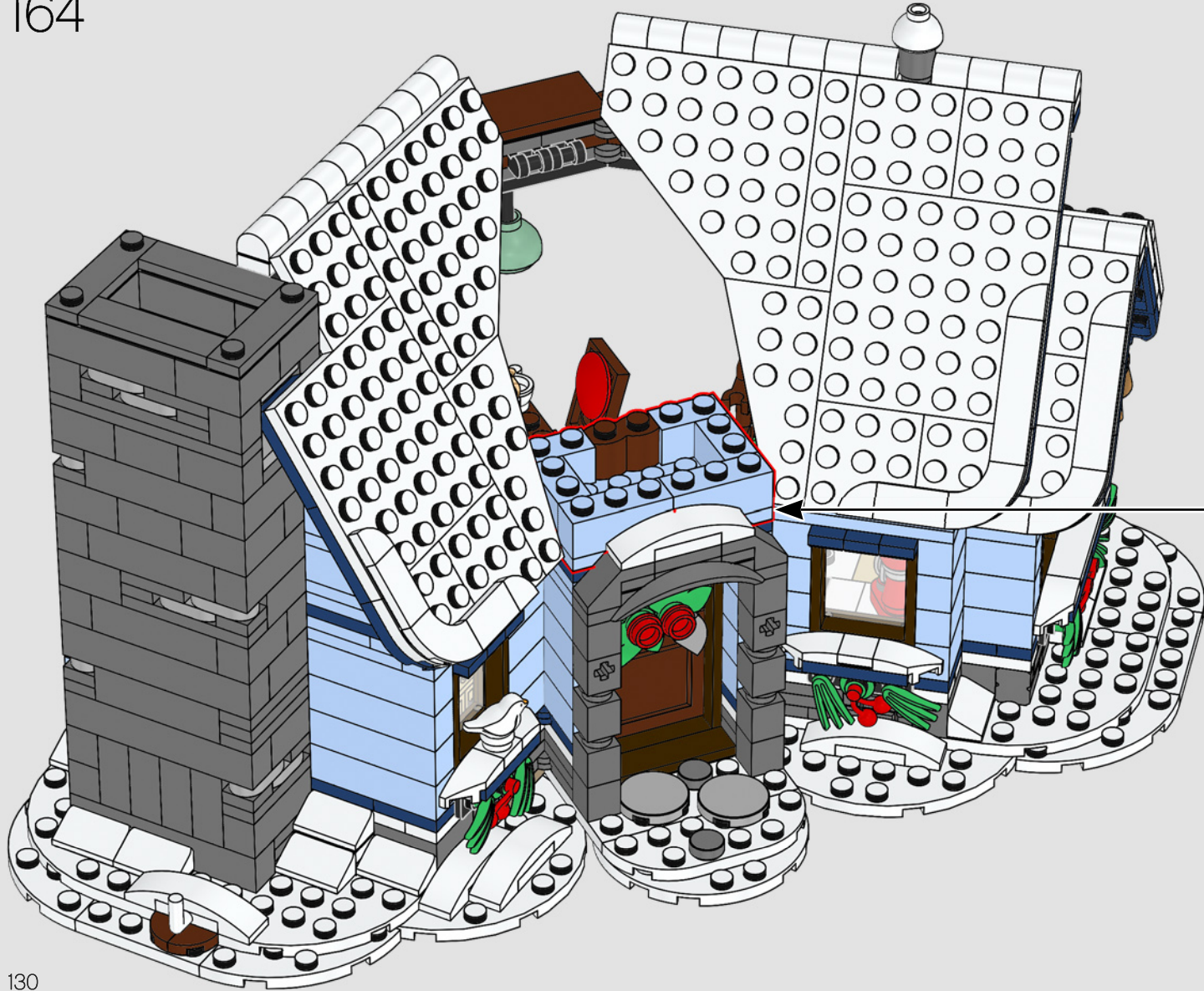

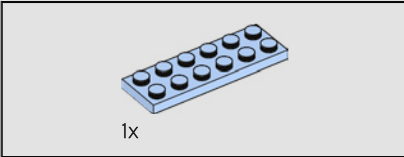
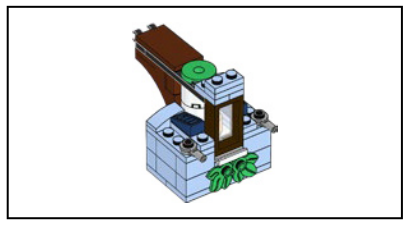

1x

165

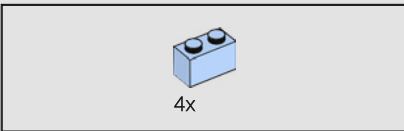
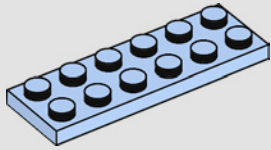

4x

166

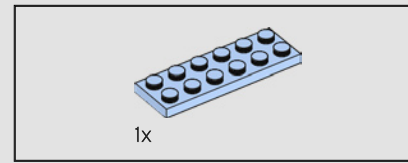
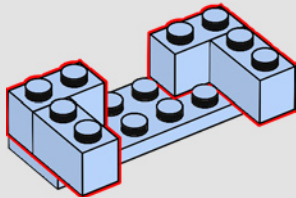

1x

167

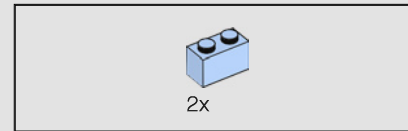
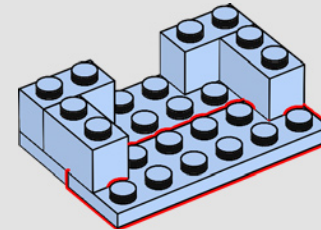

2x

168

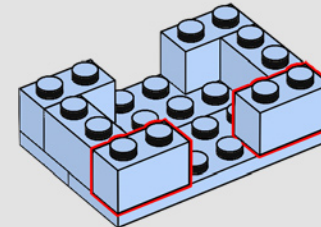

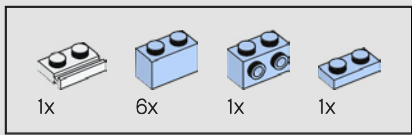

169

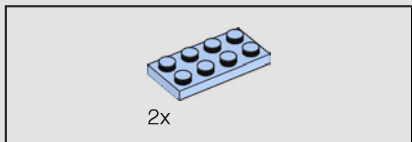
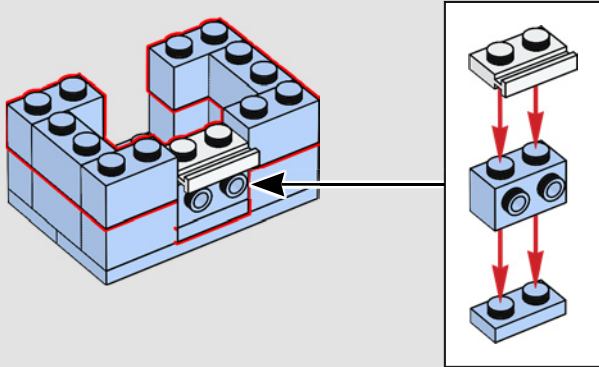

170

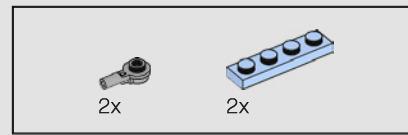
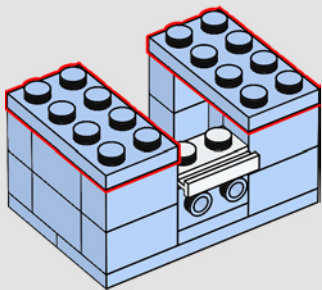

171

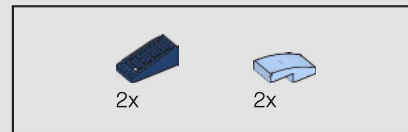
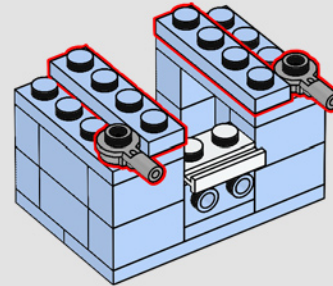

172

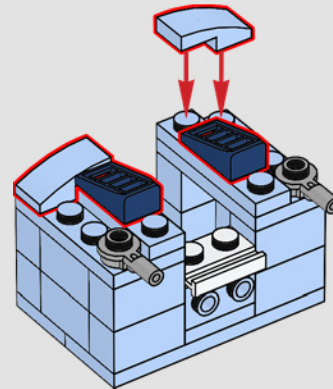

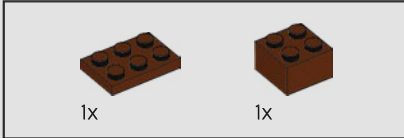
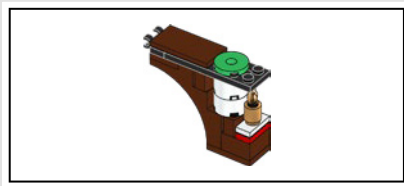

173

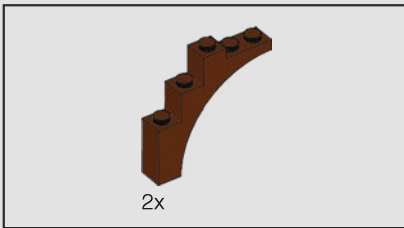
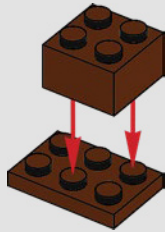

174

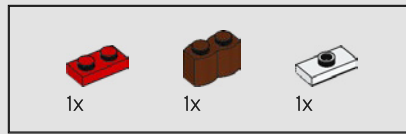
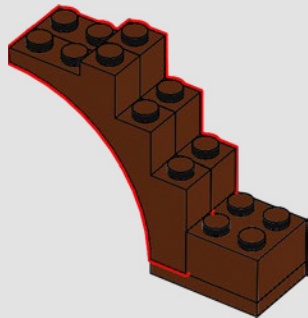

175

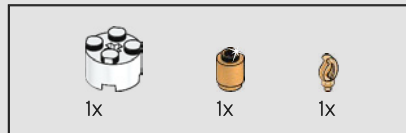
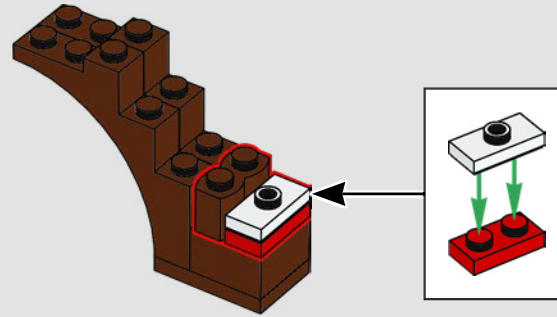

176

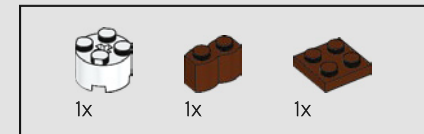
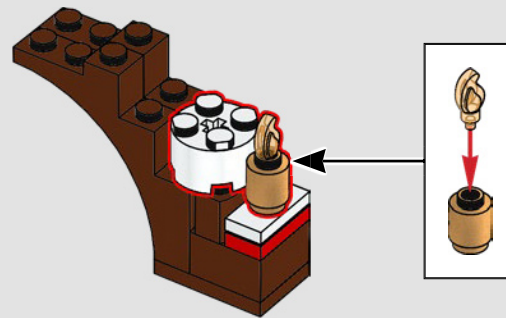

177

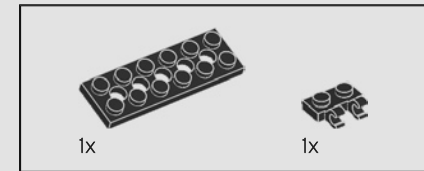
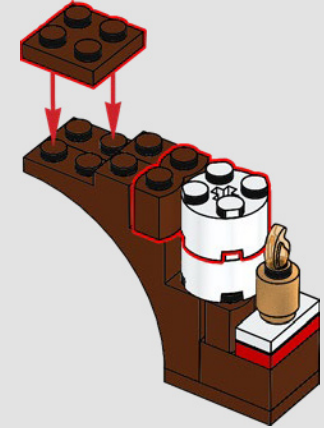

178

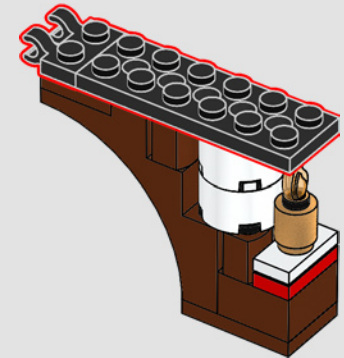



179



180

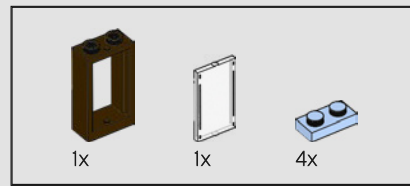
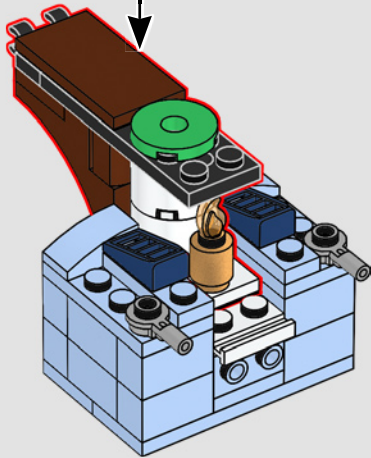

181

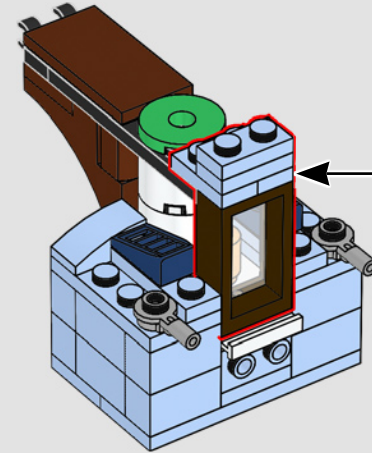
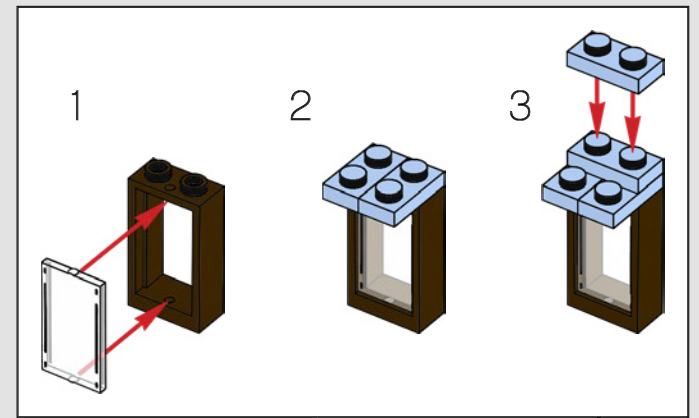



2x

182

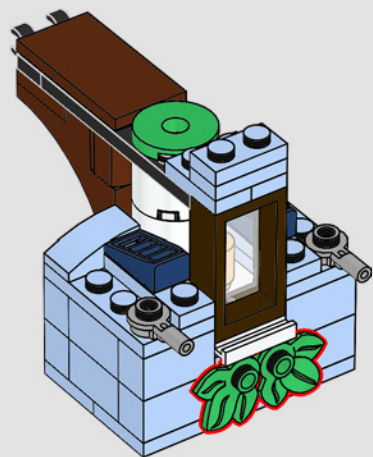

183

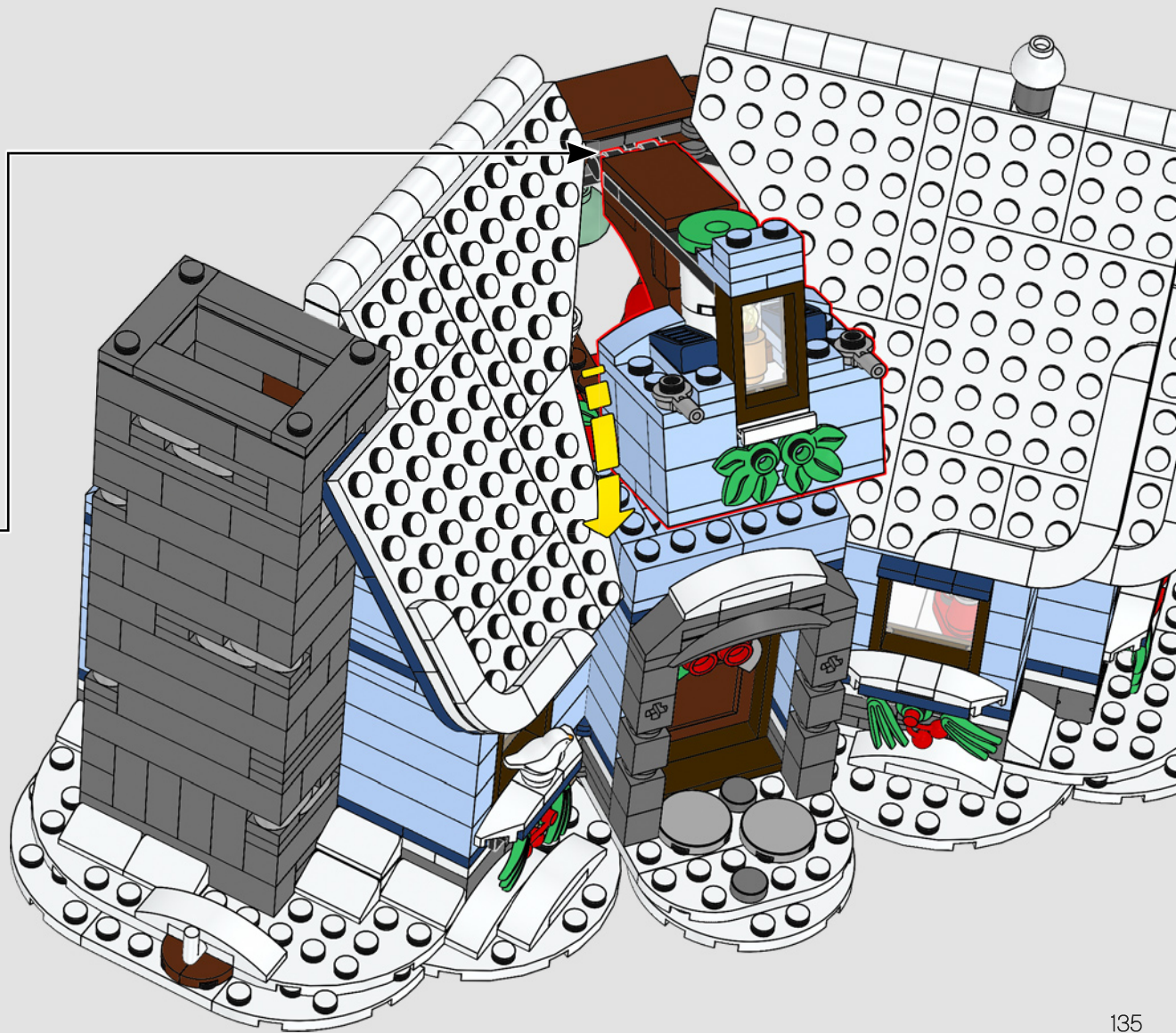

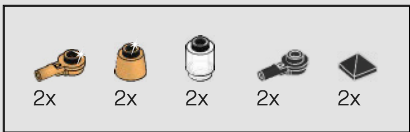

184

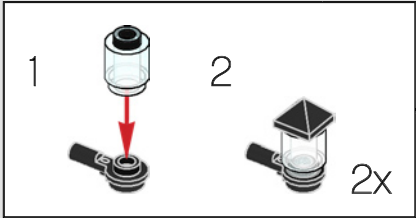
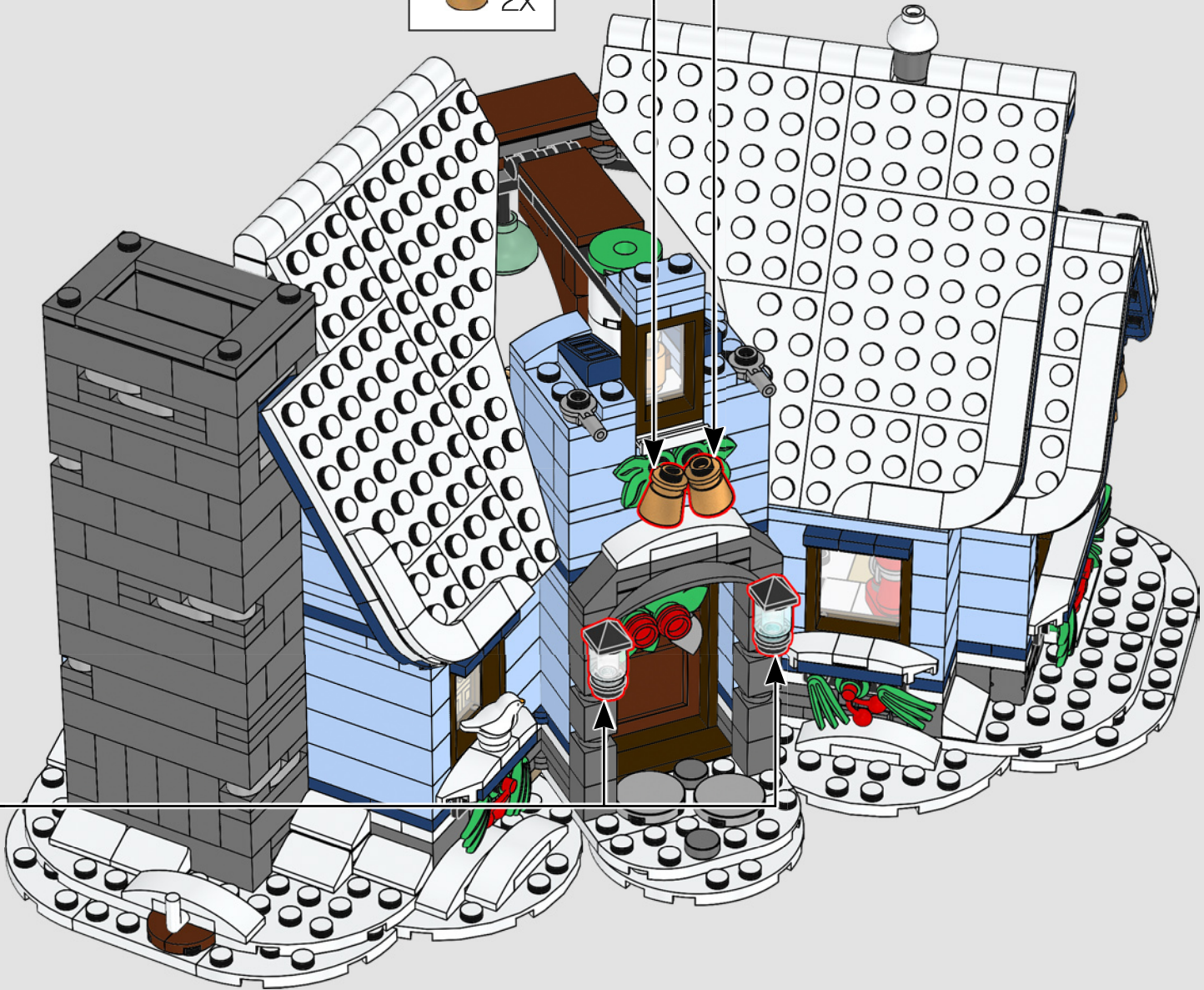
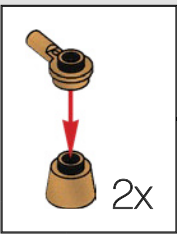

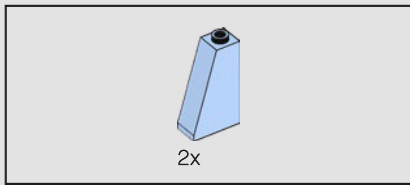

185

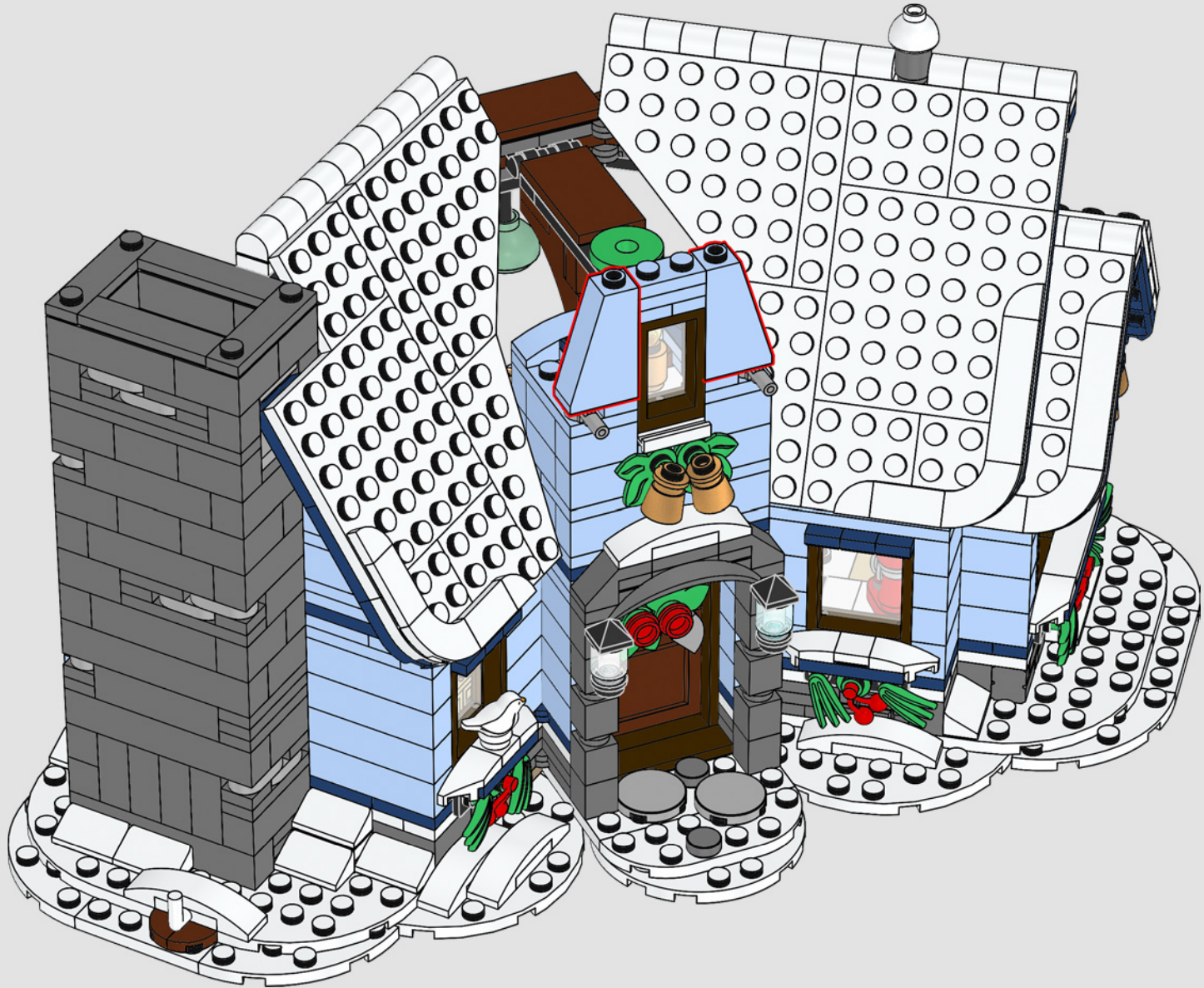

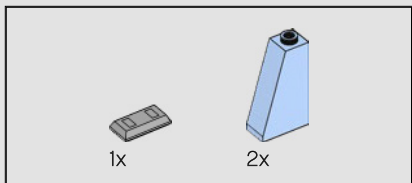

186

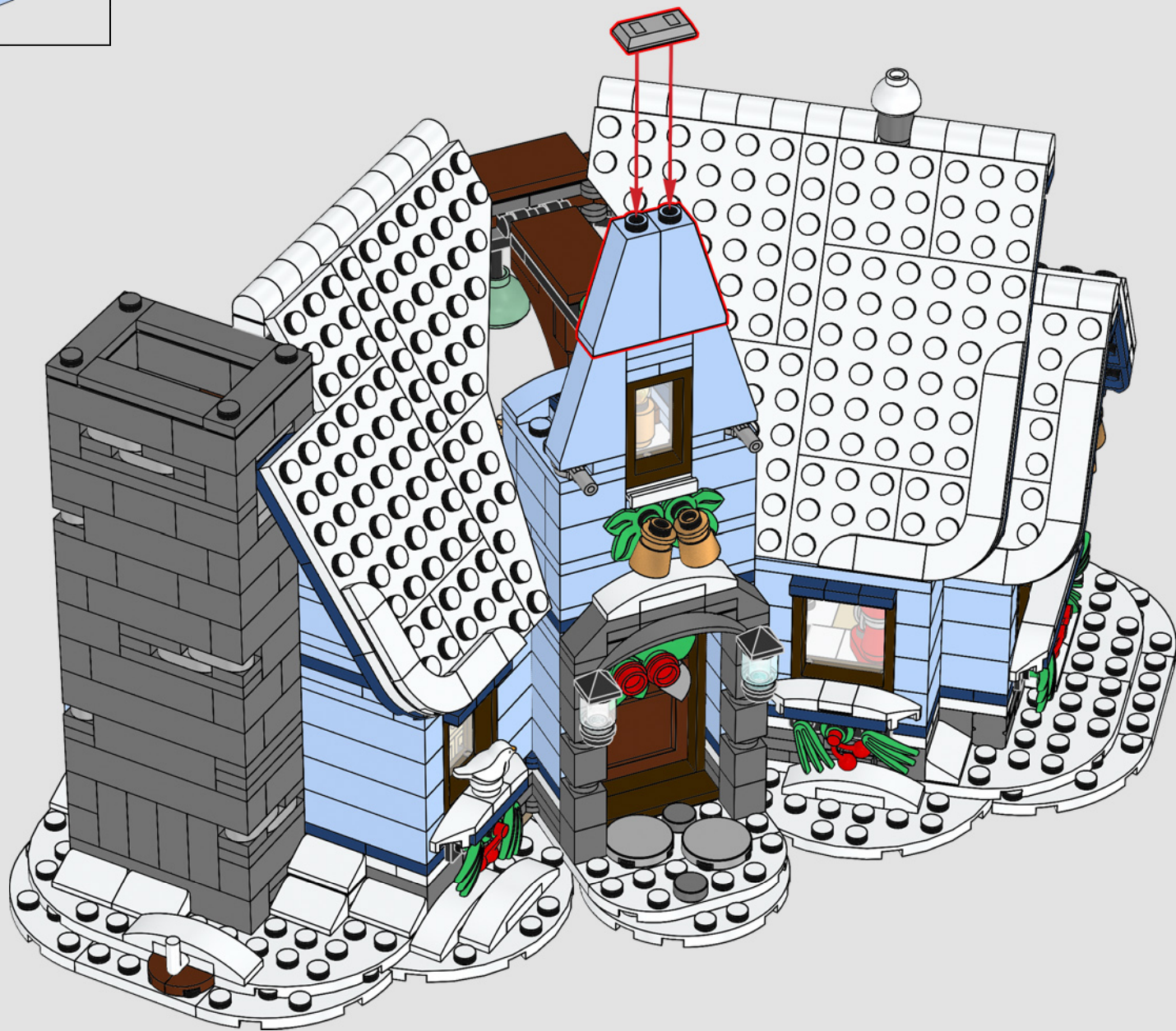

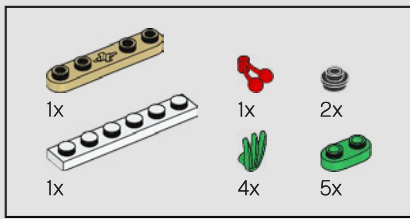

187

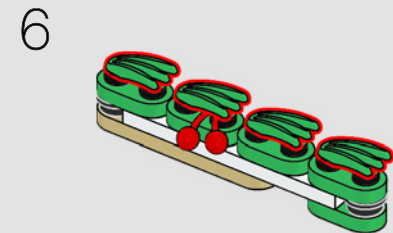
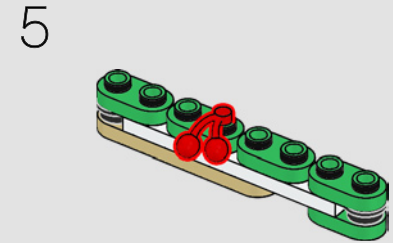
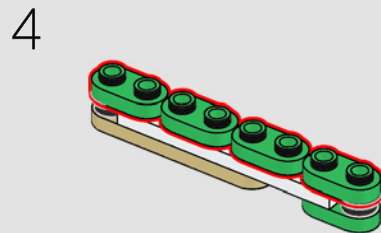
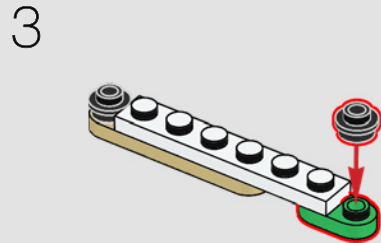
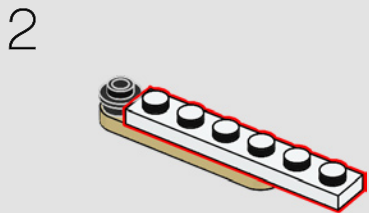
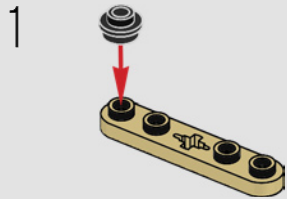

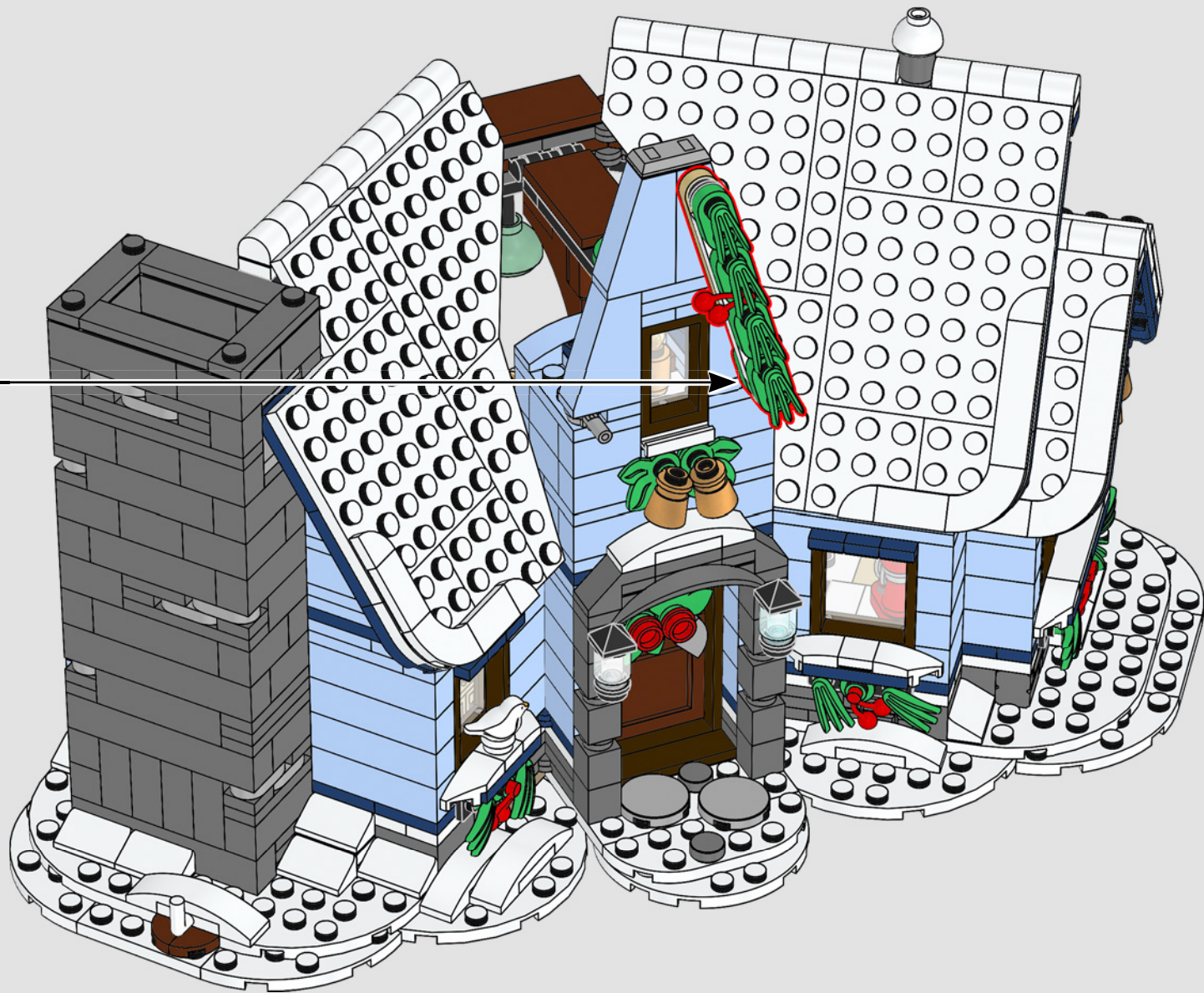

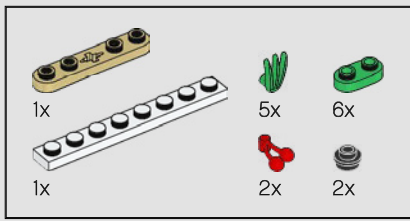

188

1

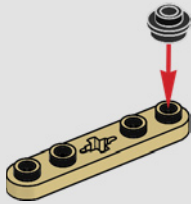

2

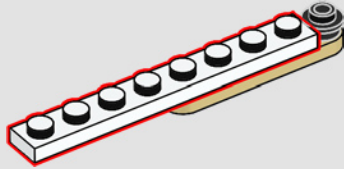

3

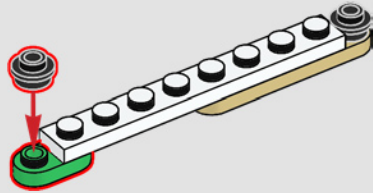

4

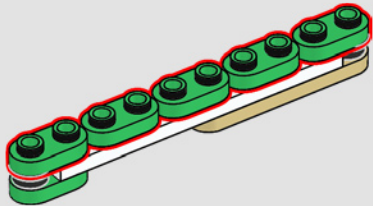

5

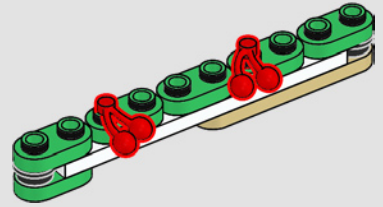

6

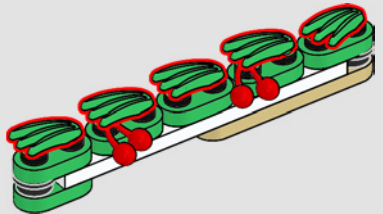



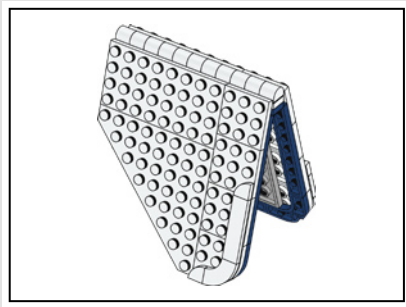

189

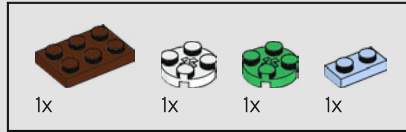
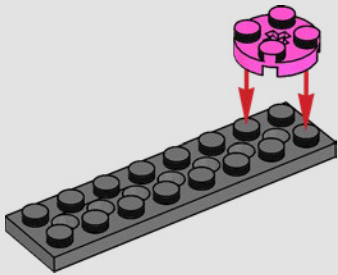

190

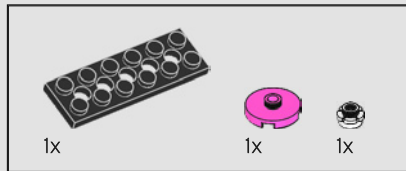
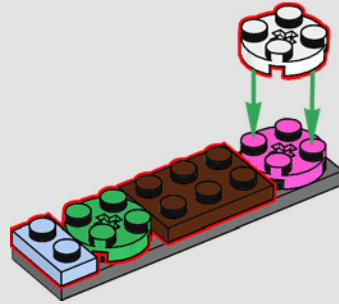

191

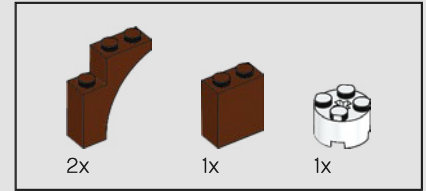
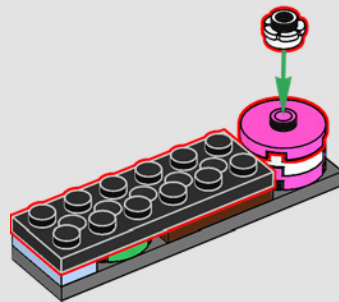

192

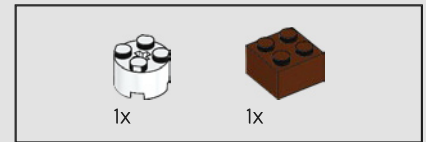
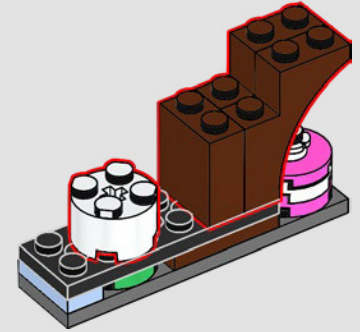

193

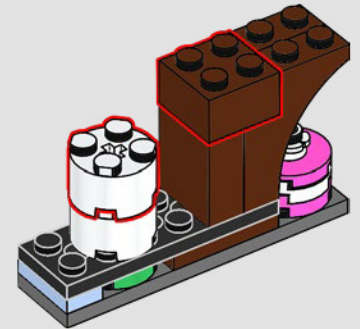

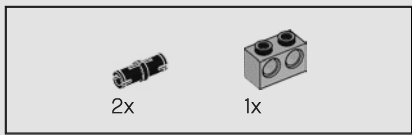

194

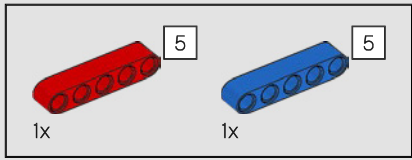
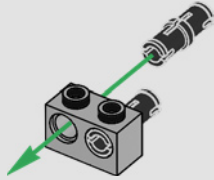
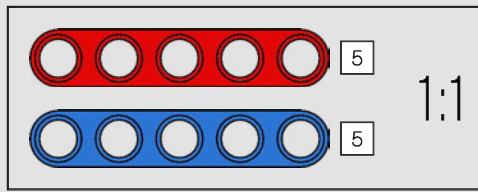

195

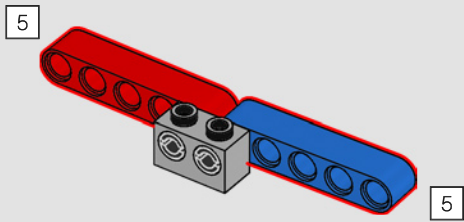

196

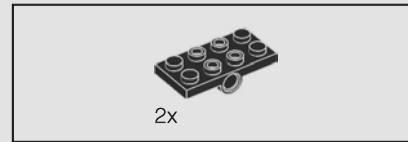
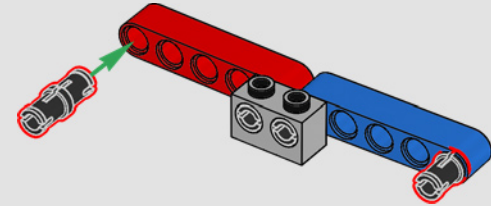

197

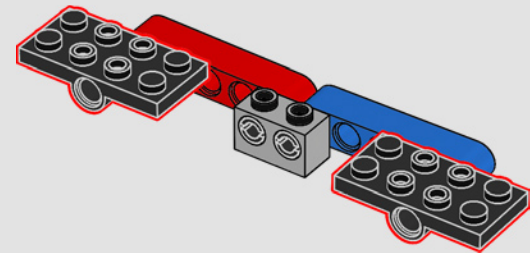



198

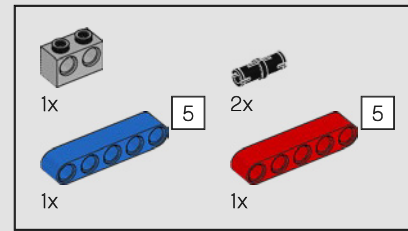
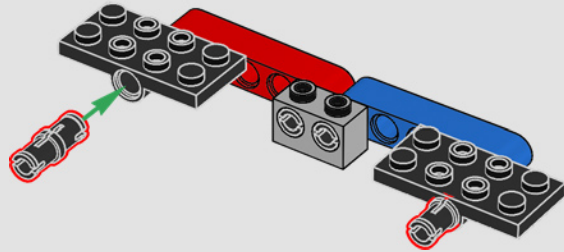

199

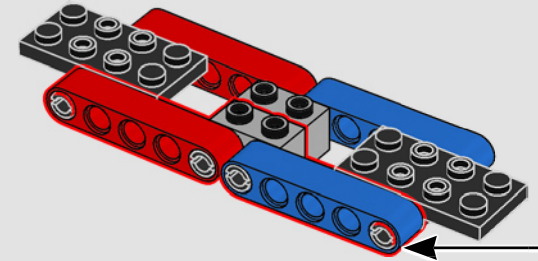
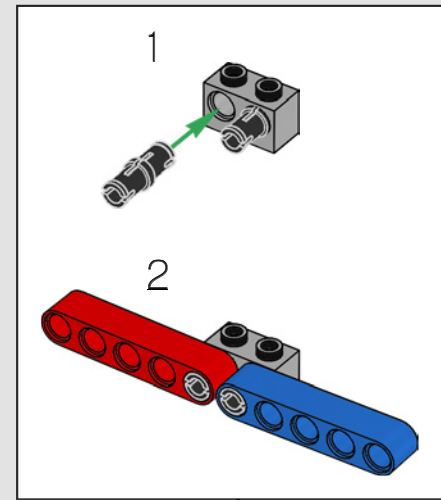

200

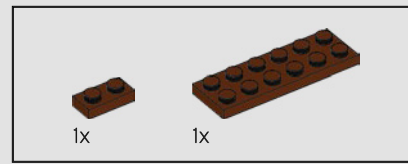
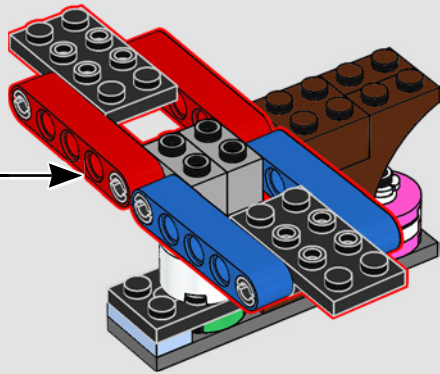

201

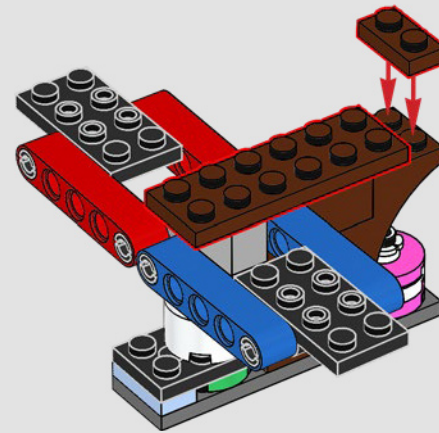



202

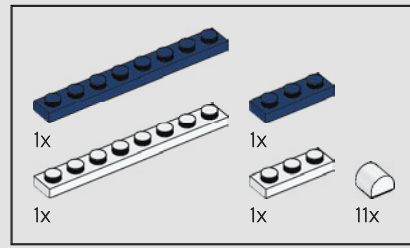
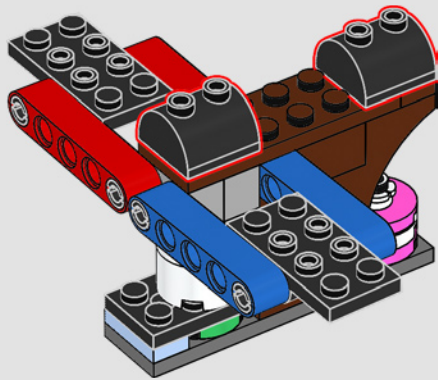

203

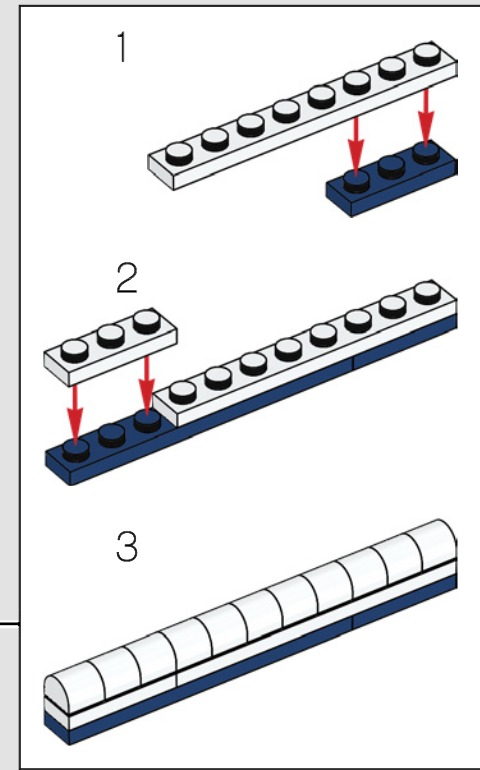
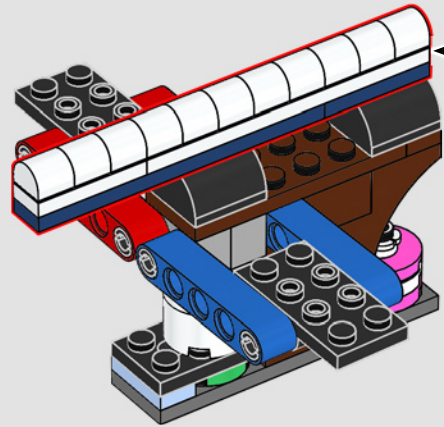

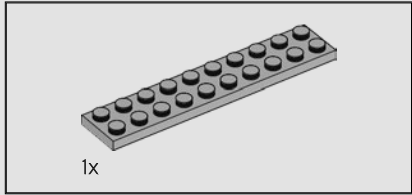
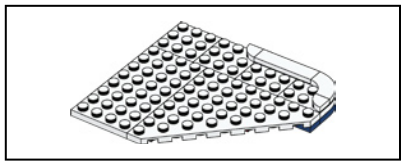

1x

204

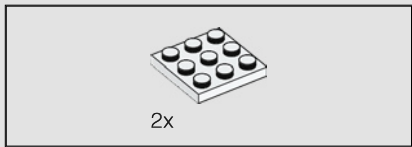
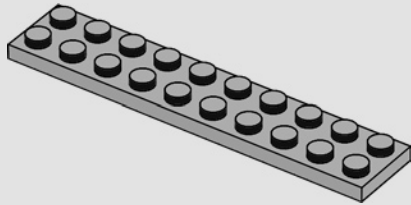

2x

205

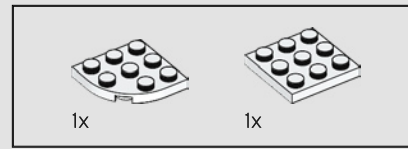
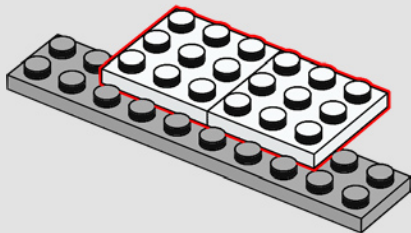

1x

1x

206

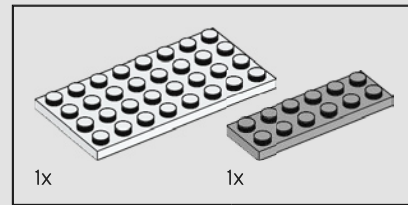
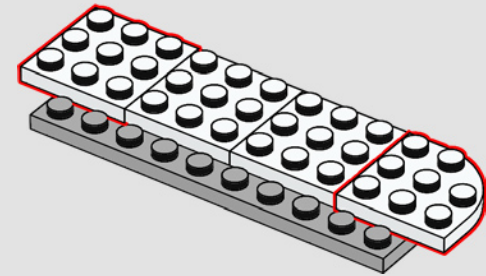

1x

1x

207

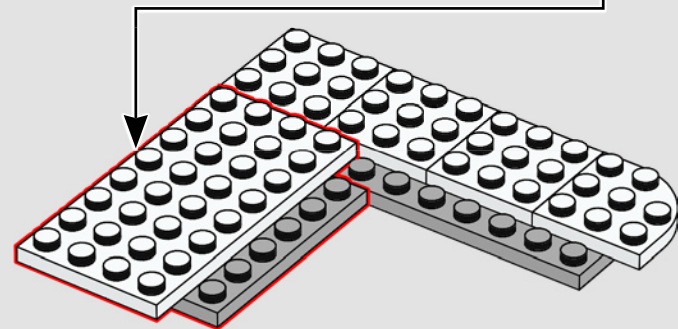
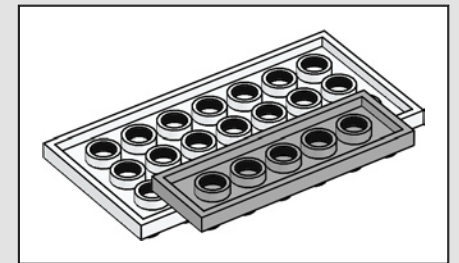

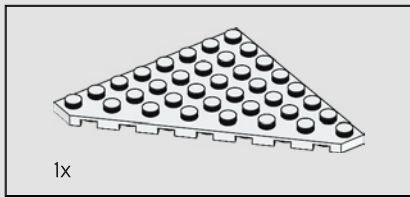

208

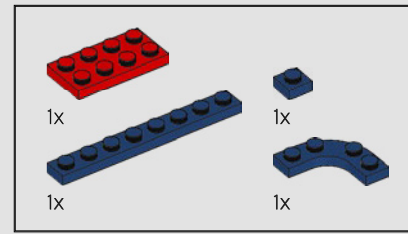
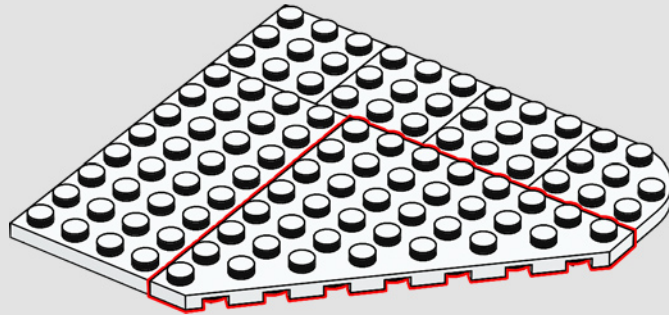

209

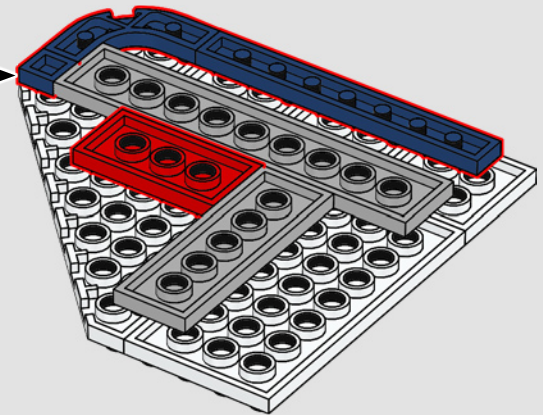
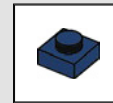

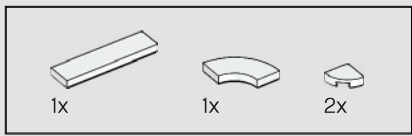

210

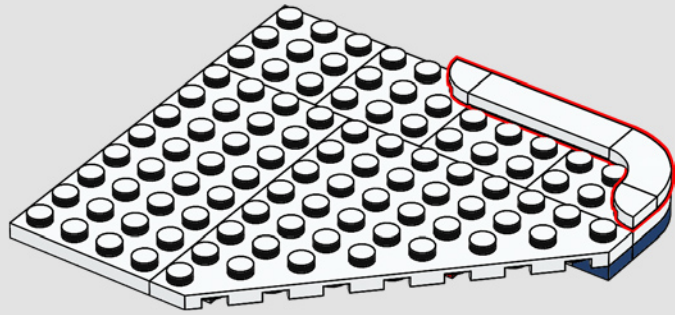

211

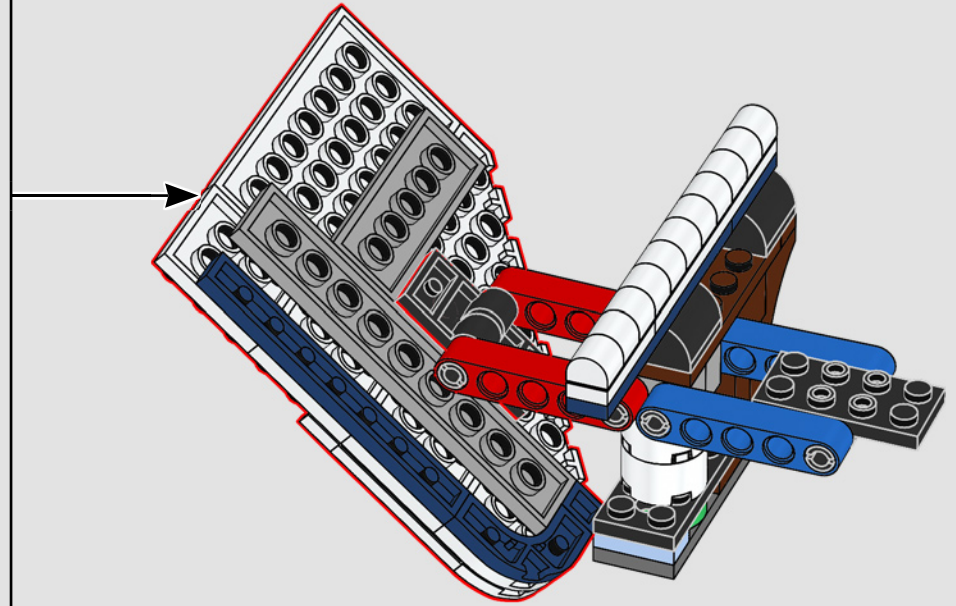

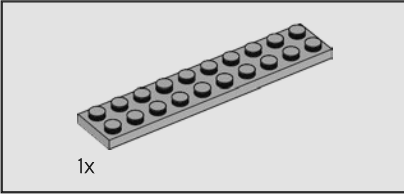
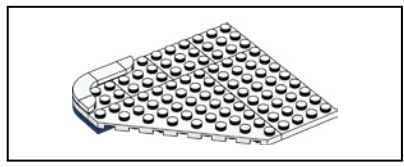

212

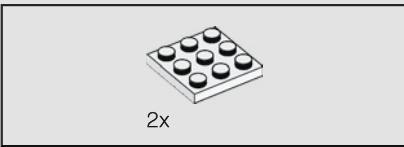
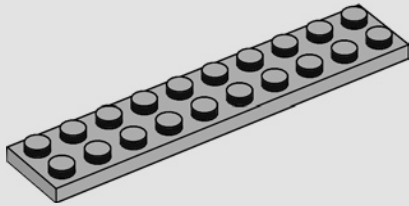

213

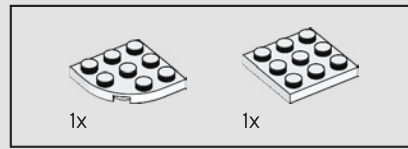
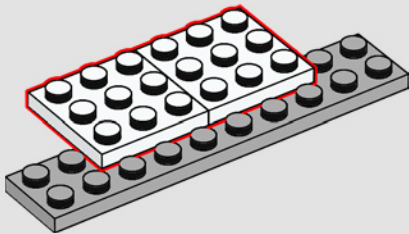

214

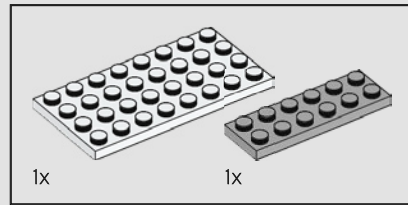
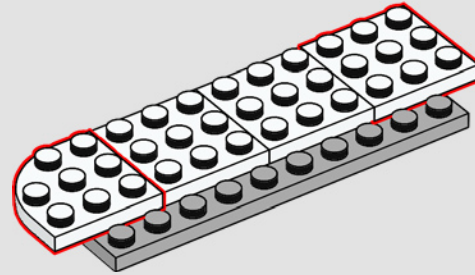

215

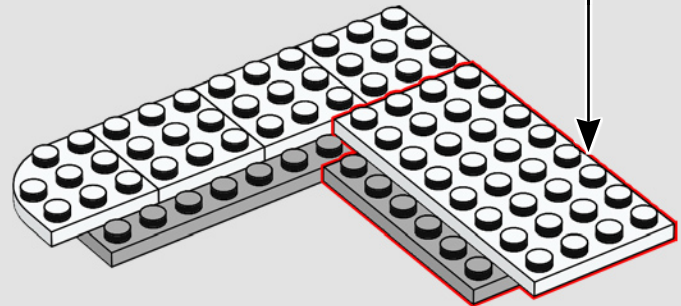
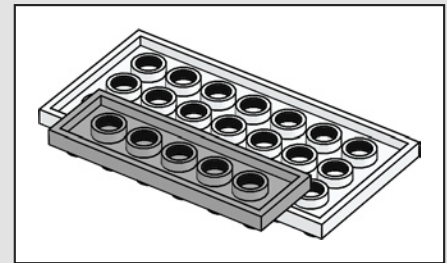

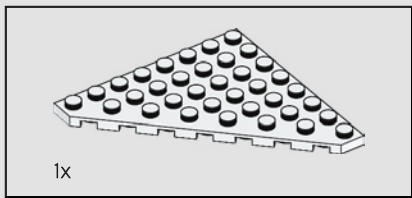

216

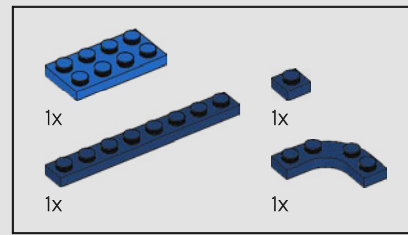
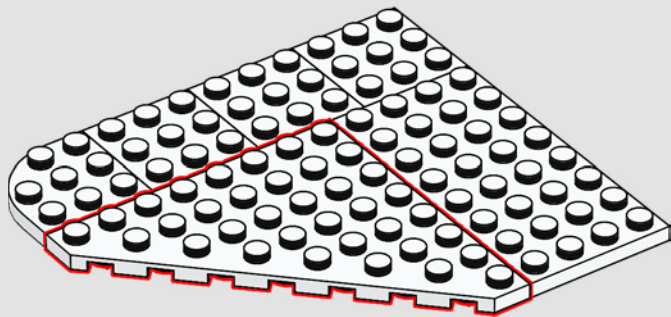

217

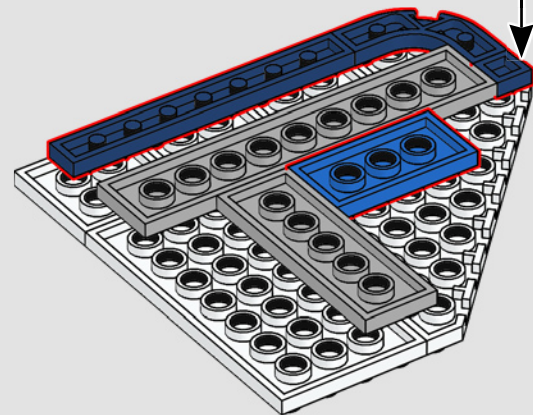
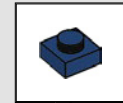

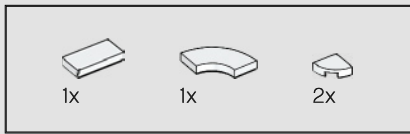

218

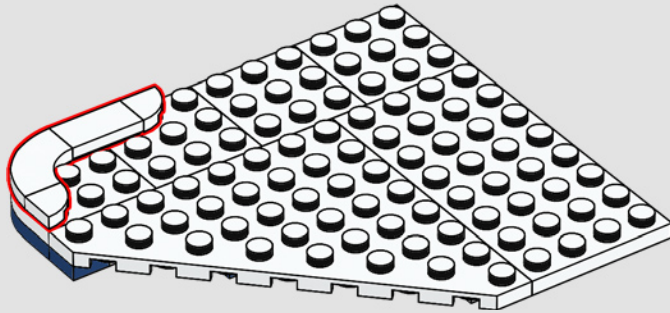

219

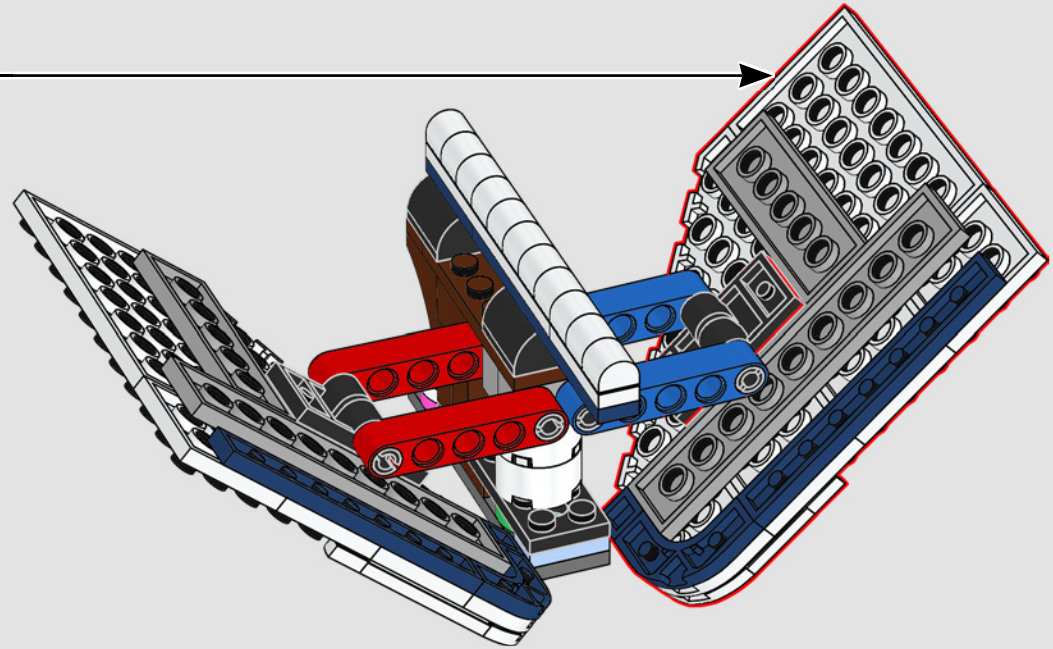

220

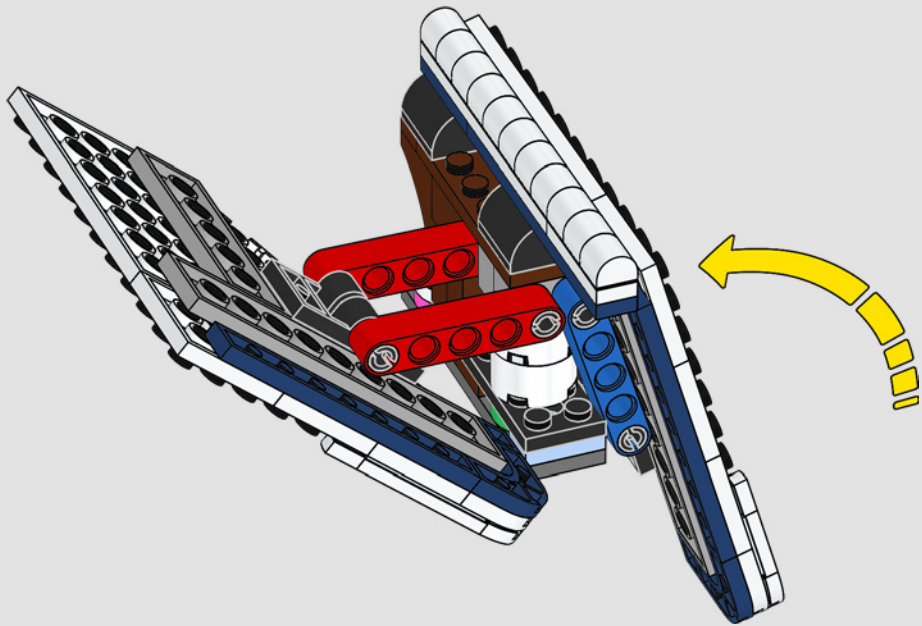

221

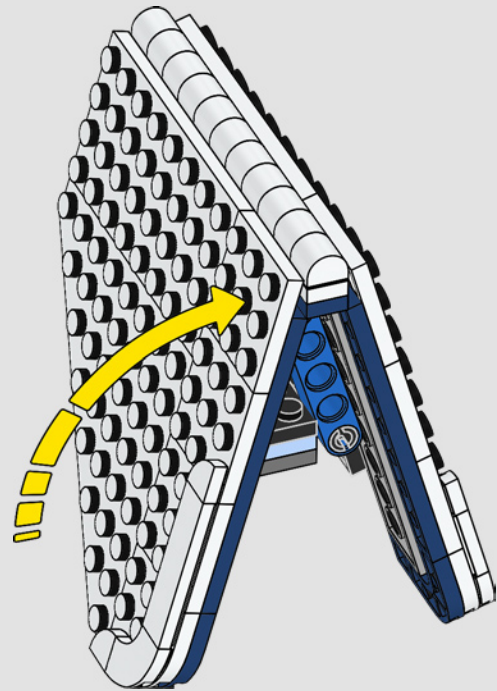

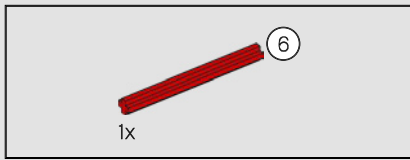

222

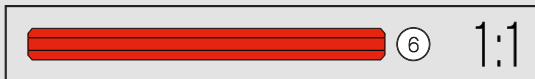
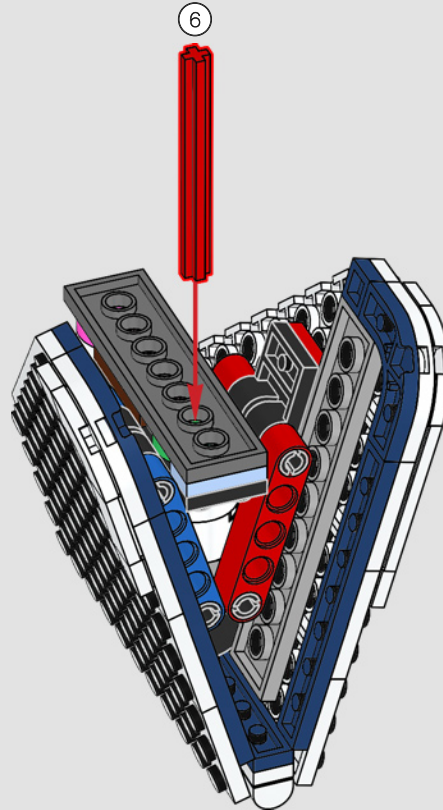

223

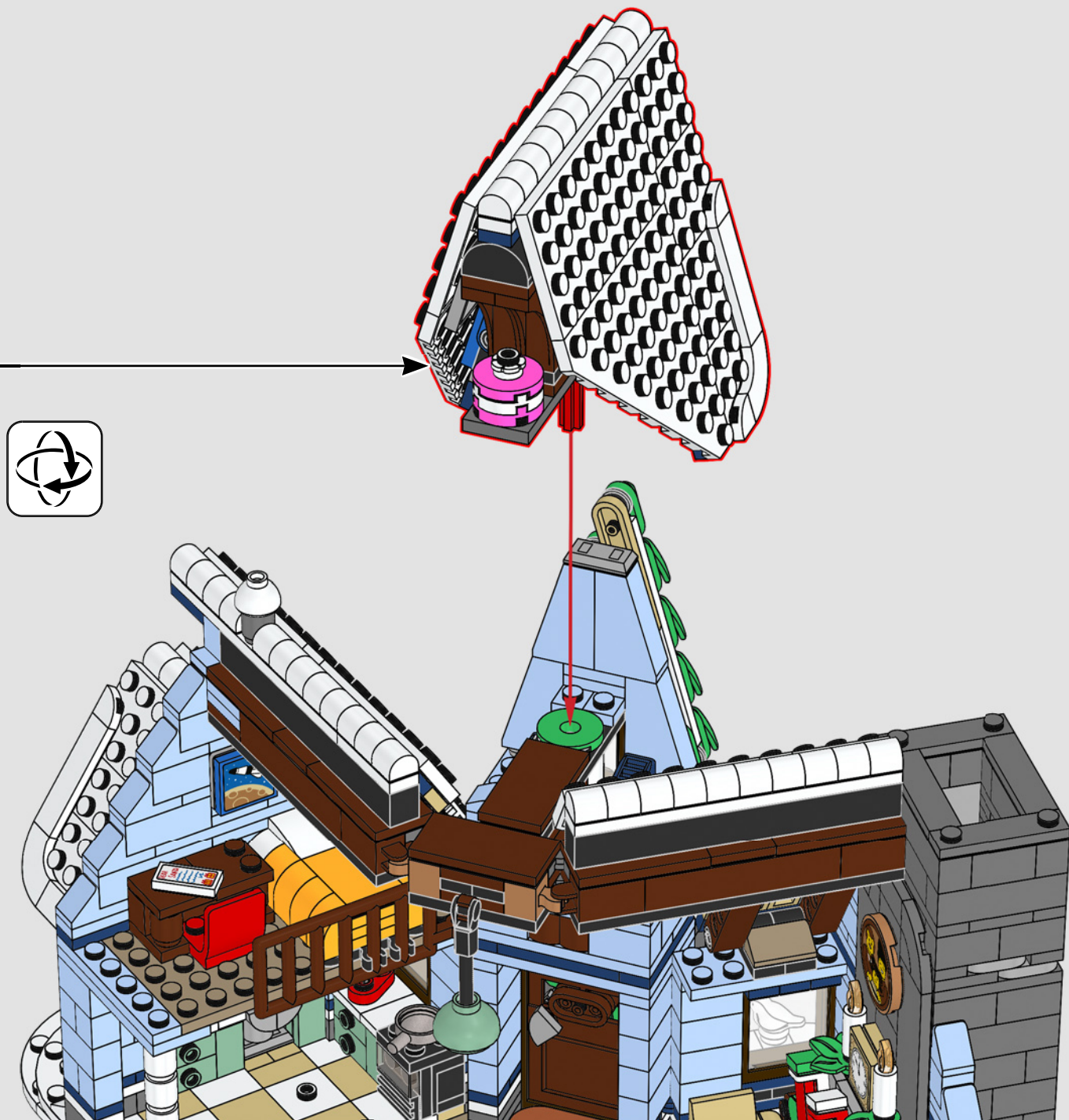

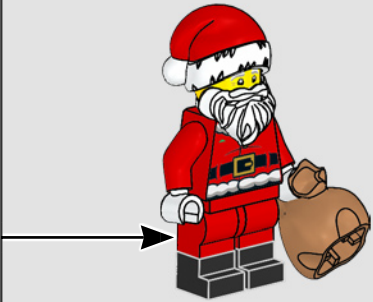
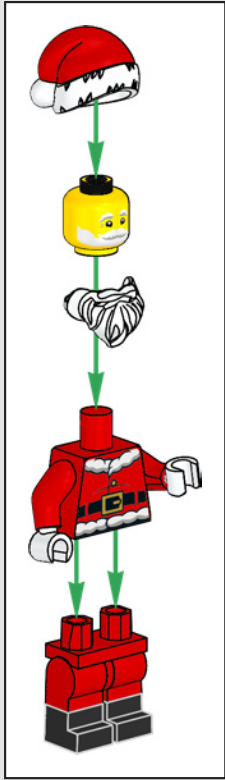

La minifigure di Babbo Natale è stata revisionata per questo set, con una nuova stampa del viso e del busto e nuove gambe a doppio stampo con un bel paio di grandi stivali neri, una novità in assoluto!

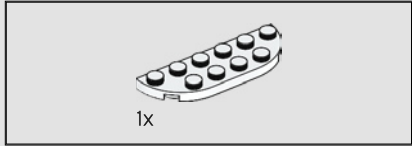
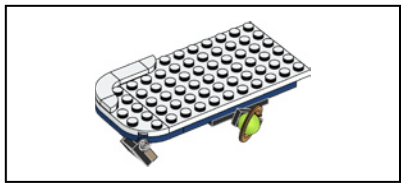

224

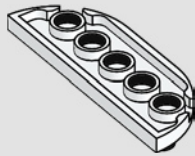

225

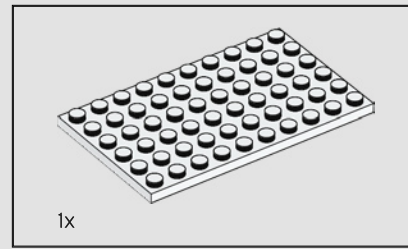
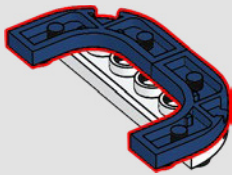

226

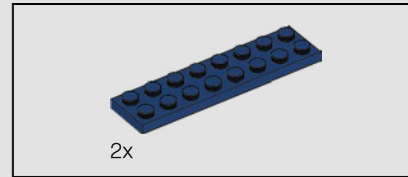
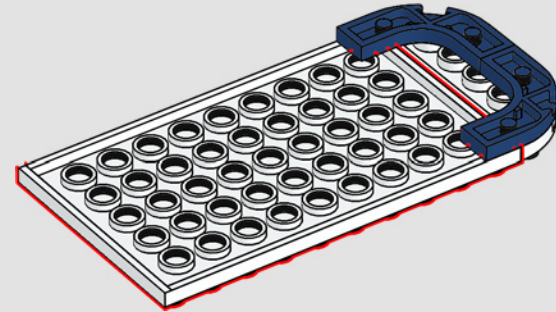

227

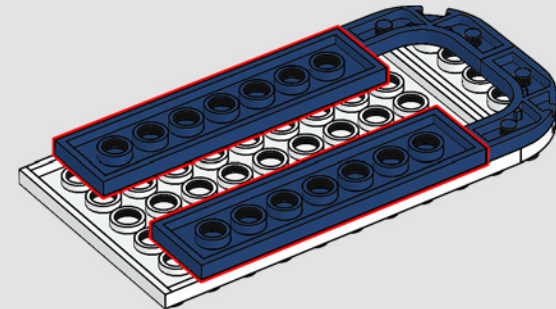

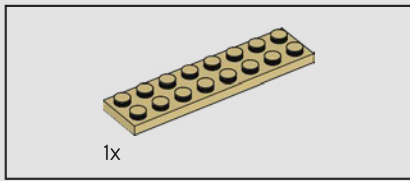

228

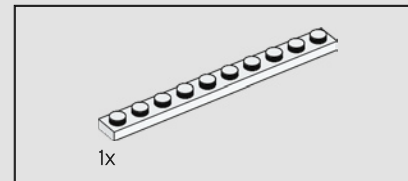
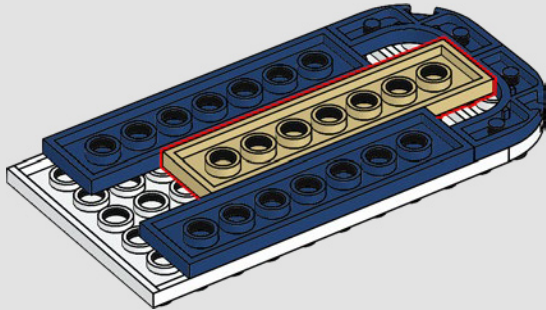

229

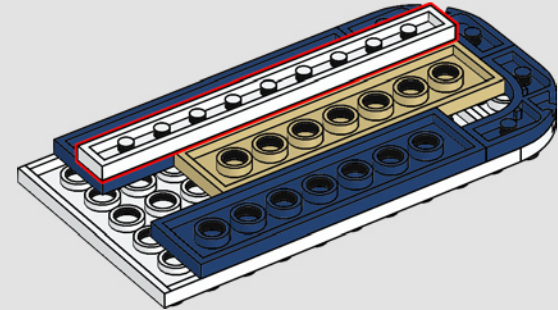

230

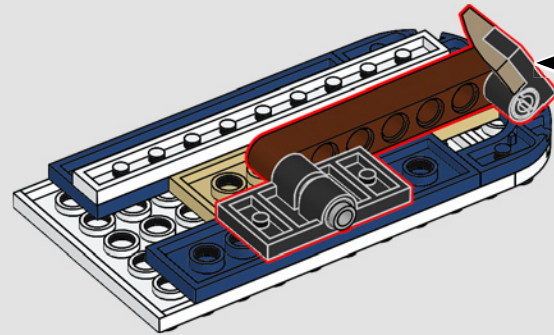
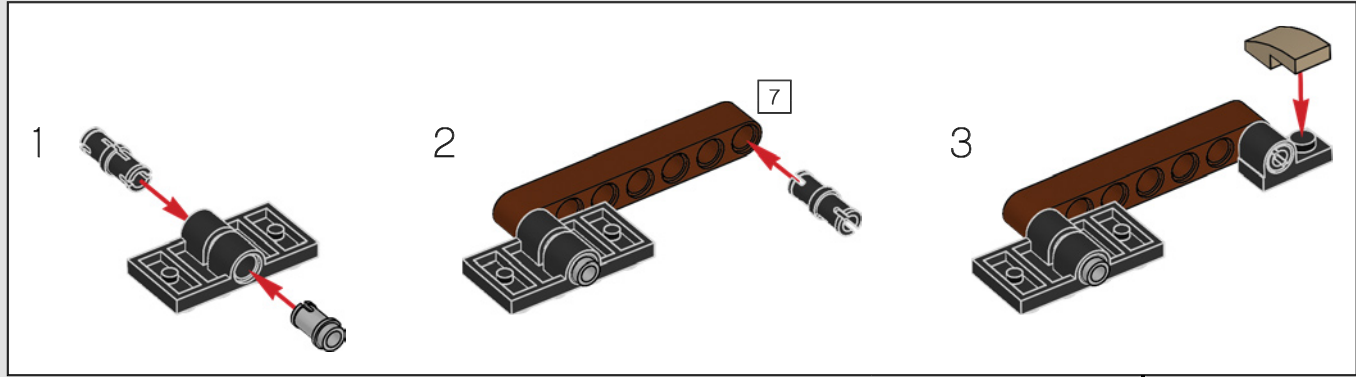
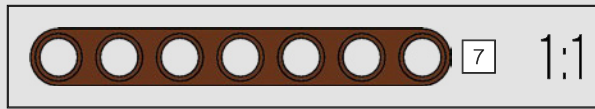
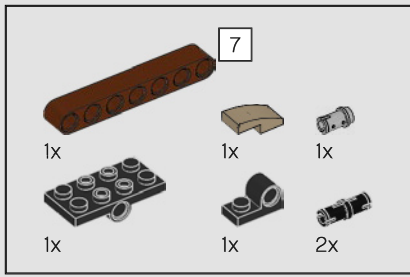

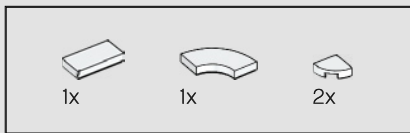

231

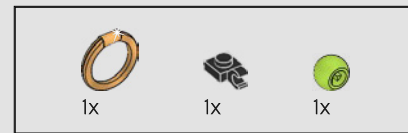
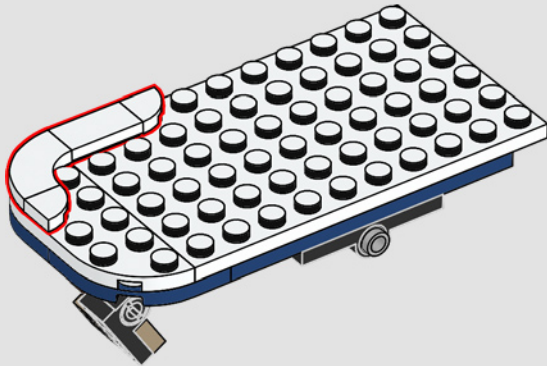

232

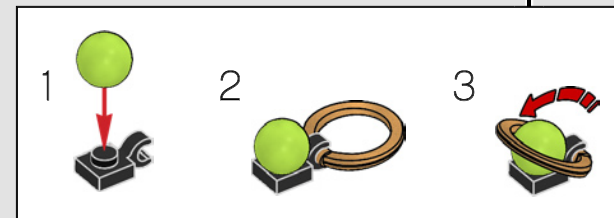
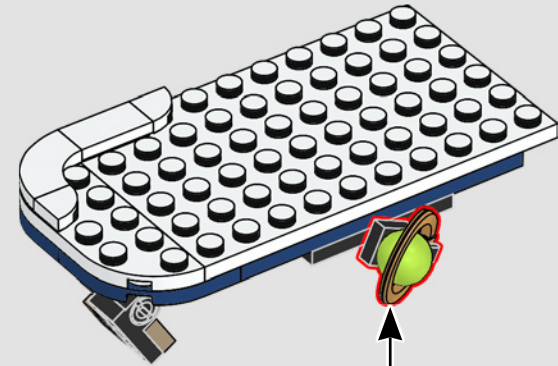

Il tetto sopra la stanza della bambina si apre per offrire un accesso più facile a questo spazio.

233

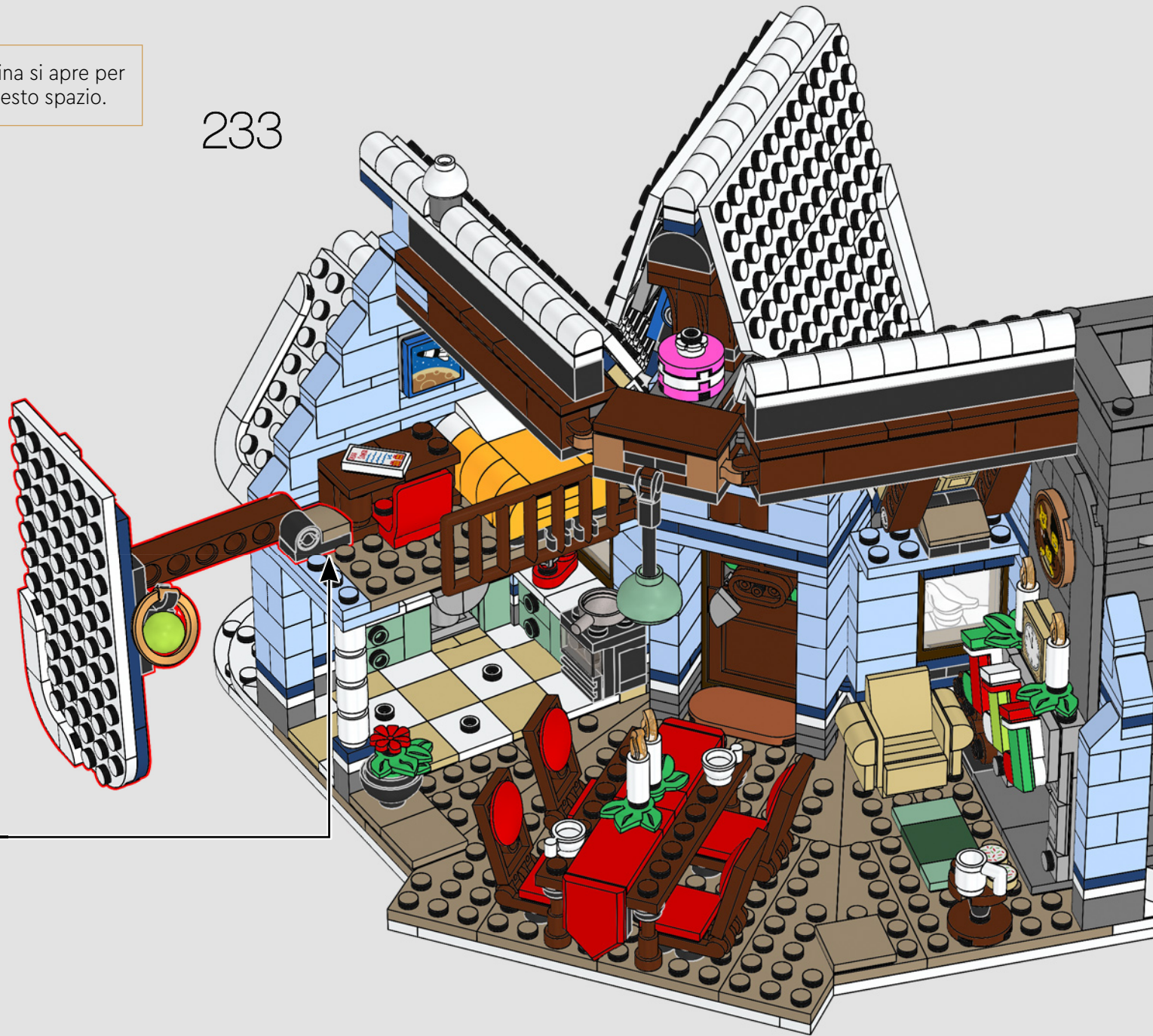

234



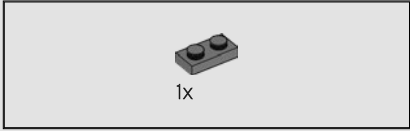
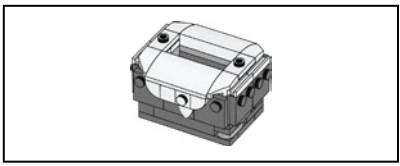

235

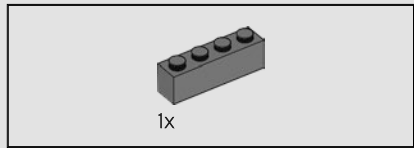
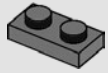

236

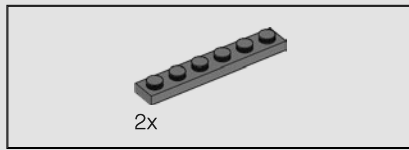
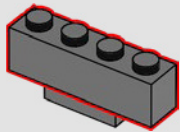

237

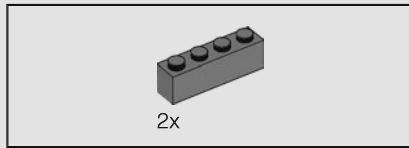
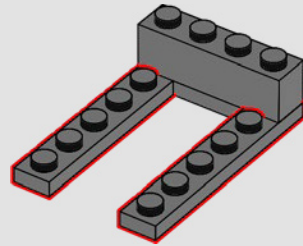

238

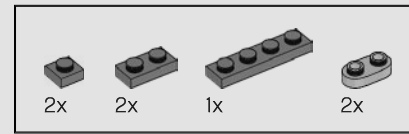
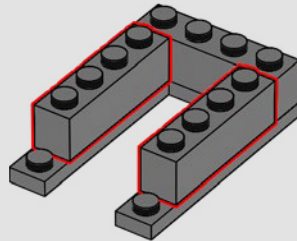

239

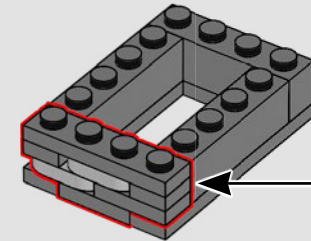
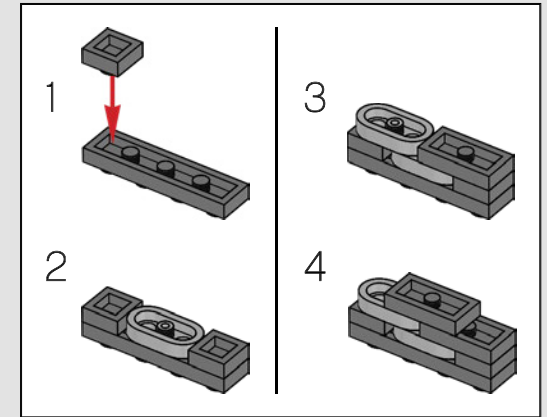

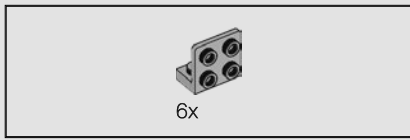

240

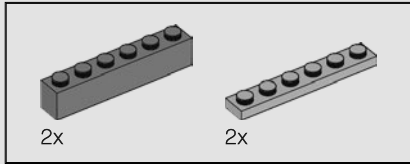
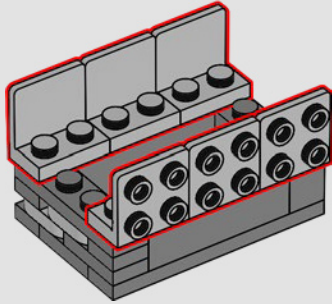

241

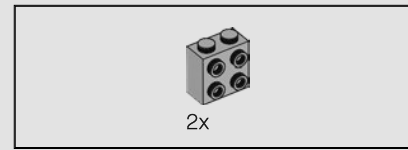
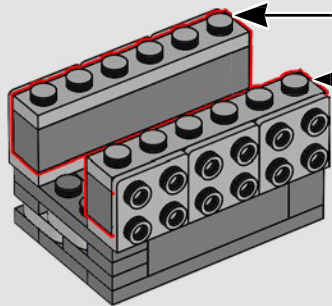
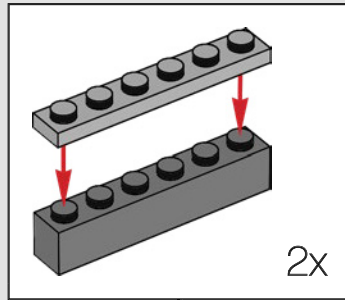

242

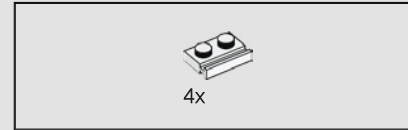
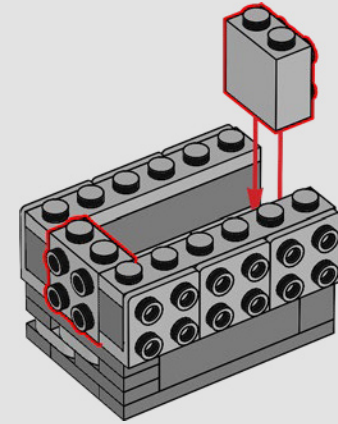

243

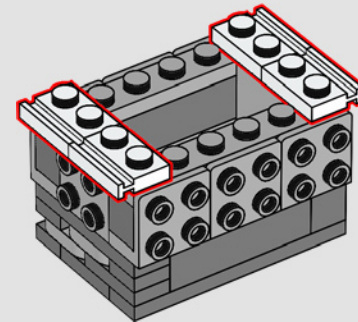

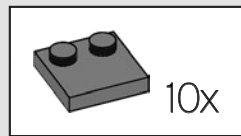
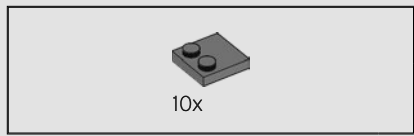

244

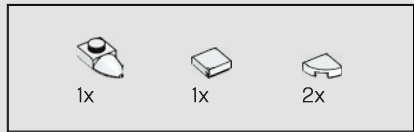
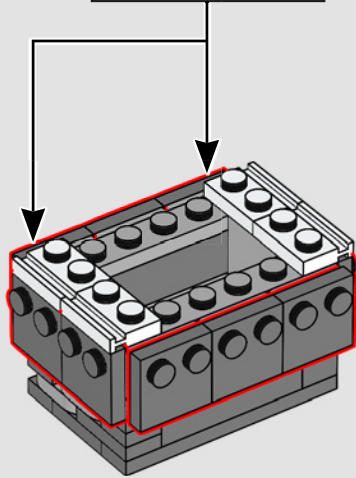

245

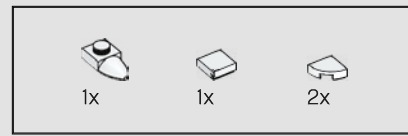
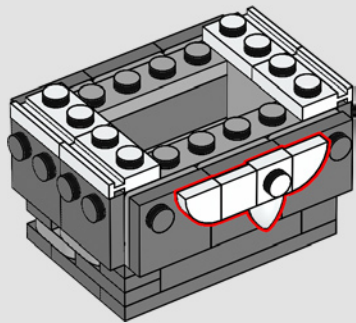

246

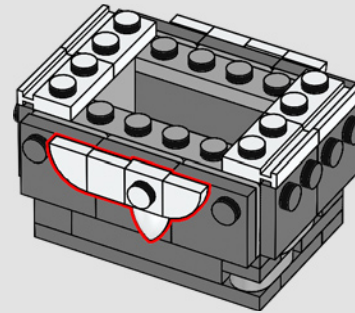
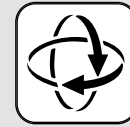

247

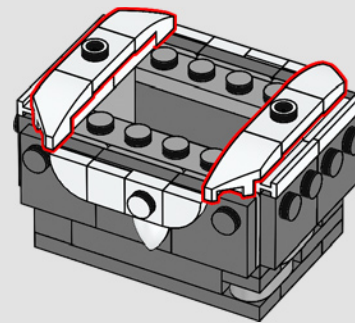

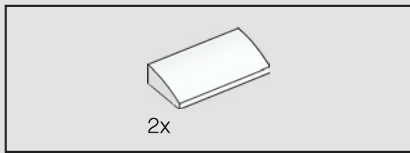

248

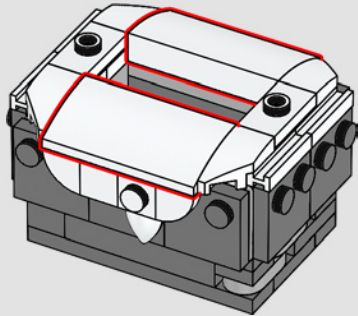

249



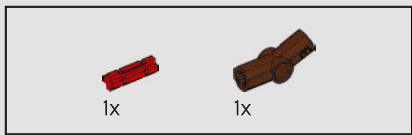

250

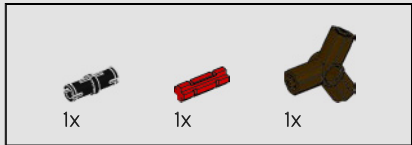

251

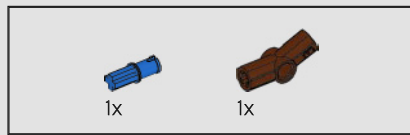
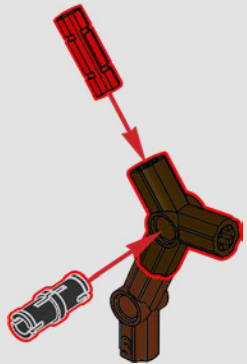

252

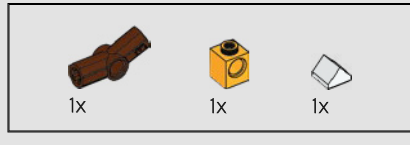
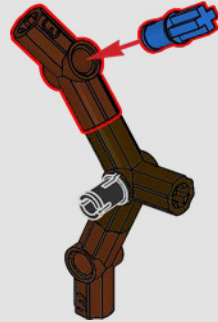

253

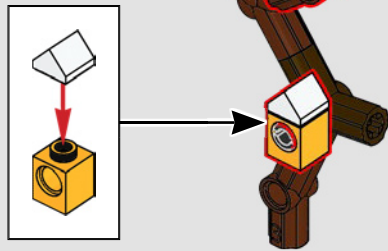

254

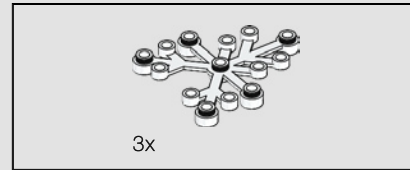
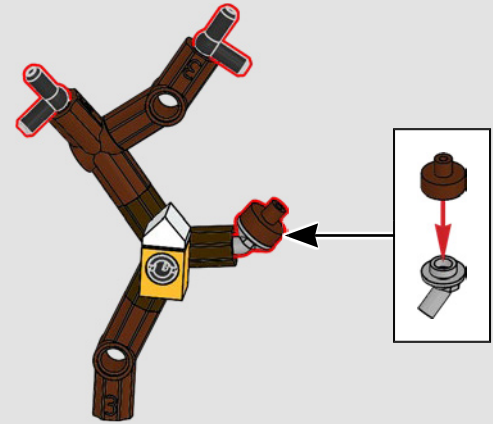

255

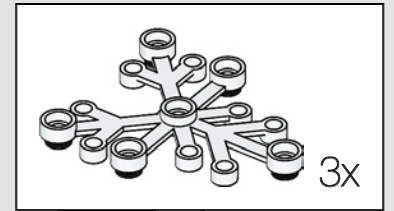
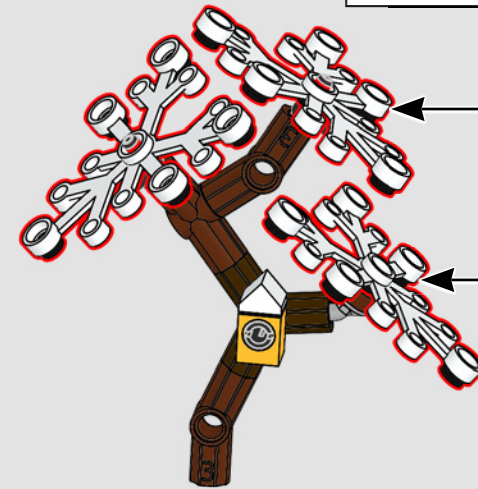

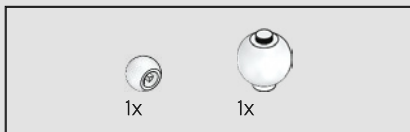

256

Questa è la prima volta che un albero a foglie decidue è stato incluso come parte di un set del Villaggio invernale. I suoi rami spogli sono coperti di neve, un tocco che sottolinea l'atmosfera invernale.

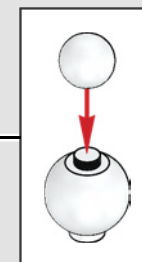
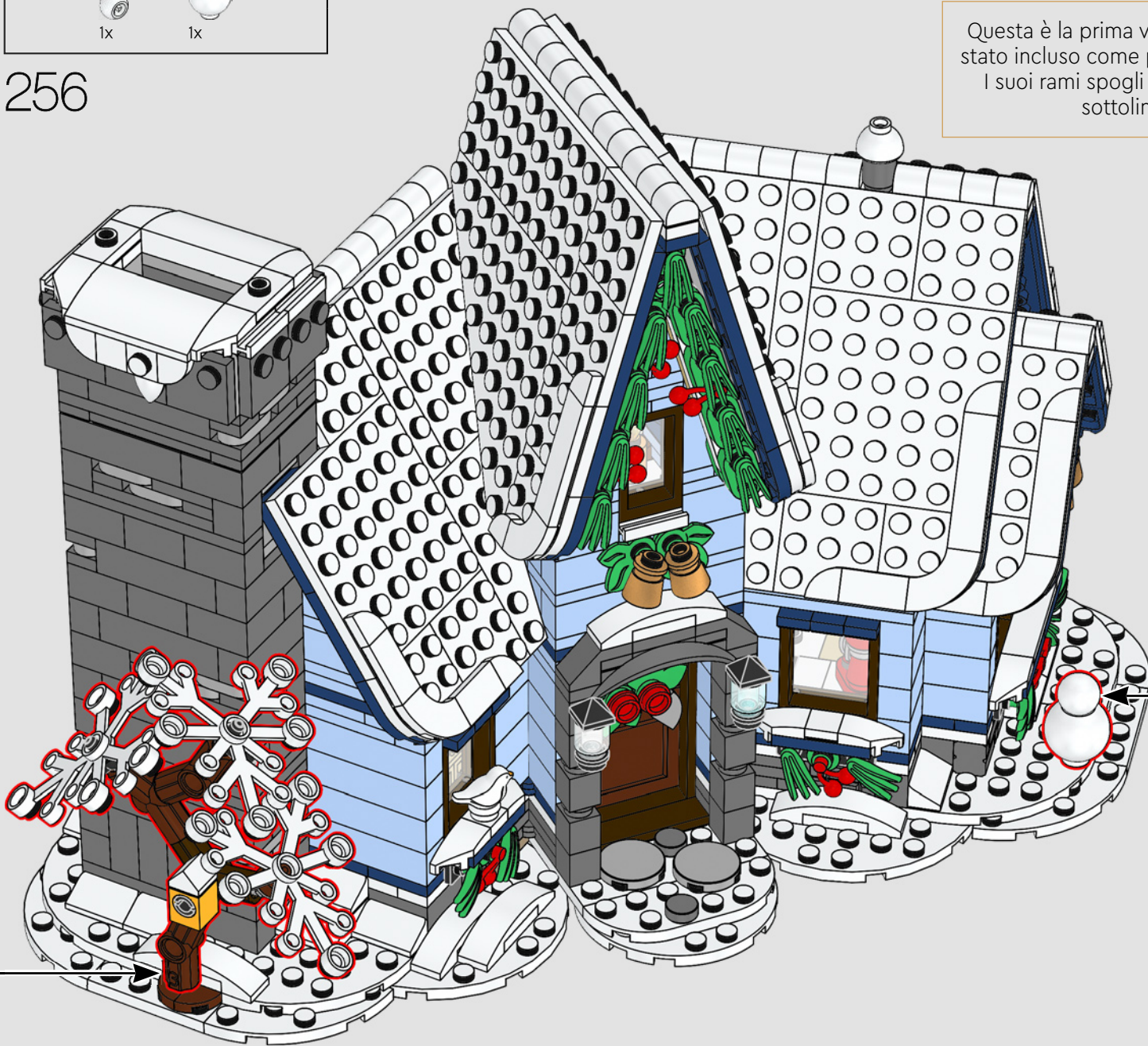

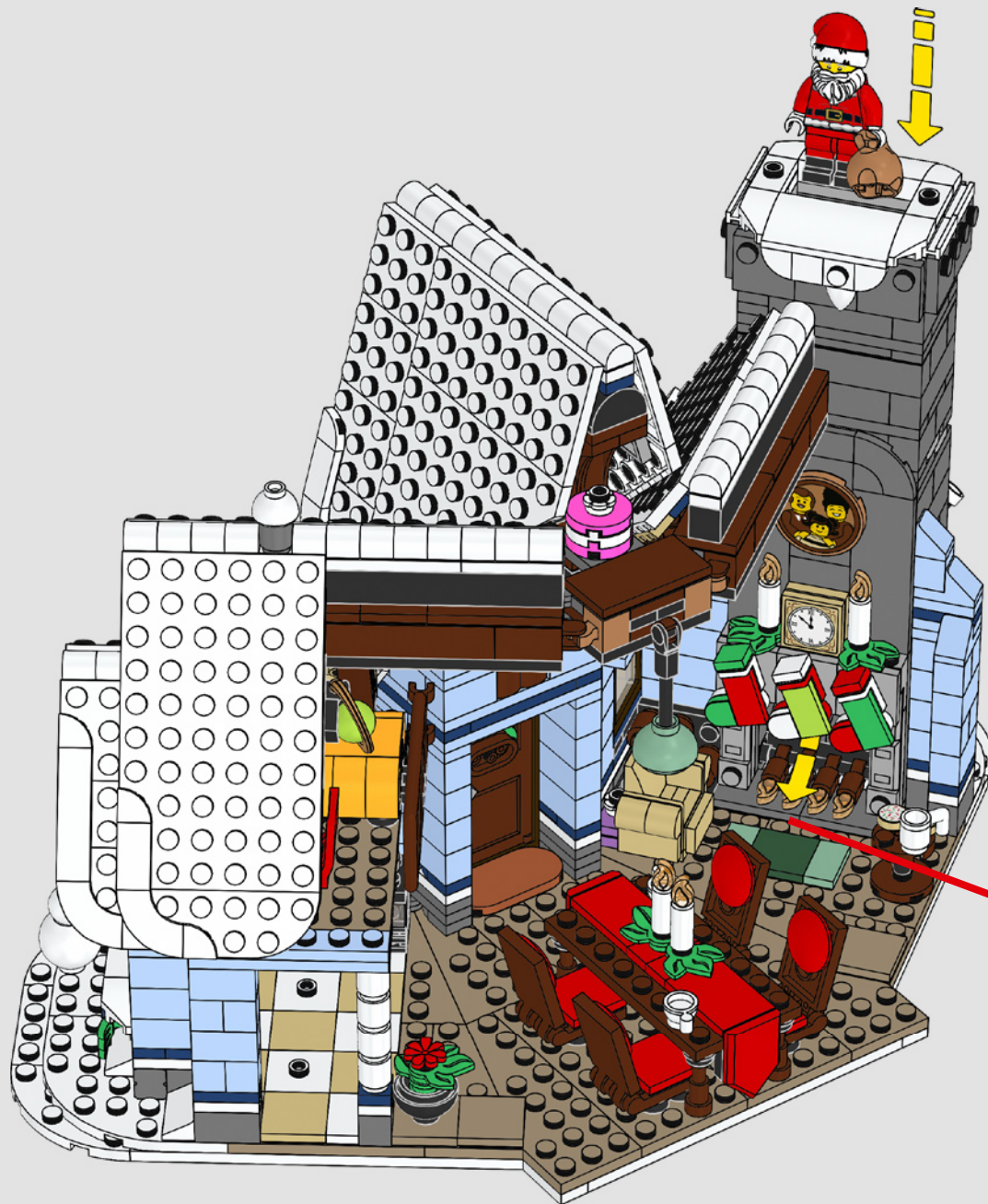

Babbo Natale può scendere giù attraverso il comignolo, buttare giù il fuoco ed entrare nel soggiorno.





Nel caso in cui Babbo Natale rimanga incastrato nel comignolo, la parte superiore può essere rimossa!



FEEDBACK AND WIN



FEEDBACK AND WIN

Your feedback will help shape the future development of this product series.

Please visit:

FEEDBACK UND GEWINNEN

Dein Feedback trägt zur Weiterentwicklung dieser Produktreihe bei.

Geh auf:

COMMENTEZ ET GAGNEZ

Vos commentaires nous aideront à concevoir les futurs produits de cette gamme.

Rendez-vous sur :

COMENTA Y GANA

Tu opinión nos ayudará a dar forma al desarrollo de esta serie de productos en el futuro.

Visita:

反馈有奖

您的反馈将有助于我们在今后改进本系列产品。

请访问：

[LEGO.com/productfeedback](https://www.lego.com/productfeedback)

By completing, you will automatically enter a drawing to win a LEGO® set.

Terms & Conditions apply.

Durch Ausfüllen nimmst du automatisch an der Verlosung eines LEGO® Preises teil.

Es gelten die Teilnahmebedingungen.

En envoyant vos commentaires, vous serez automatiquement inscrit(e) à un tirage au sort qui vous permettra de remporter un prix LEGO®.

























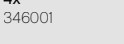
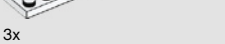

















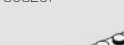



















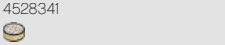









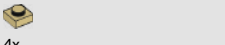









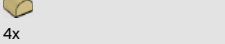







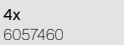
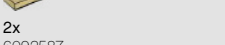









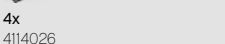







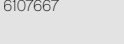
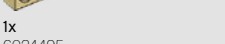









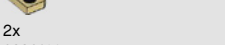









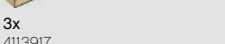









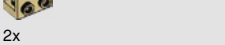









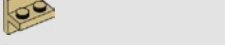









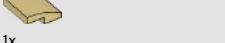

Offre soumise à conditions.

Al contestar, participarás automáticamente en el sorteo y podrás ganar un set LEGO®.

Sujeto a Términos y Condiciones.

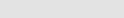
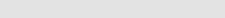
完成我们的反馈调查，即可自动进入抽奖环节，赢取乐高®套装。

适用《条款和条件》。

 4x 6234807	 1x 4659665	 11x 306901	 7x 243101	 4x 346001	 3x 244501	 6x 4185177	 1x 4558886	 2x 6189130	 2x 300524
 4x 306201	 1x 4610044	 5x 4249563	 4x 371001	 2x 303201	 2x 4585737	 1x 6173057	 1x 307021	 2x 302021	 1x 6152800
 3x 6206149	 2x 4224792	 1x 4287707	 8x 6023806	 2x 303201	 2x 4585737	 1x 4121921	 1x 6249907	 2x 4142132	 1x 6152450
 1x 4518400	 1x 6331225	 1x 4287708	 13x 6104805	 2x 6138699	 1x 4528341	 1x 4113233	 1x 6345637	 2x 4142132	 1x 6152450
 1x 6186681	 2x 6210272	 1x 4287708	 6x 4550745	 2x 6138699	 3x 6361753	 4x 6311104	 3x 6210269	 1x 6130002	 1x 6362427
 1x 6250591	 5x 6213881	 1x 4287708	 2x 4583297	 2x 4144012	 4x 4159553	 1x 4114309	 1x 6298924	 4x 303421	 1x 6170421
 1x 6253309	 10x 4547489	 5x 6126046	 3x 6147792	 4x 6057460	 4x 6286329	 1x 4114309	 4x 4278275	 4x 303421	 1x 6267163
 1x 6338913	 1x 6221773	 2x 306801	 10x 366601	 4x 6107667	 4x 4114026	 1x 4113988	 4x 4142865	 1x 306823	 1x 6290456
 1x 6052864	 1x 403201	 1x 6047220	 3x 6147792	 2x 6107667	 2x 6092587	 1x 4113988	 1x 6381759	 1x 306823	 1x 6290456
 3x 6235083	 4x 614301	 7x 6172674	 10x 366601	 4x 447701	 4x 4114026	 2x 4626948	 1x 4650646	 1x 302023	 1x 6210496
 1x 6221783	 4x 614301	 2x 6058329	 2x 4243812	 4x 447701	 1x 6024495	 1x 4529234	 2x 6092565	 2x 4142134	 1x 6321194
 46x 6258135	 1x 6055830	 1x 242001	 6x 4178429	 4x 447701	 2x 6236914	 14x 614121	 5x 302321	 6x 614124	 2x 6284070
 3x 302401	 7x 6051511	 1x 6046979	 1x 6109817	 4x 447701	 3x 4113917	 1x 6258973	 1x 306921	 1x 6270417	 1x 6056234
 5x 307001	 1x 6051511	 1x 6046979	 1x 6109817	 4x 447701	 2x 6174925	 1x 6100565	 4x 306821	 1x 6270417	 9x 6168646
 16x 6172366	 2x 6285777	 3x 362301	 1x 6109817	 4x 447701	 2x 6174925	 7x 6100565	 1x 6258973	 1x 6270417	 1x 6056234
 1x 6286834	 1x 6329597	 1x 6362428	 3x 6266969	 3x 6266969	 1x 6253003	 1x 6182260	 1x 407921	 1x 6352820	 1x 6227901
 5x 6213880	 12x 302301	 1x 6362428	 2x 6266969	 2x 6266969	 1x 6046924	 1x 6224794	 2x 6294045	 1x 6226749	 2x 6312449
 3x 6242241	 1x 6261349	 2x 302101	 2x 379501	 1x 4503008	 1x 6046924	 1x 6224794	 2x 6294045	 1x 6226749	 2x 6312449

2x 6299338	3x 6117973	2x 611126	2x 306928	1x 6322126	2x 6015449	8x 4184108	1x 6251292	1x 4504376	2x 4216695
1x 6308000	1x 6310268	2x 611126	8x 6226931	4x 4157103	1x 6021969	2x 6199890	1x 4624381	2x 6062574	1x 6196221
2x 6104209	1x 6093525	2x 383226	4x 302328	1x 6240515	1x 6028018	1x 4162916	1x 4220634	1x 6123038	2x 4211210
10x 6210270	1x 6093525	17x 6329651	4x 4121969	3x 6328131	1x 6028018	6x 6092588	1x 4500125	1x 6248944	2x 4211210
3x 6196548	2x 302226	1x 4529239	8x 6297286	1x 6258323	1x 6028022	2x 6251248	9x 6357747	1x 6248944	4x 6221608
2x 6330189	2x 4200023	6x 6338221	8x 4107637	5x 4616578	2x 4507045	7x 4528981	1x 6318085	1x 6102360	8x 6102975
1x 6269081	2x 4515368	1x 6250600	1x 6359041	1x 6258323	1x 6126075	3x 6363600	3x 6028736	3x 4211180	3x 6261388
1x 6102341	1x 6162892	1x 4558593	2x 6240030	4x 4616578	1x 6126075	4x 4528482	8x 6374487	1x 6172808	2x 6055086
19x 6279875	1x 302126	8x 4546705	4x 6244796	4x 6184432	4x 4550329	3x 4177735	1x 6286881	1x 6313124	1x 6103769
1x 6259045	1x 302026	4x 302428	4x 6252041	2x 6184348	2x 4530712	6x 4530028	1x 6097511	4x 6103004	2x 4211189
1x 9339	1x 302026	4x 6290602	1x 6184348	1x 6101254	2x 4530712	11x 4502089	4x 6341968	6x 4211150	2x 4211189
1x 300426	5x 6194233	11x 6210271	1x 6252258	4x 6101254	2x 4530712	8x 6361984	7x 4211183	4x 6310449	1x 4216668
1x 241226	1x 300126	13x 6229130	4x 6278710	3x 6002849	2x 6006524	2x 6135593	3x 6186673	2x 6234272	2x 6150305
5x 6114987	1x 300126	1x 6074954	20x 6240204	3x 6002849	2x 6006524	6x 6250216	10x 4211242	1x 6338135	2x 6150305
1x 302326	2x 6138405	1x 403228	2x 6251294	3x 6002851	1x 6096215	3x 6027627	2x 6149677	1x 4565394	1x 4211225
5x 6016172	2x 3200126	1x 6189162	2x 6239418	3x 6002851	1x 6096215	3x 6027627	2x 4221744	2x 4271949	4x 6348062

- 4x 6307618
- 2x 4579690
- 2x 6044725
- 2x 4221590
- 1x 6070442
- 1x 4243838
- 2x 4216615
- 1x 4211247
- 5x 6179614
- 1x 6030812
- 1x 4211207

- 1x 6247795
- 1x 6249246
- 1x 6326748
- 3x 4211525
- 2x 4211483
- 4x 6176433
- 1x 6262085
- 2x 4211399
- 12x 6248890
- 1x 6311384
- 2x 6227897
- 4x 6052200
- 1x 4593679
- 2x 4211541
- 6x 6134378
- 7x 6123809

- 8x 4654580
- 3x 6126082
- 4x 4211353
- 2x 4654577
- 6x 4211396
- 1x 6226541
- 1x 4211441
- 3x 4211445
- 2x 4211438
- 3x 4211452
- 3x 4211462
- 12x 6285271
- 23x 6361987

- 2x 6335524
- 2x 6361990
- 4x 6132424
- 4x 6136397
- 24x 6362254
- 40x 6100322
- 12x 6182777
- 3x 6361991
- 10x 6361988
- 16x 6287903
- 2x 6132418
- 6x 6361985
- 10x 6132422

- 1x 4211090
- 4x 6284596
- 4x 4210633
- 11x 4211098
- 23x 4210719
- 2x 6362259
- 4x 6199549
- 4x 6228923
- 20x 4211088
- 2x 6019987
- 1x 6092572
- 4x 6000311
- 2x 6168776
- 1x 6261355
- 1x 4211052
- 17x 4211063
- 1x 4543086

- 1x 4211094
- 10x 6309059
- 12x 4211109
- 2x 4210635
- 2x 6265306
- 5x 4211133
- 3x 4211104
- 4x 6172811
- 3x 6187008
- 13x 4211103
- 4x 6257592
- 11x 4211001
- 2x 4211053
- 12x 6102774
- 1x 6307616

- 1x 6362257
- 5x 4211100
- 1x 4620760
- 7x 4211056
- 2x 6321746
- 1x 4260707
- 2x 6252838
- 1x 6060800
- 1x 6190252
- 4x 6173139
- 1x 6034543
- 4x 6335111

- 1x 6286094
- 1x 6093529
- 1x 4528778
- 4x 6022105
- 1x 6259766
- 1x 6273219
- 4x 6331950
- 1x 6313874
- 1x 6337282

- 1x 6326495
- 1x 6223767
- 2x 6296061
- 2x 6360035
- 1x 6076674
- 1x 6218360
- 1x 6326106
- 1x 4624615
- 4x 6102986
- 2x 4619512
- 2x 6312455
- 3x 6363601

7



Customer Service
Kundenservice
Service Consommateurs
Servicio Al Consumidor
LEGO.com/service or dial

: 00800 5346 5555
: 1-800-422-5346

