



# STAR WAR



10225



1

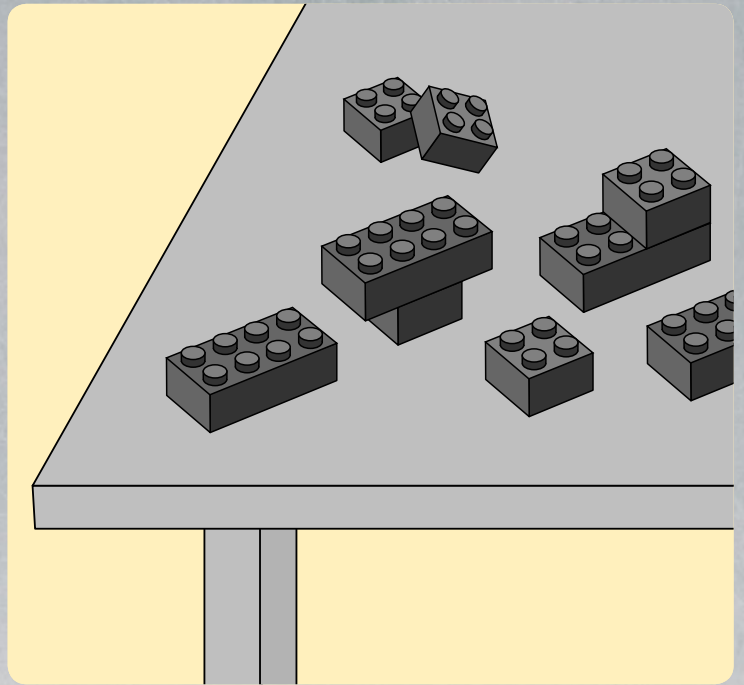
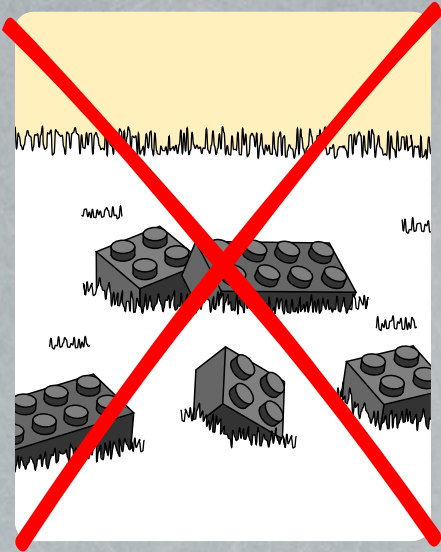

2

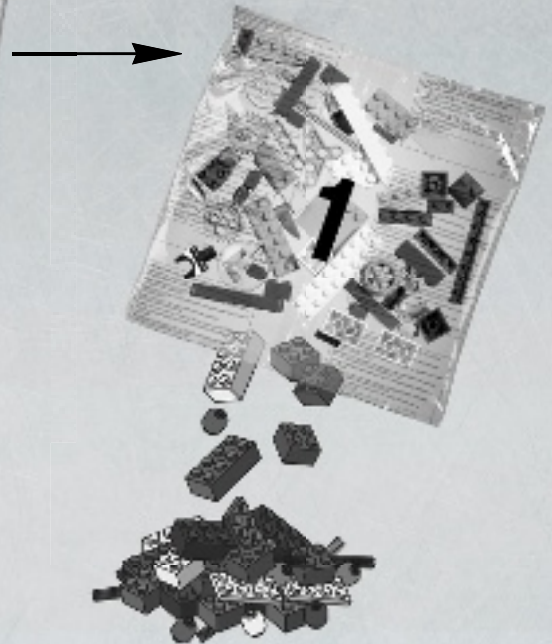



1



4

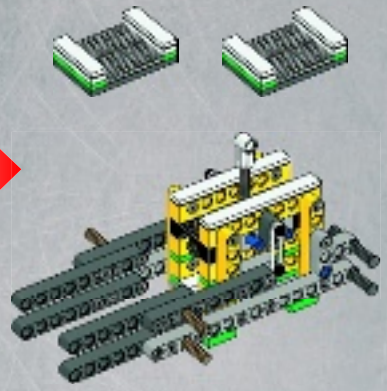

2

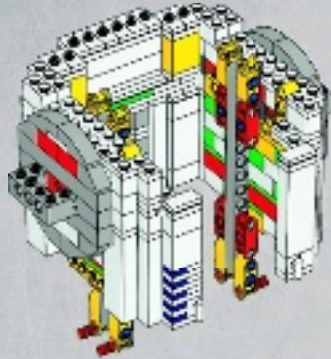

5

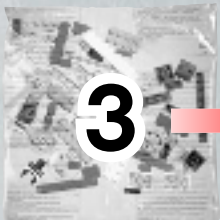
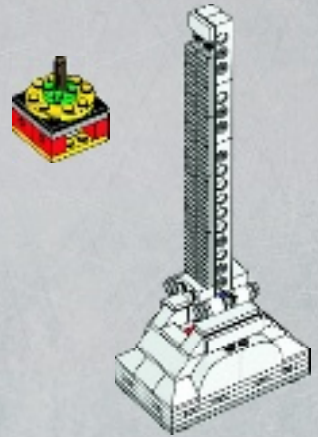
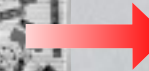

3

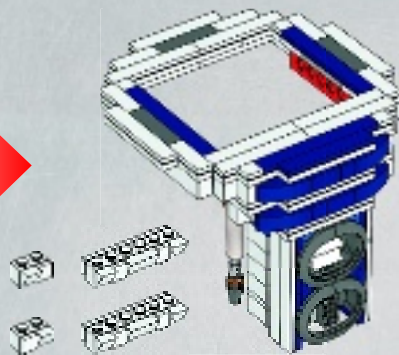

6

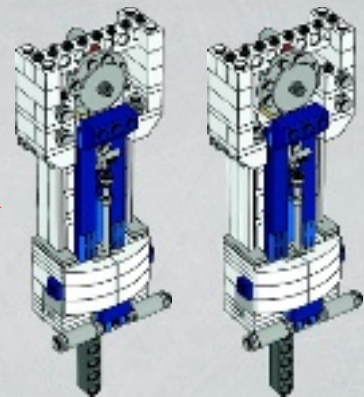



7

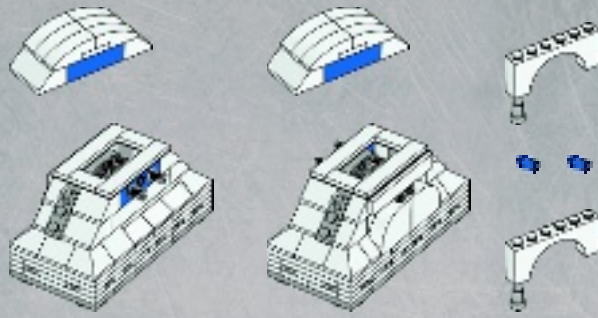

8



9

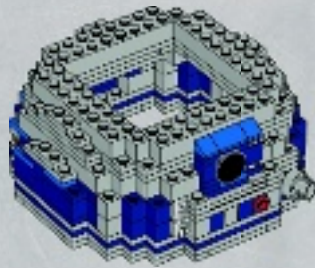

10



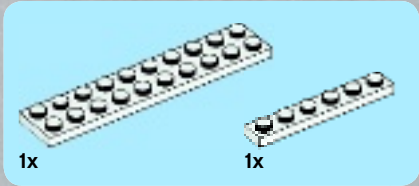
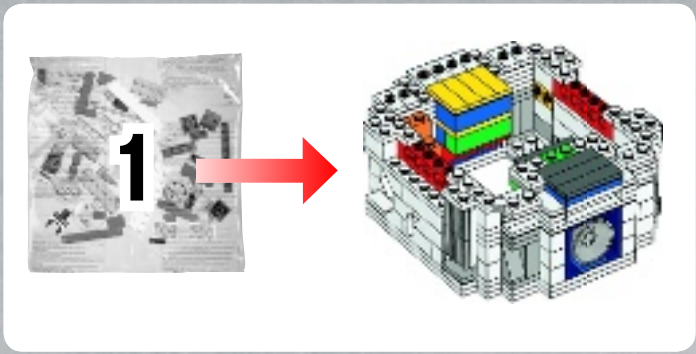

1

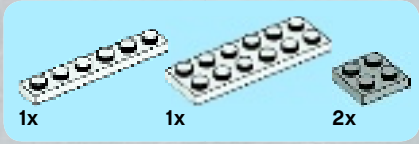
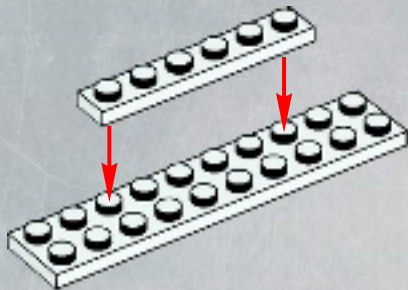

2

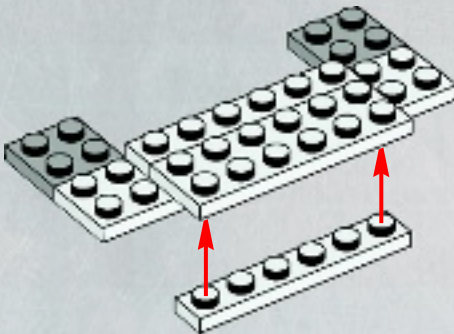

3

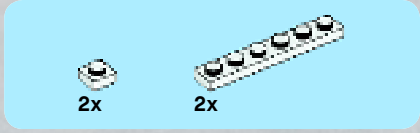
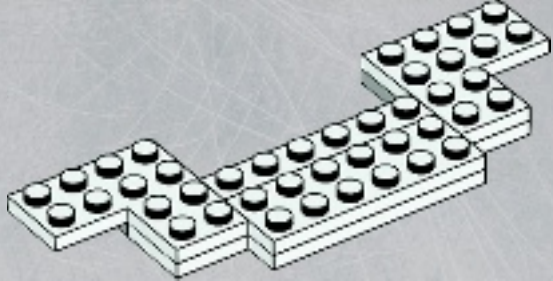

4

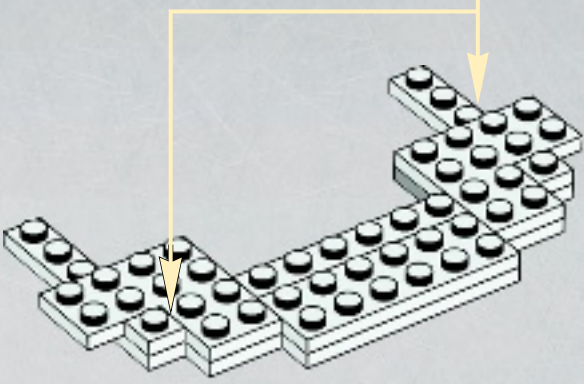
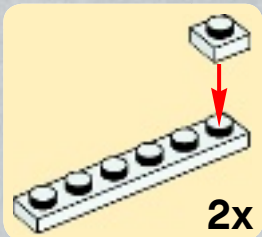

2x 5

1

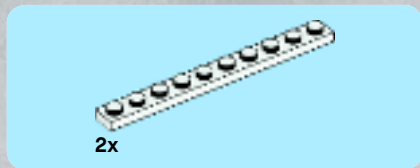
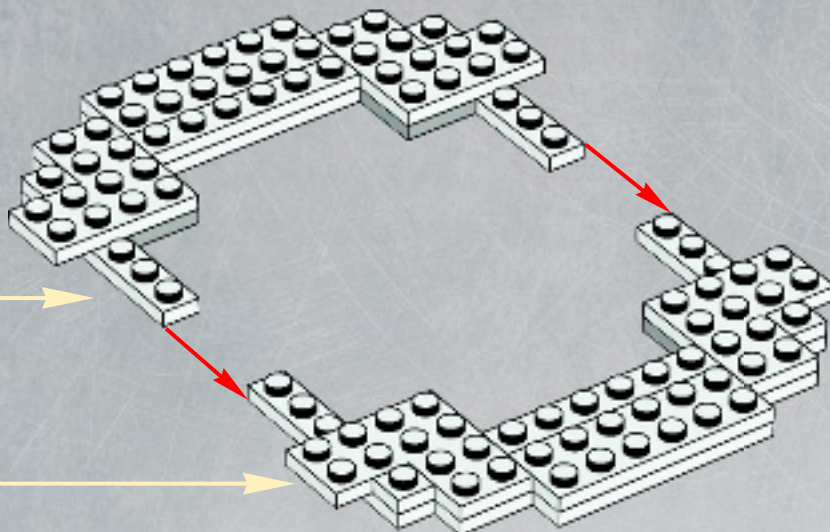

2

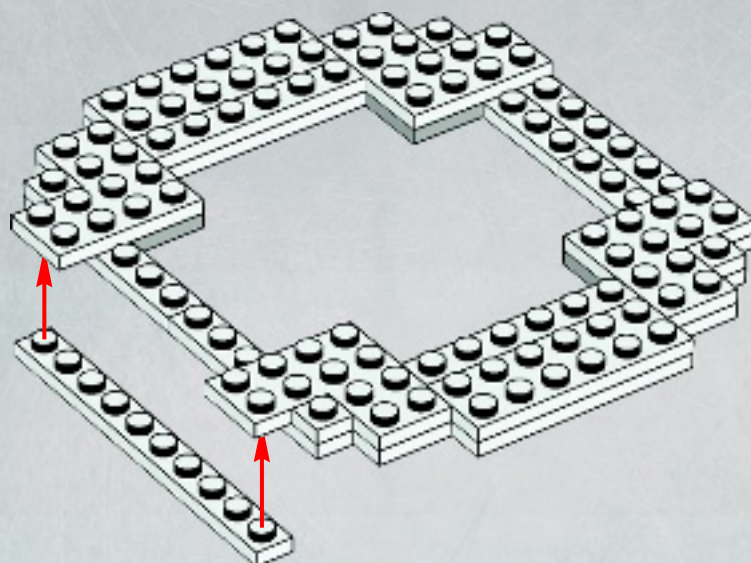



2x

# 3

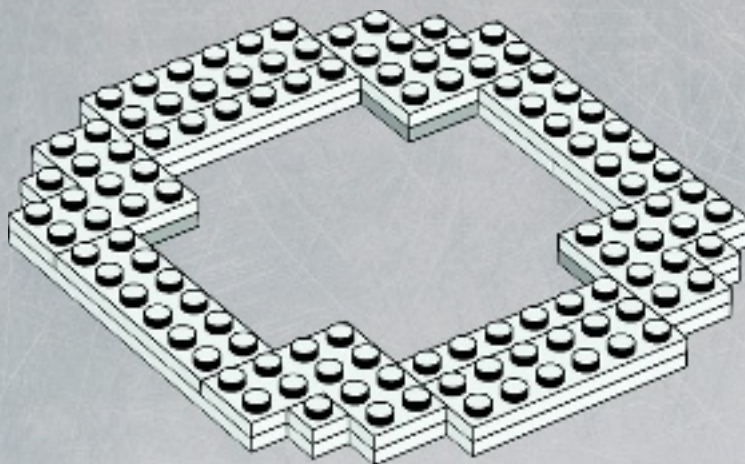

2x



4x



4x

# 4

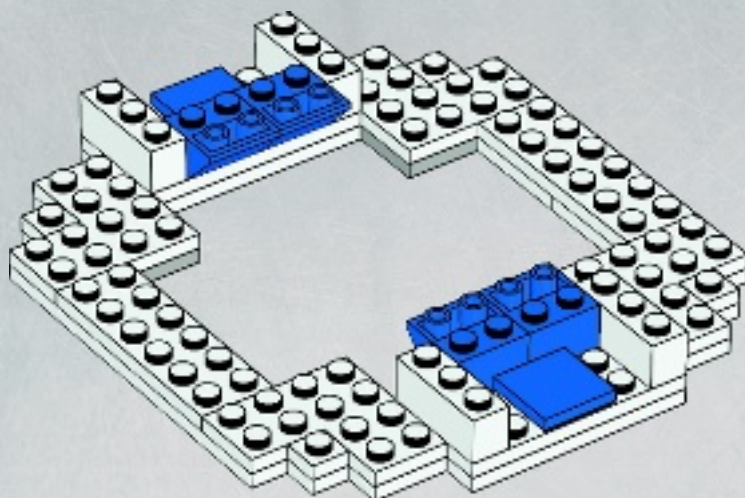

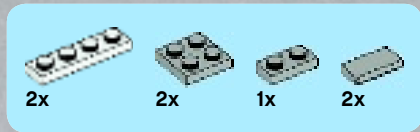

5

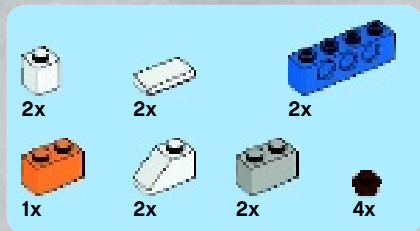
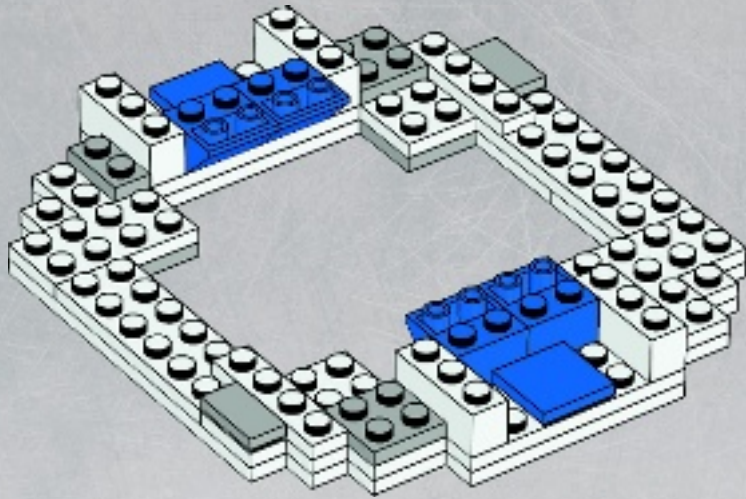

6

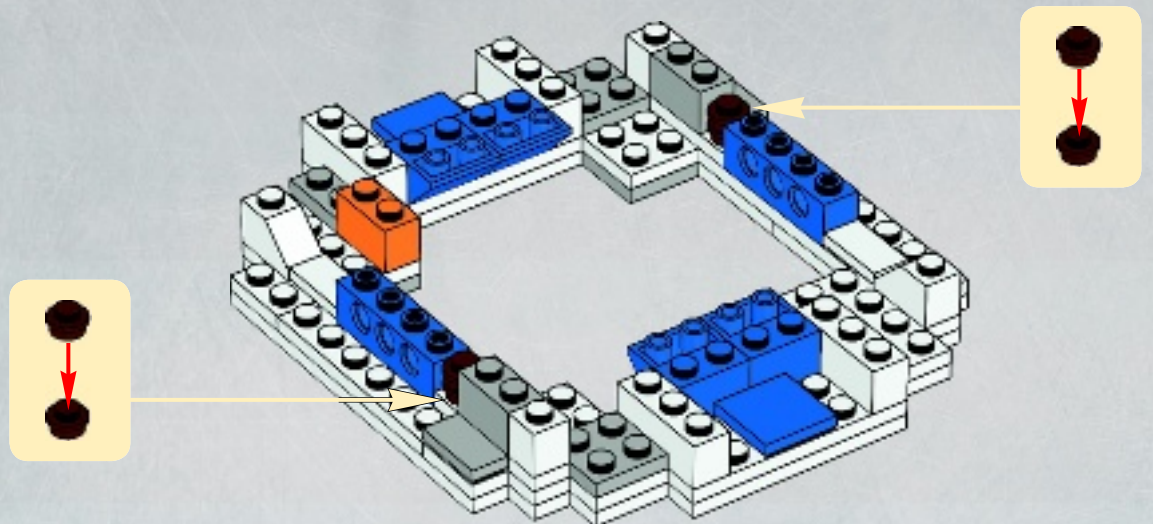



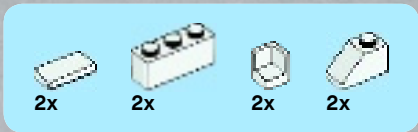

7

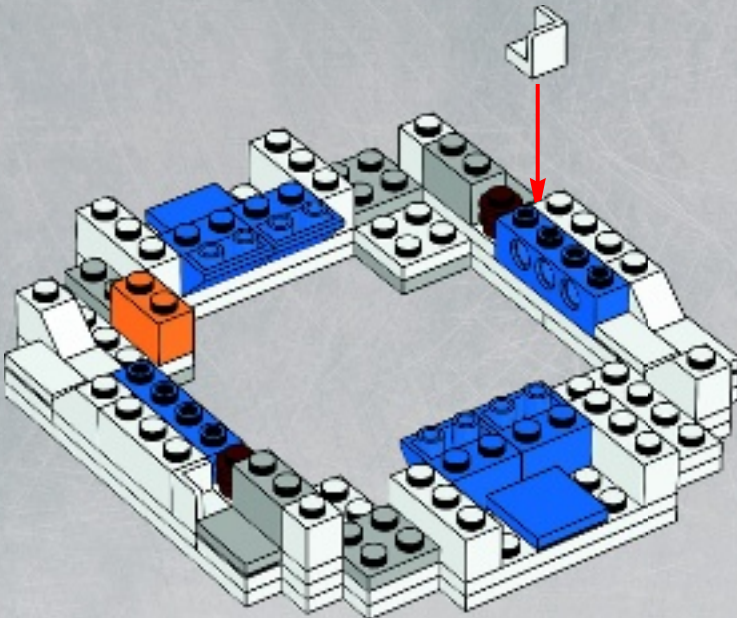

8

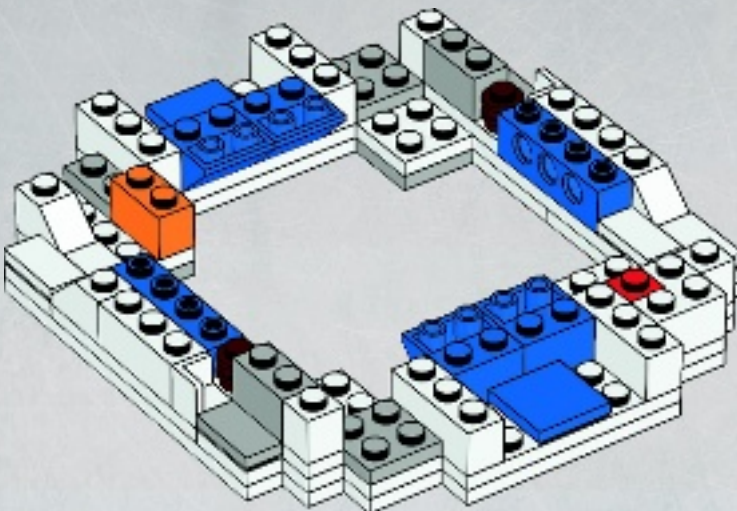



9

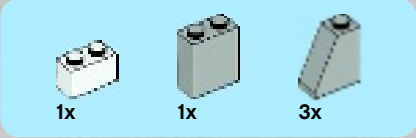
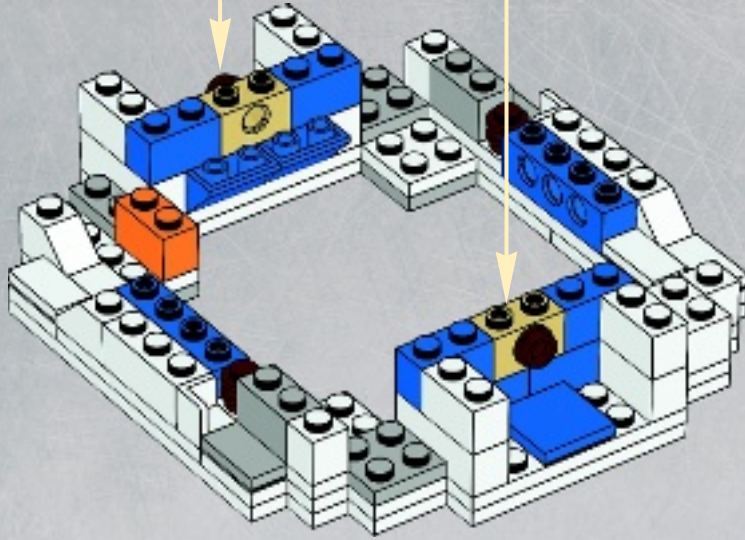
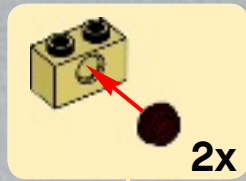

10

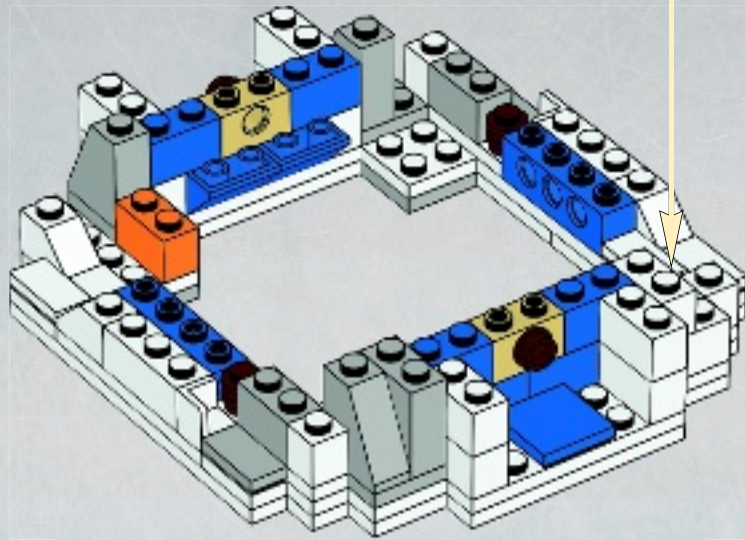



# 11

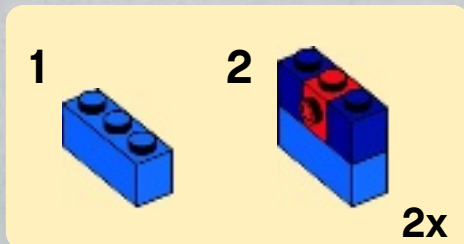
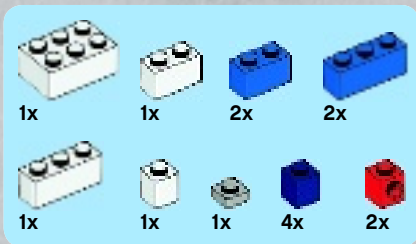
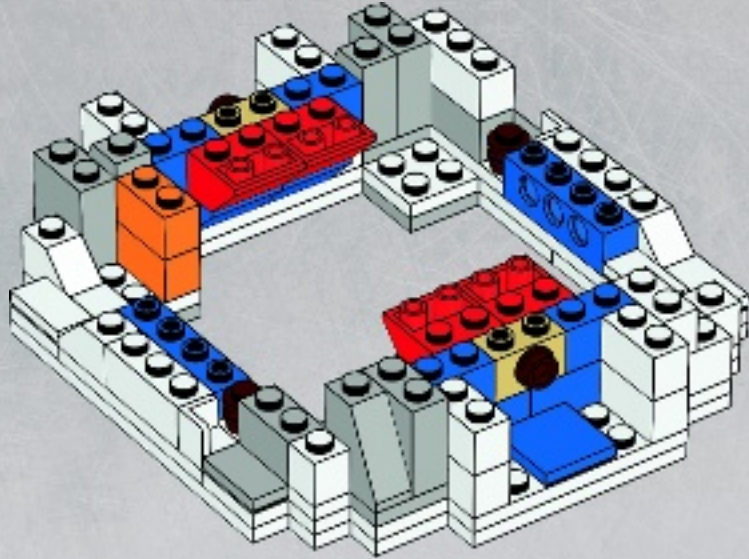

# 12

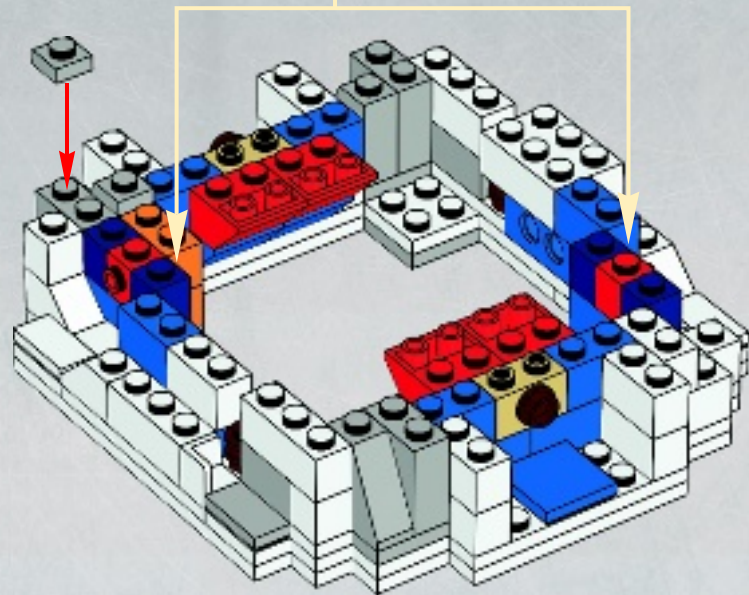



# 13

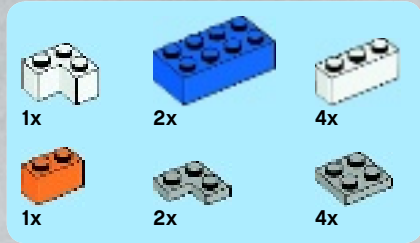
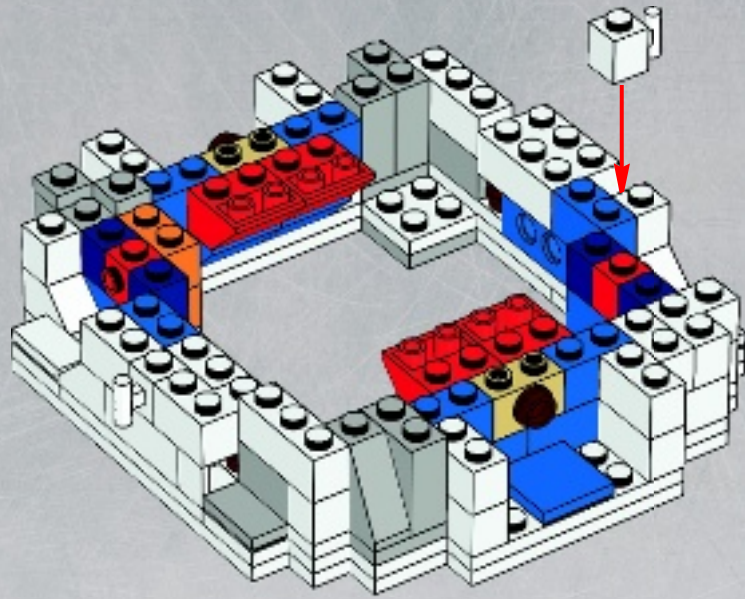

# 14

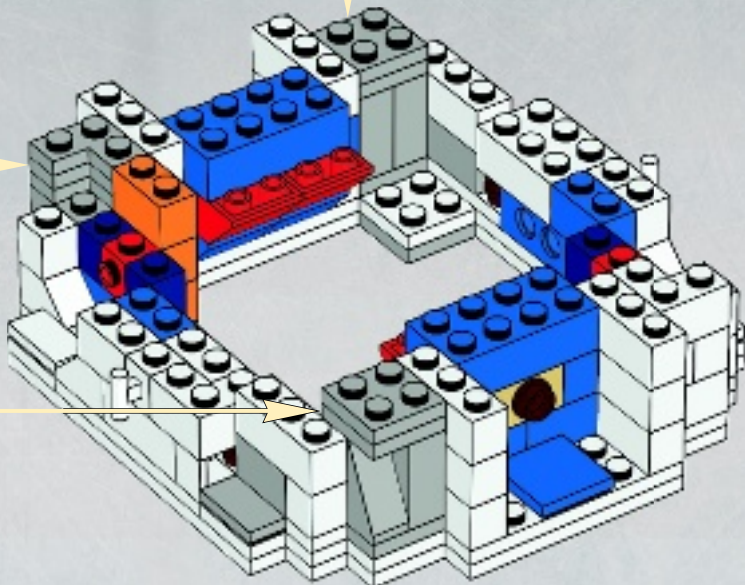
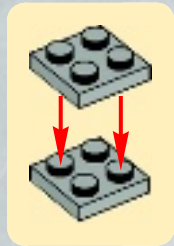
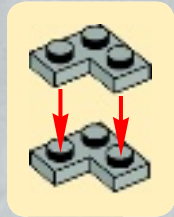
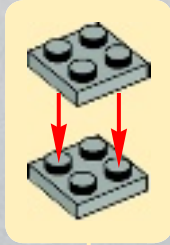



2x



2x

# 15

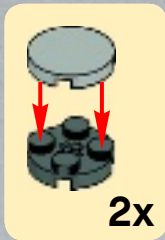

2x

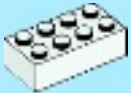
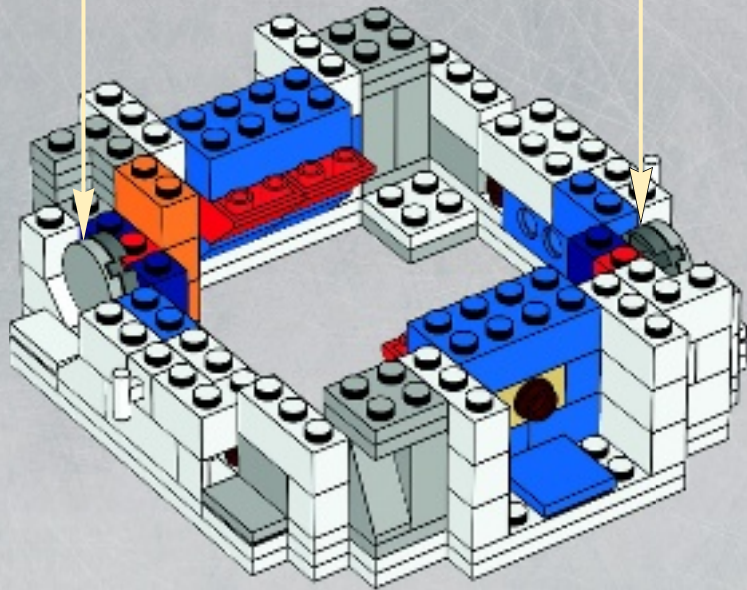

2x



2x



2x



2x



2x

# 16

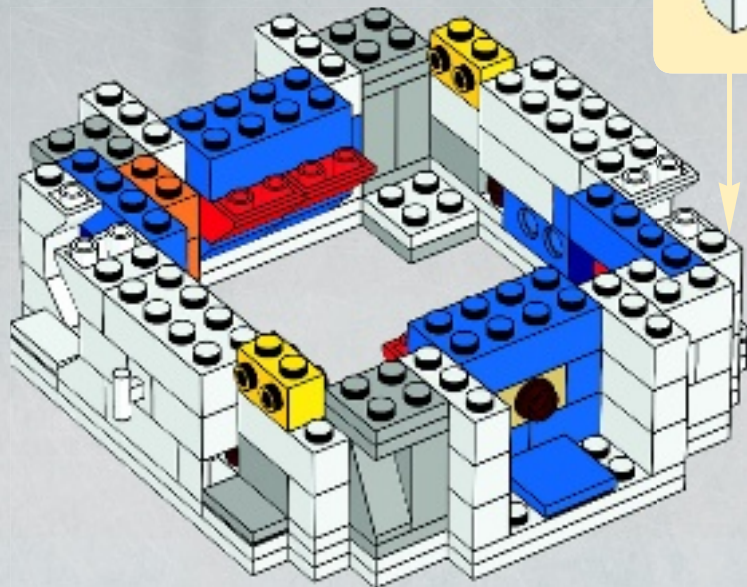

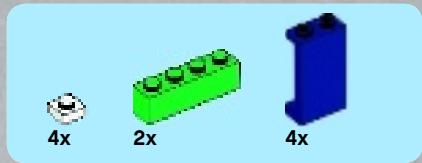

17

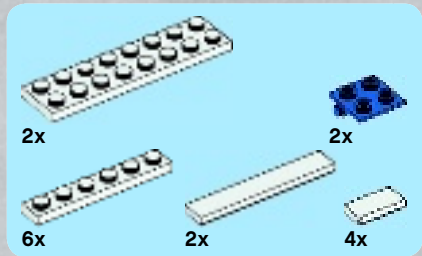
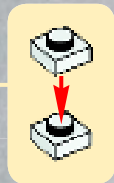
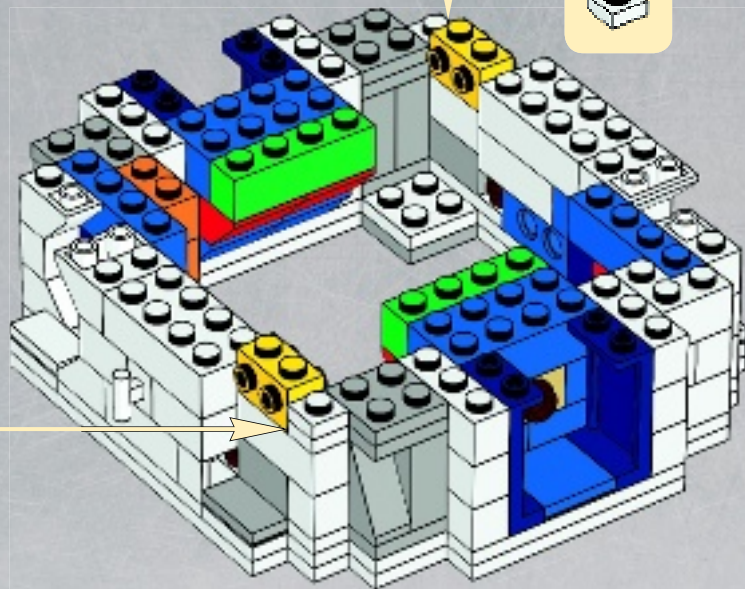
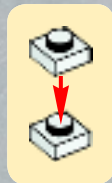

18

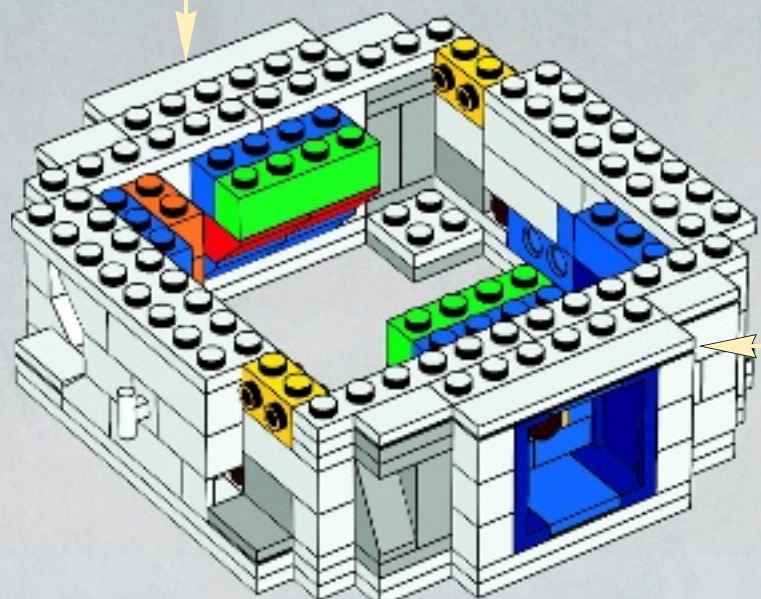
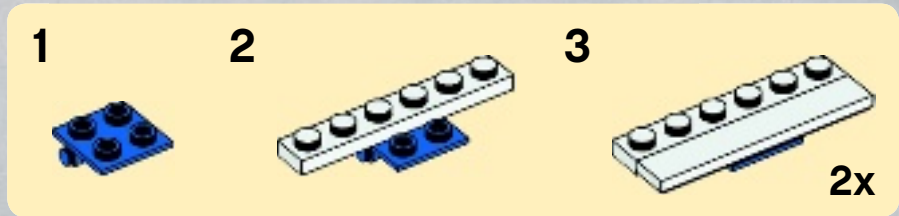

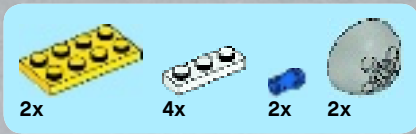

# 19

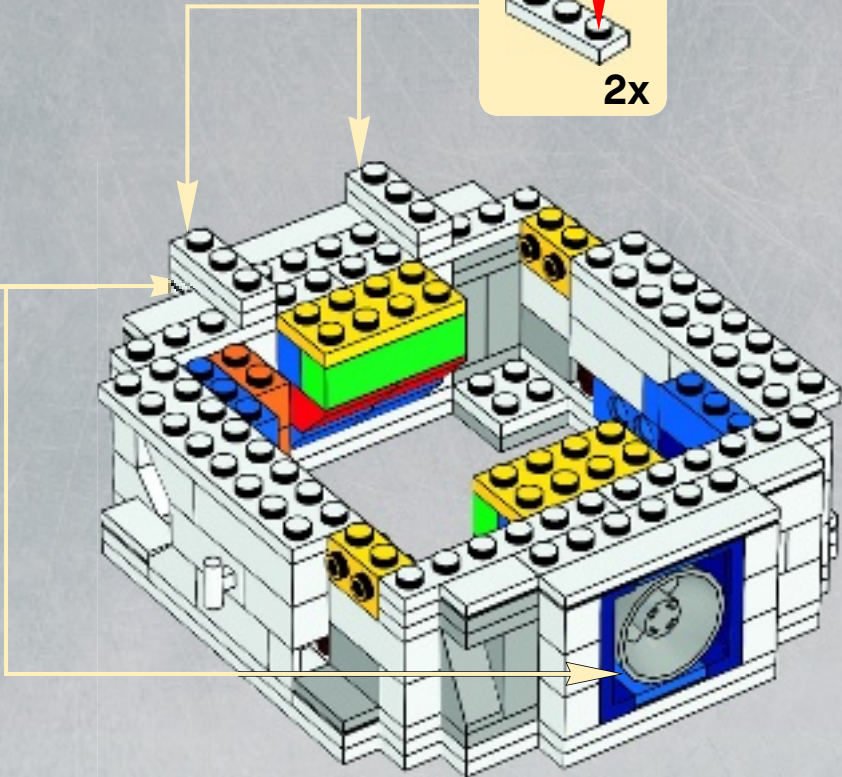
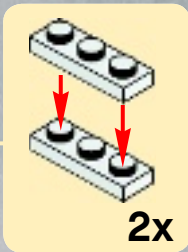
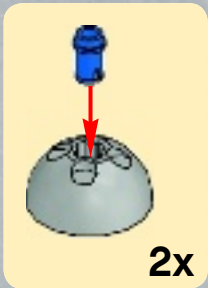

# 20

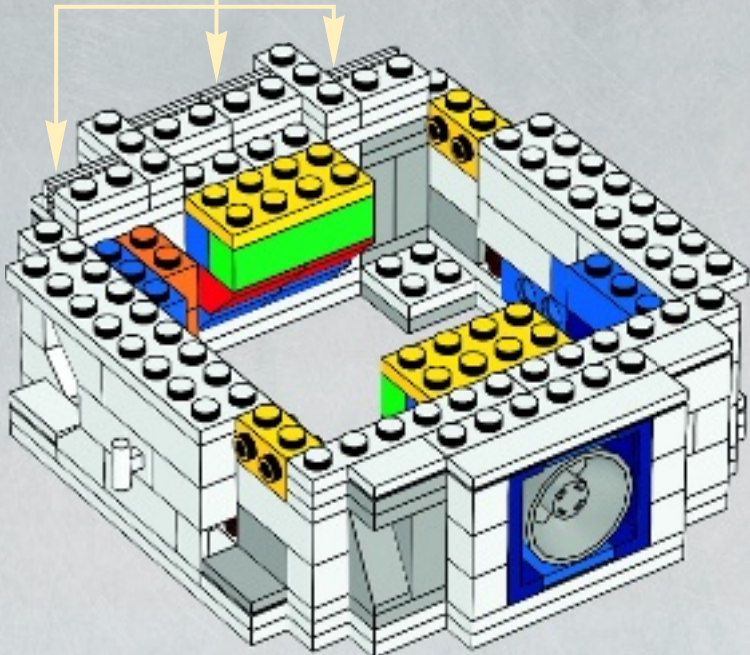
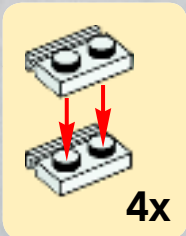

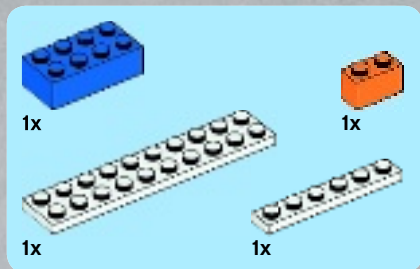

# 21

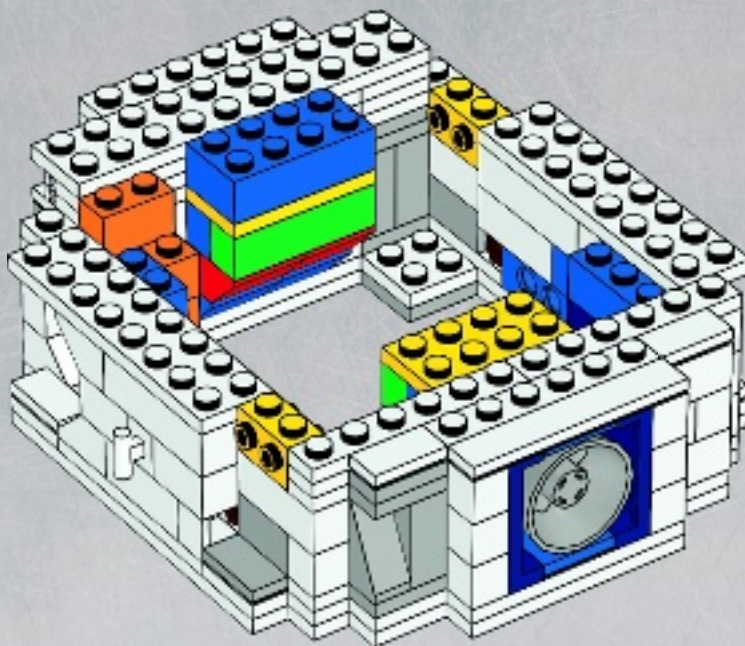

# 22

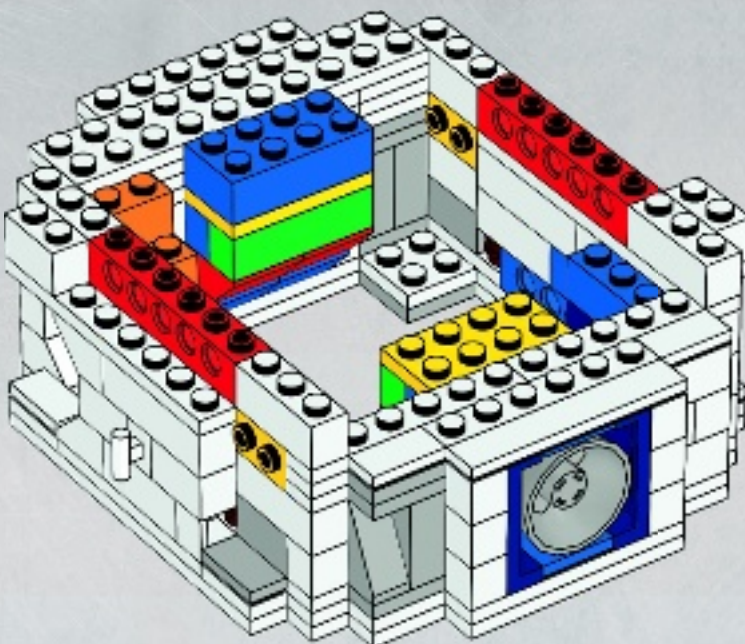



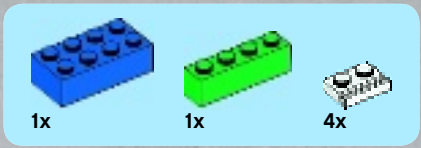

# 23

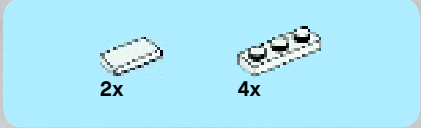
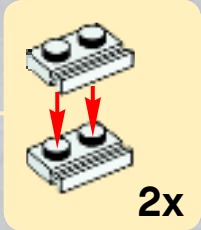
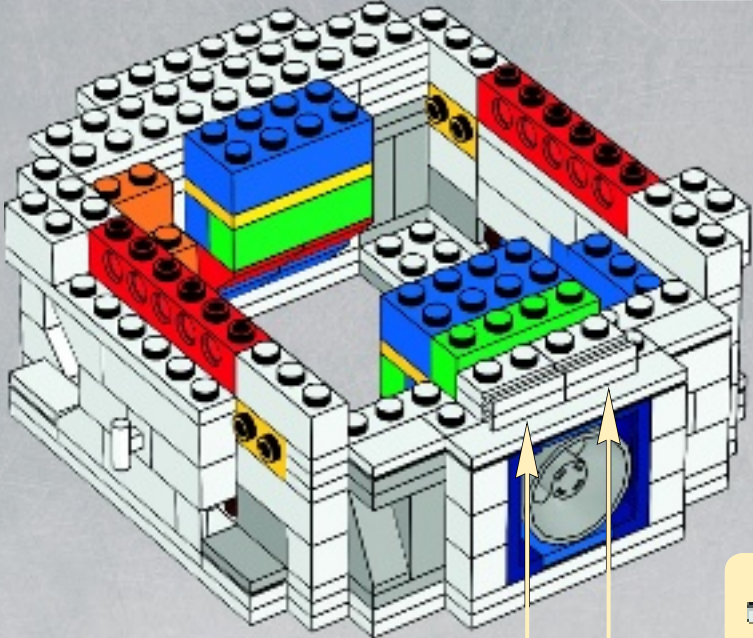

# 24

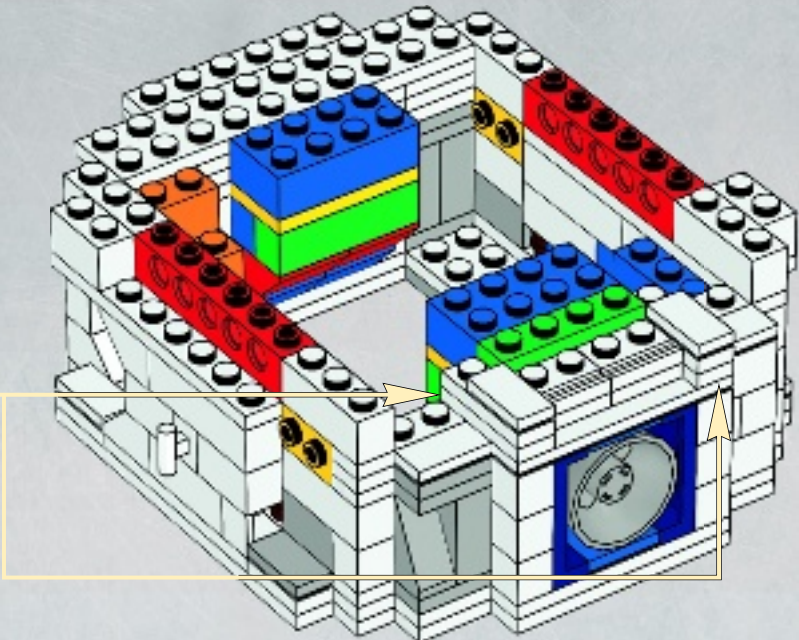
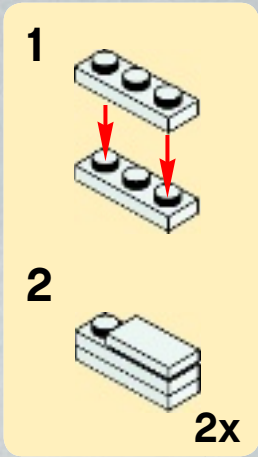



2x



4x

# 25

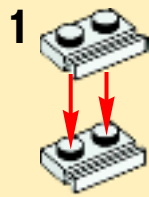

1

2

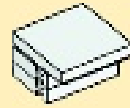

2x

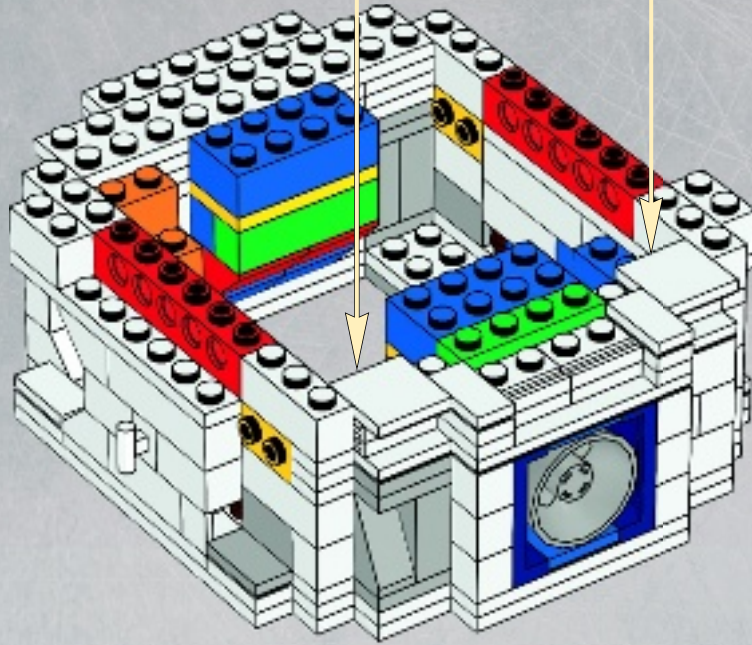

8x



4x

# 26

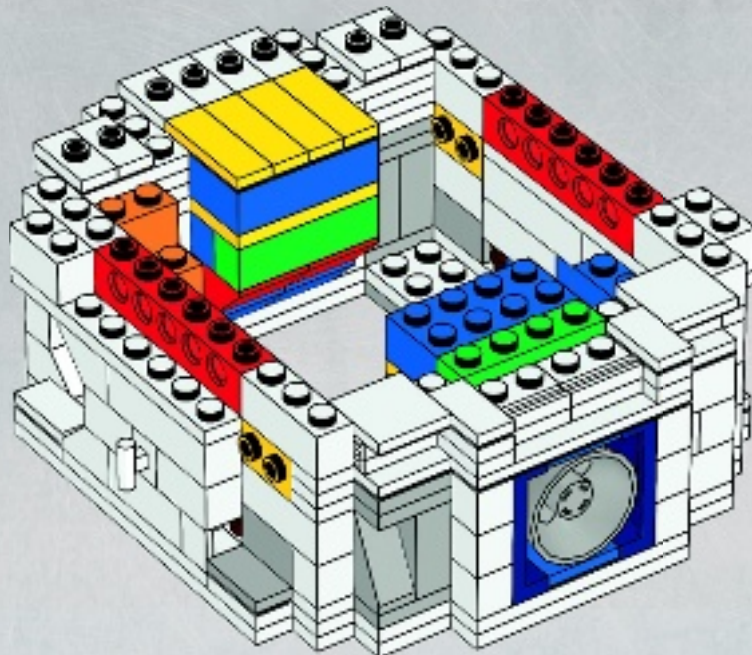



4x



2x



2x



1x

# 27

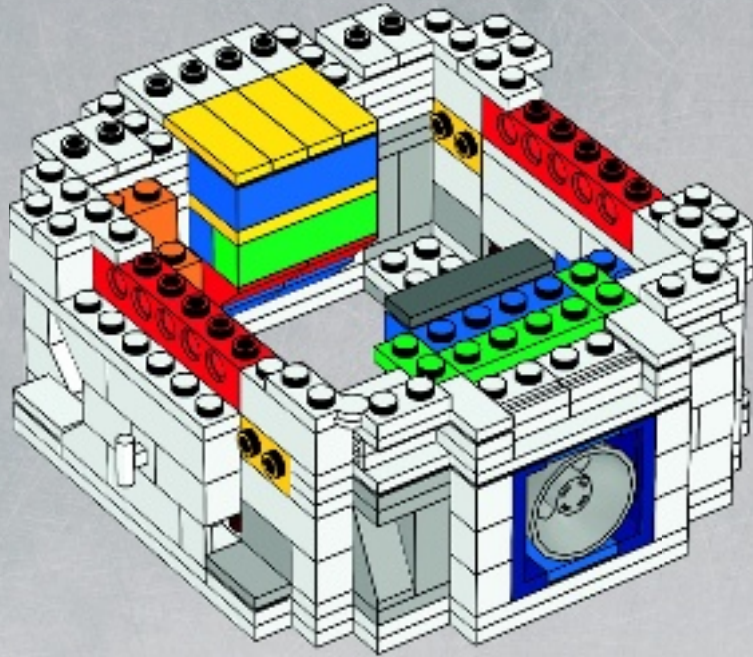

4x



2x



1x



1x



1x

# 28

1

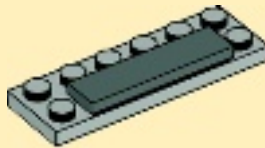

2

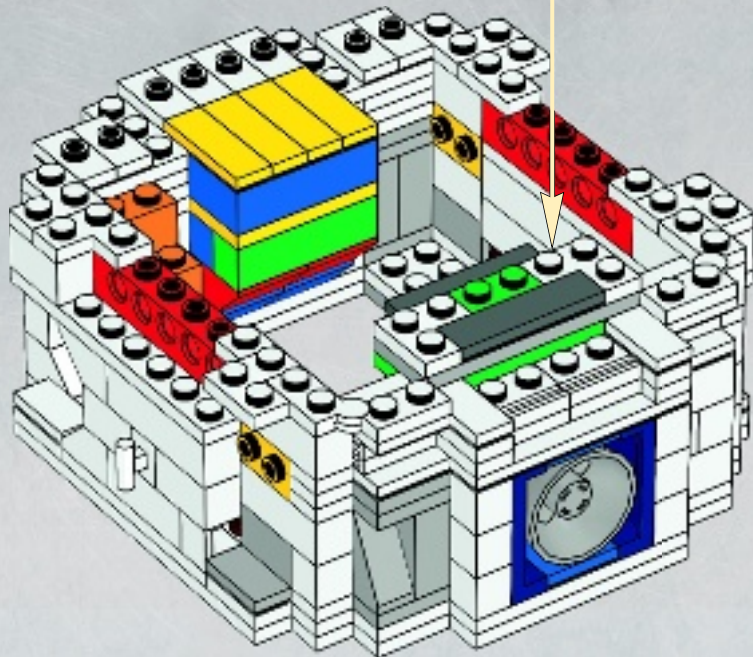
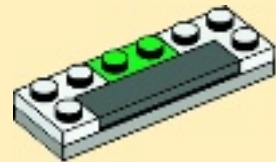



# 29

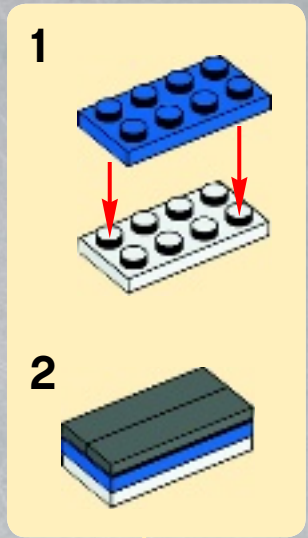
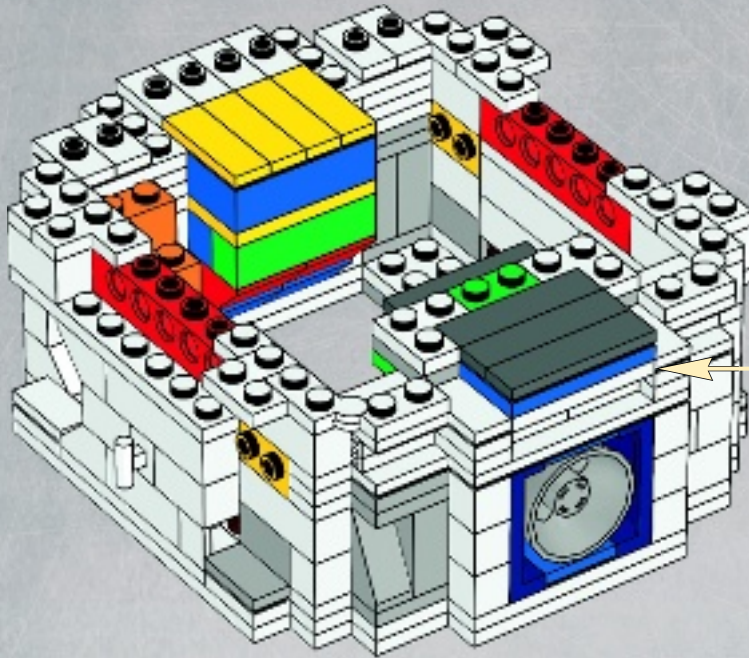

# 30

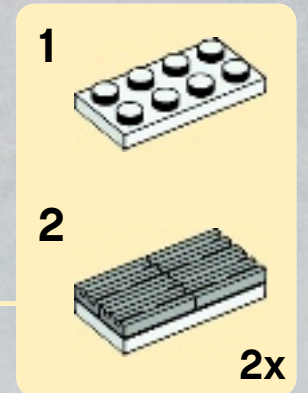
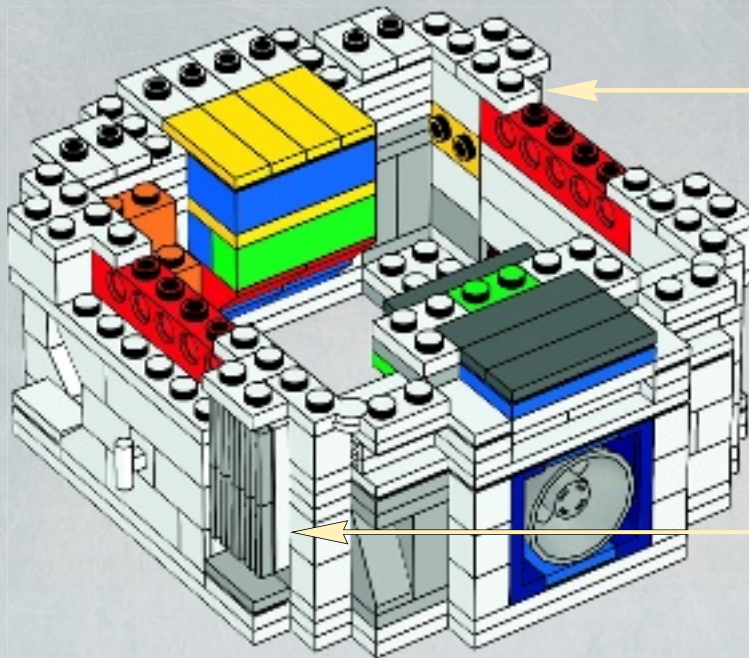

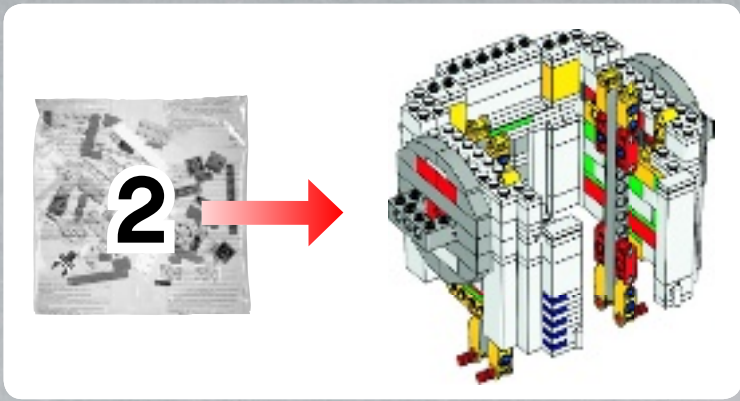

31

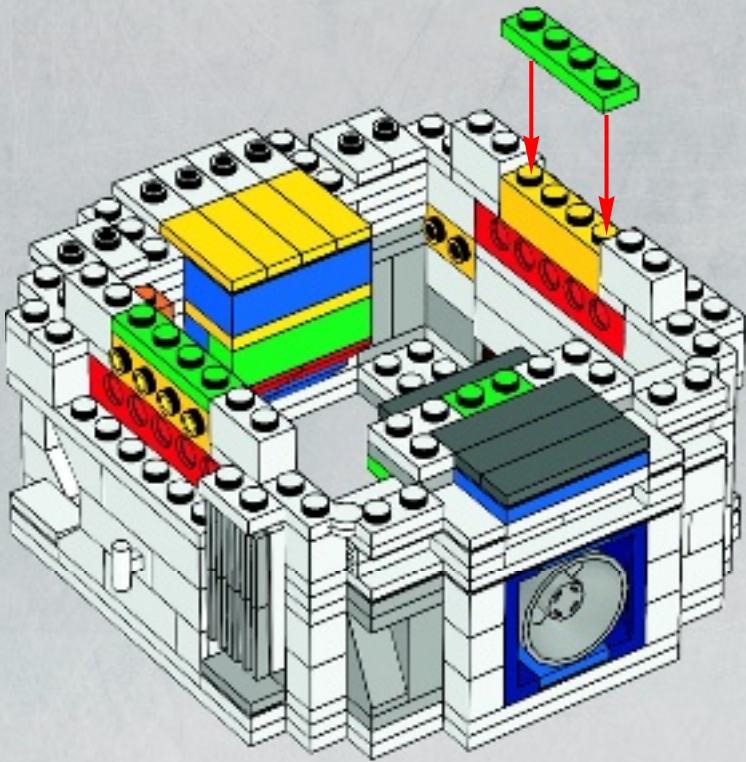

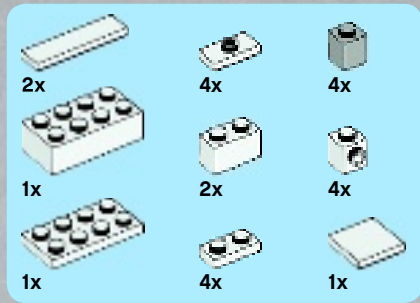

# 32

1

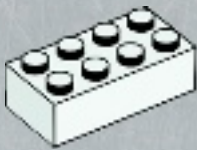

2

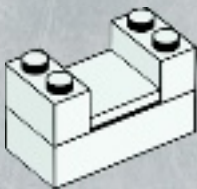

3

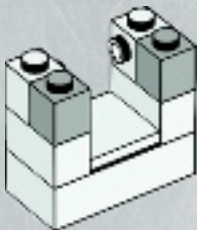

4

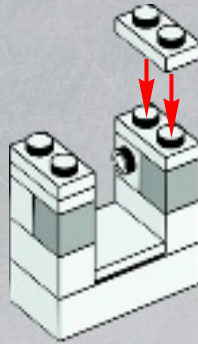

5

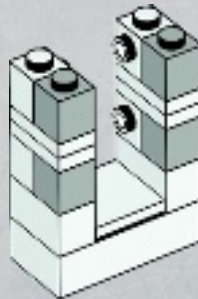

7

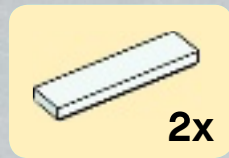
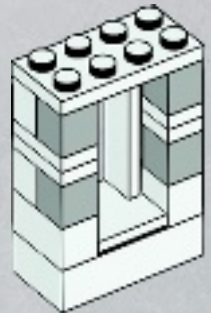

6

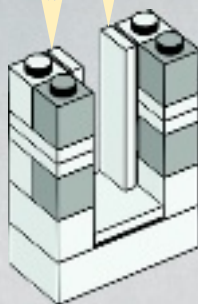

8

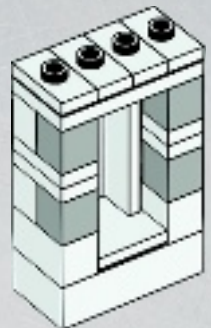

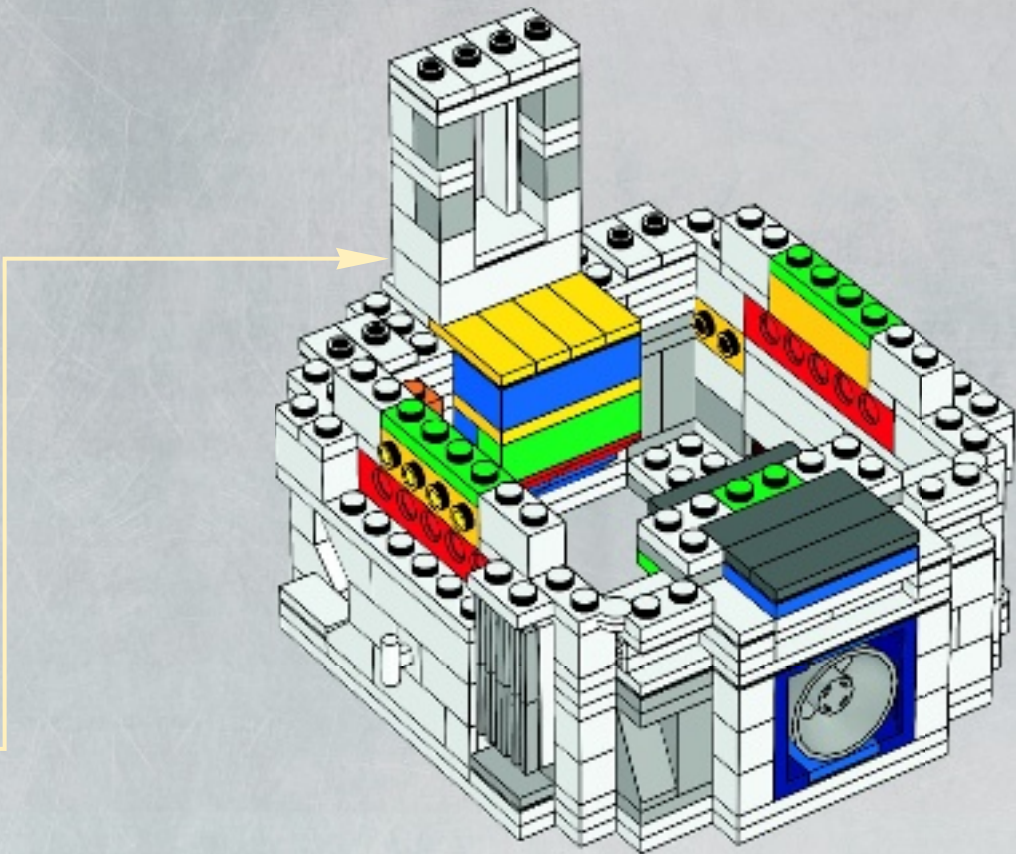

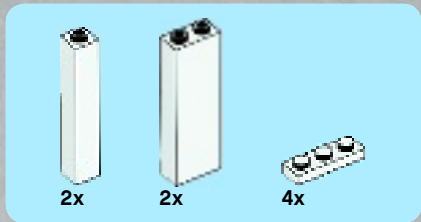

# 33

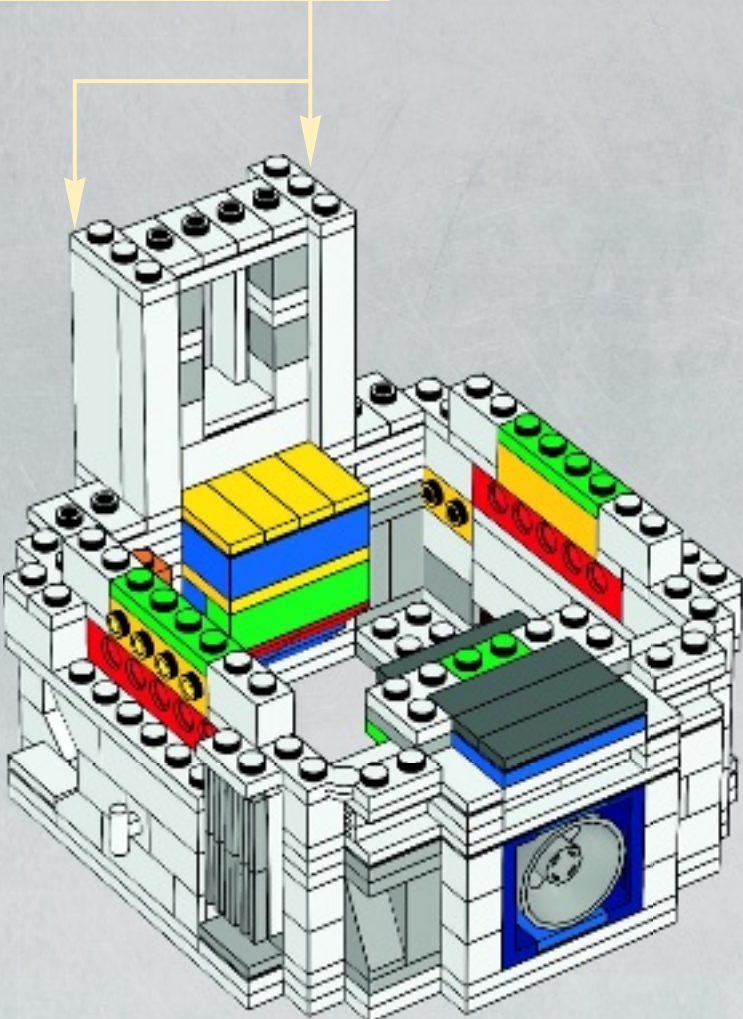
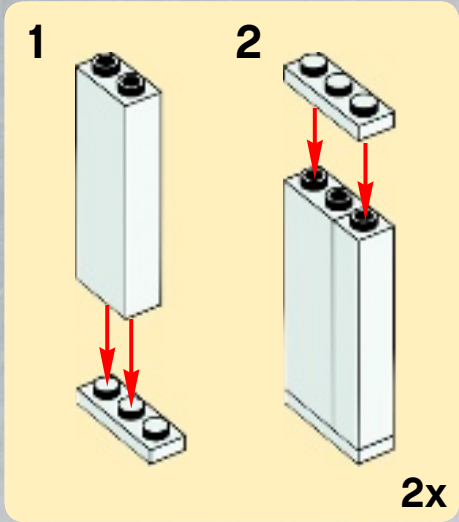



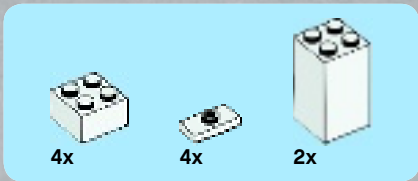

# 34

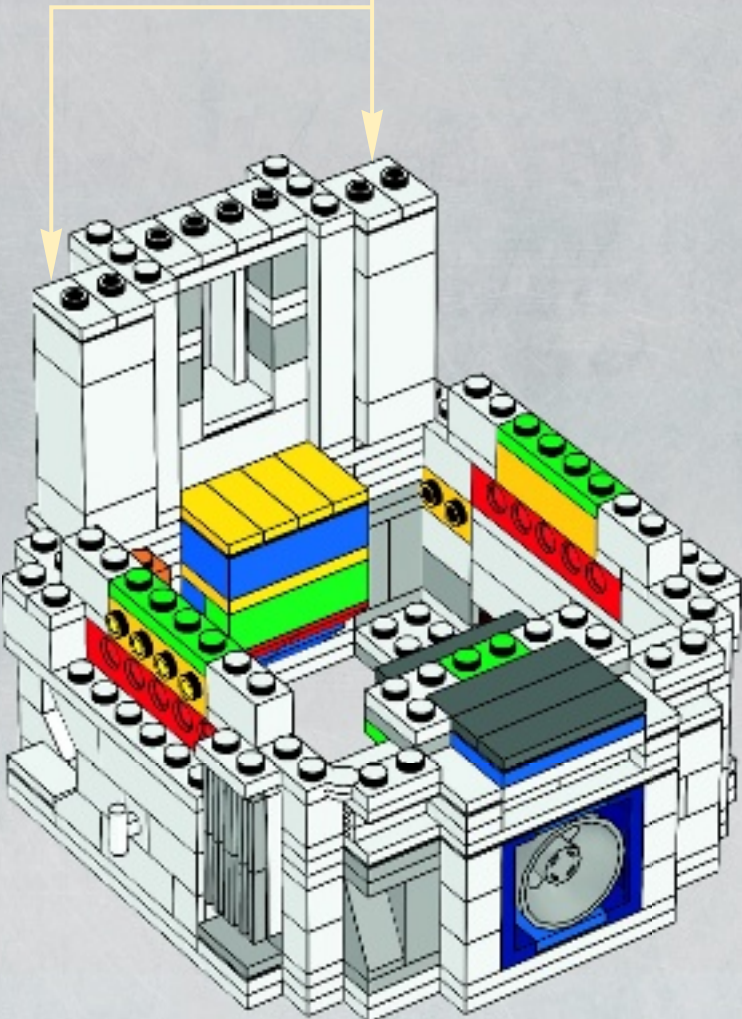
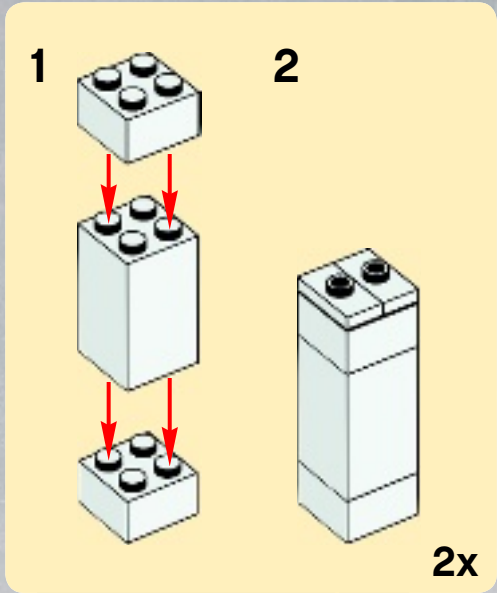

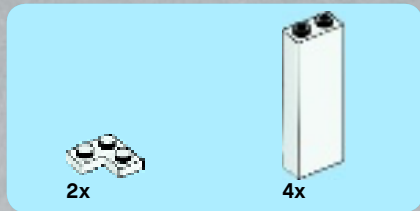

# 35

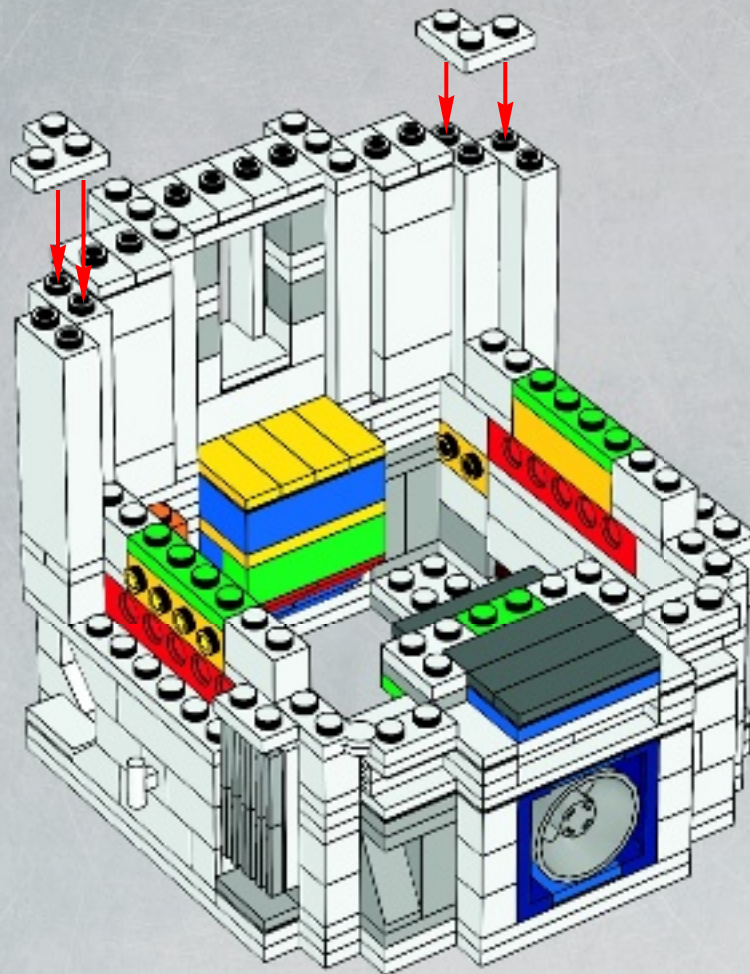

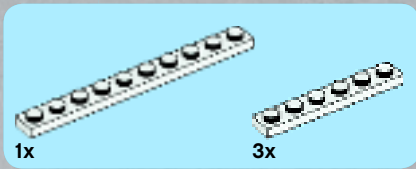

# 36

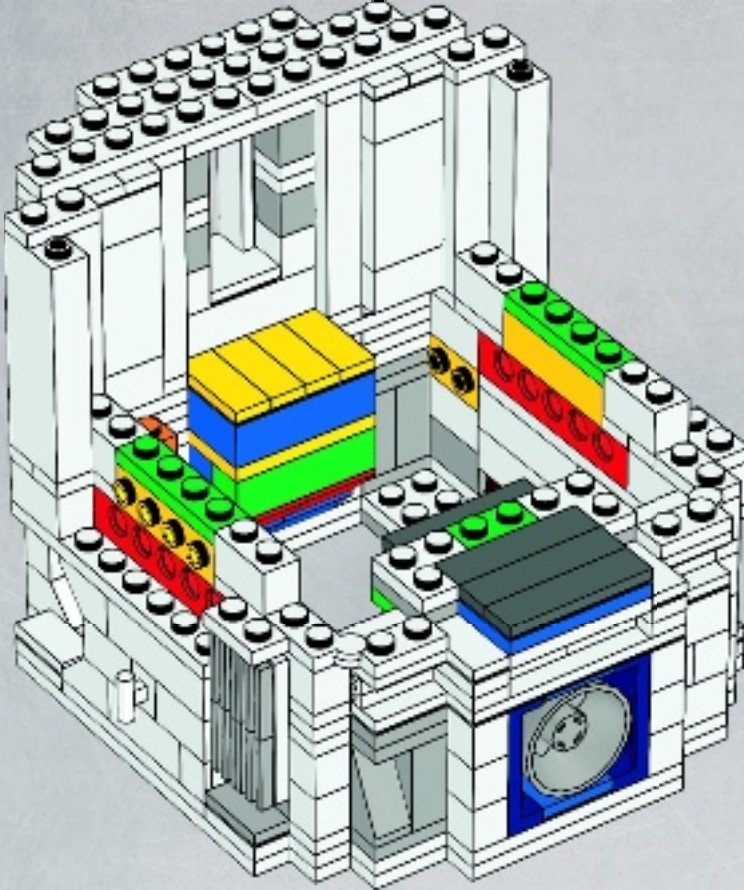

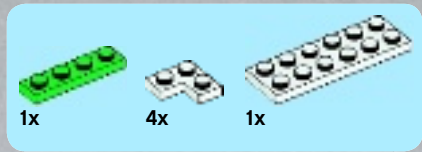

# 37

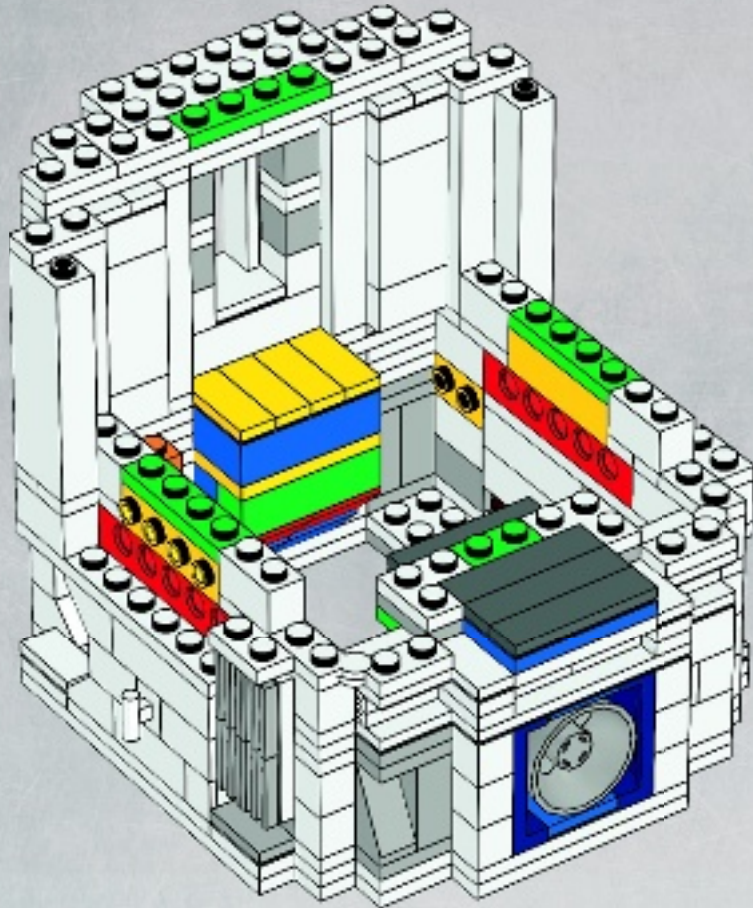

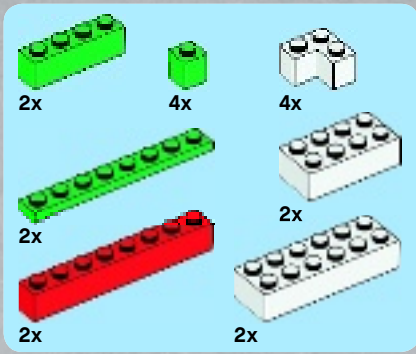

# 38

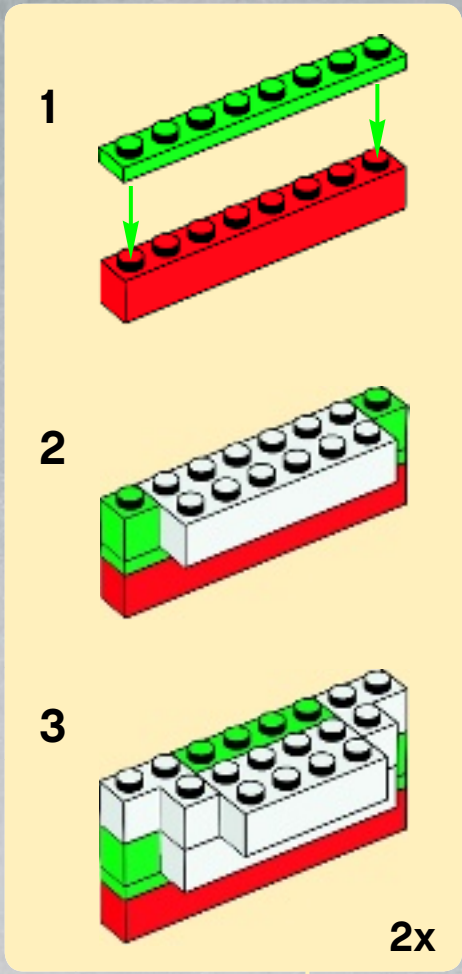
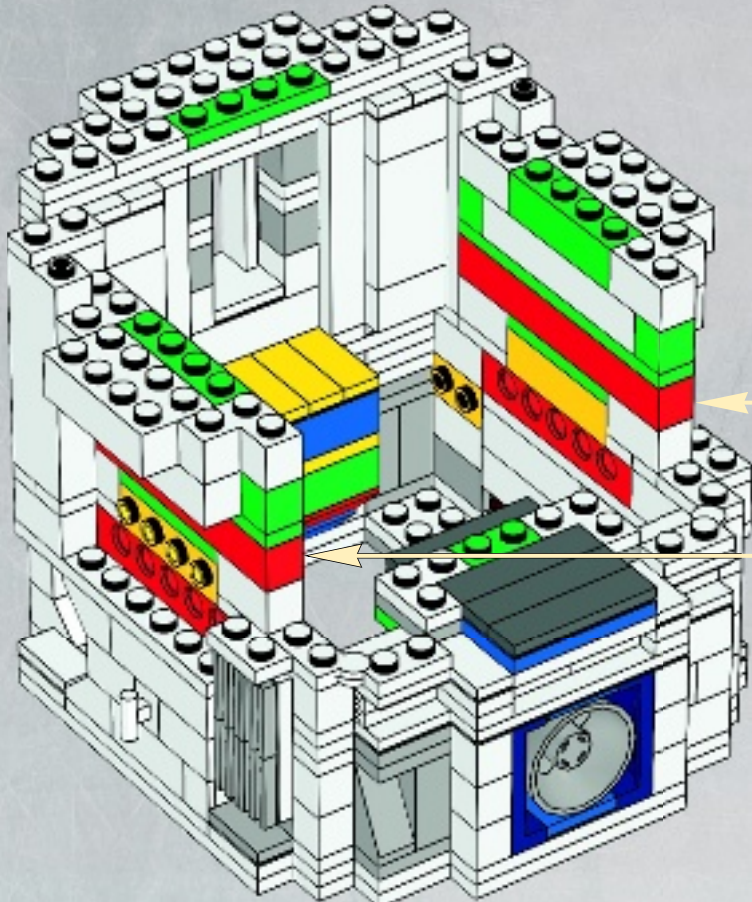



4x

39

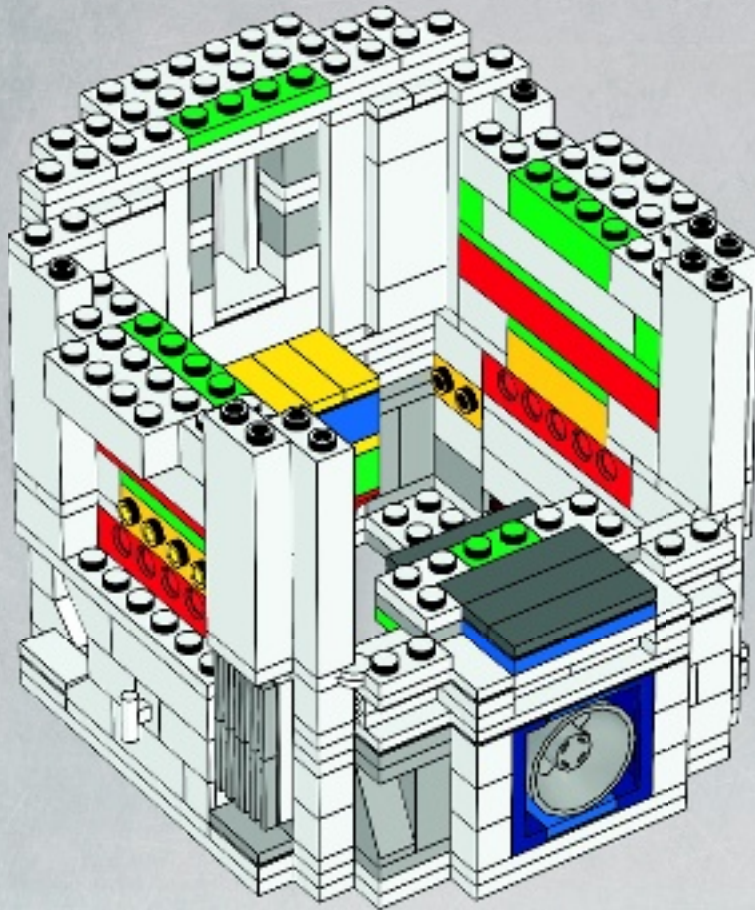

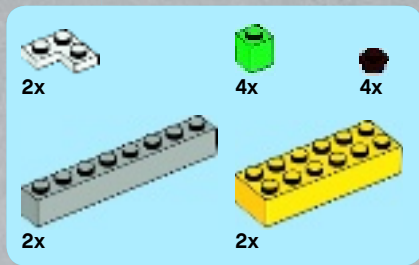

40

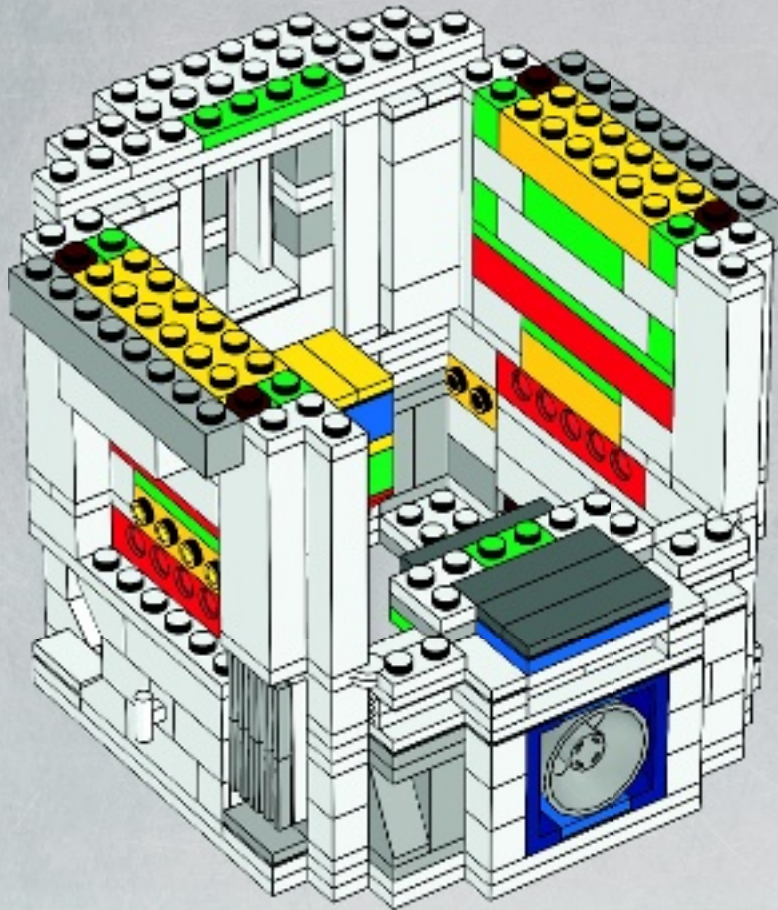



4x



4x

# 41

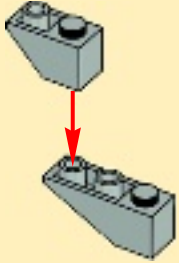

2x

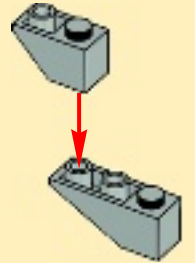

2x

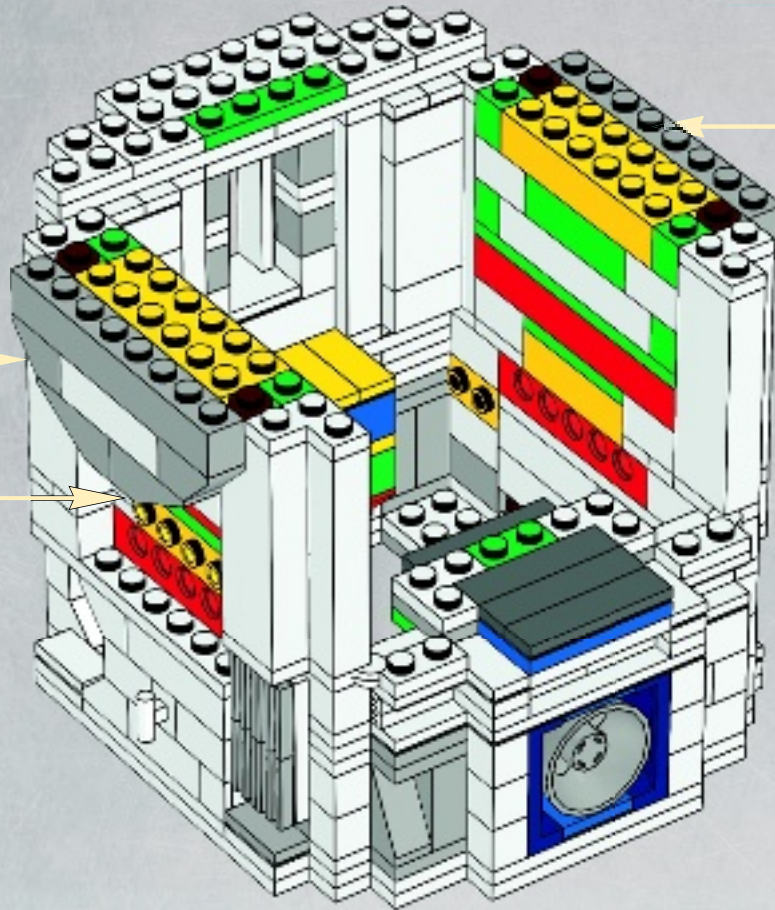



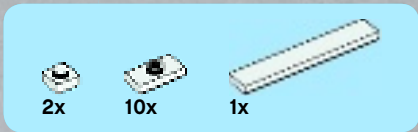

42

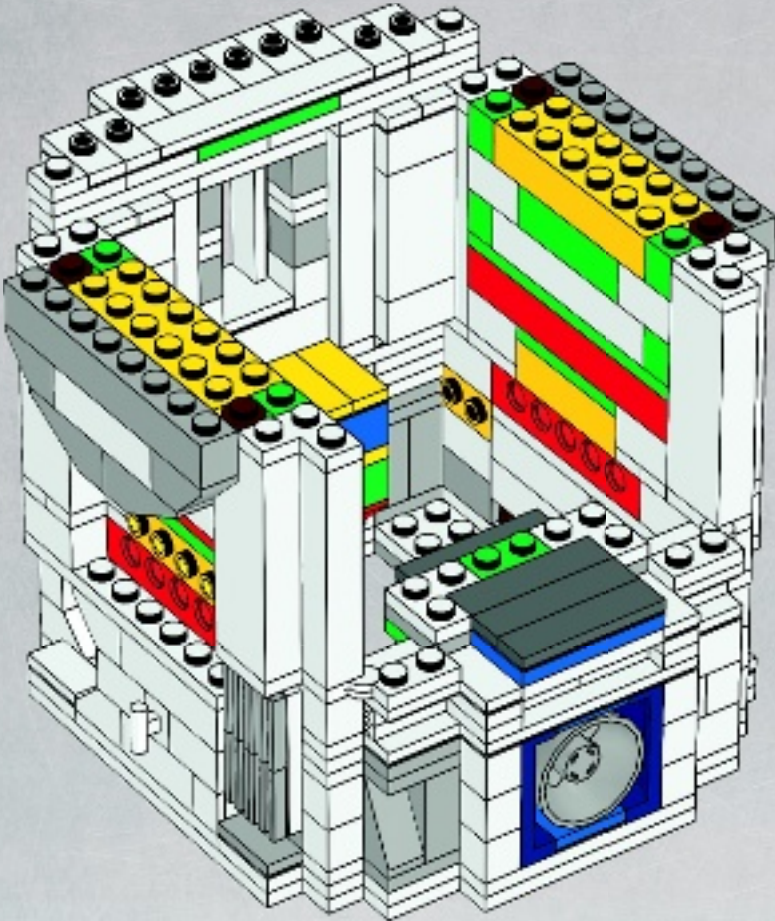

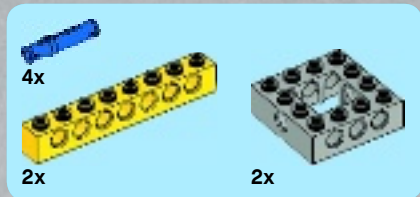

# 43

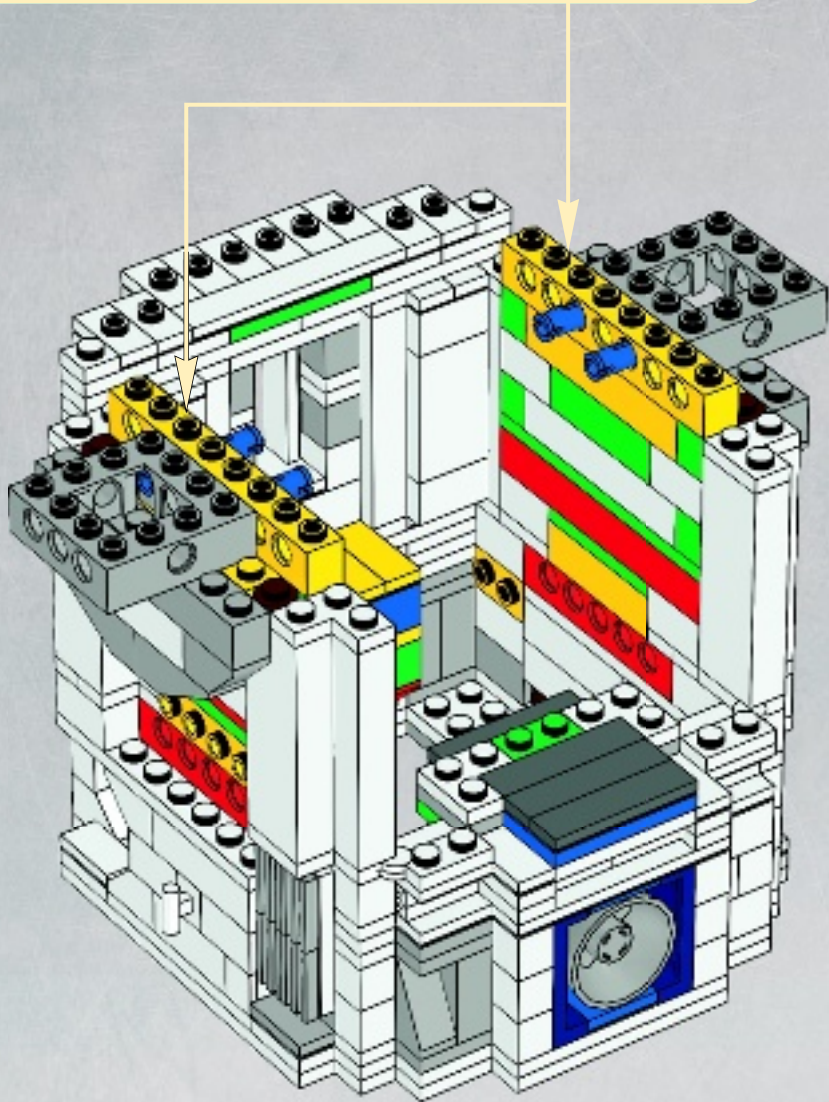
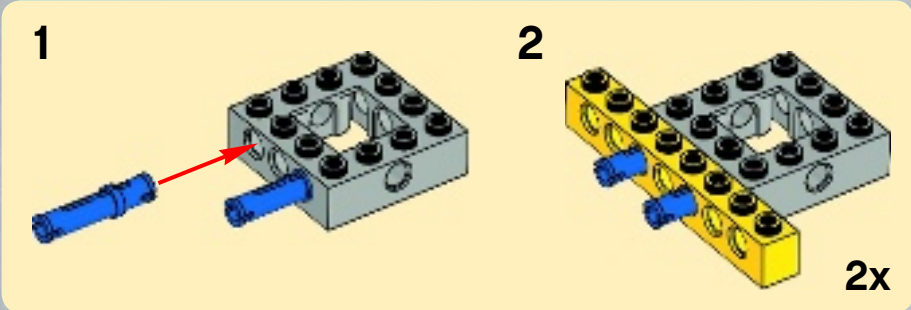



2x



4x



4x



2x

# 44

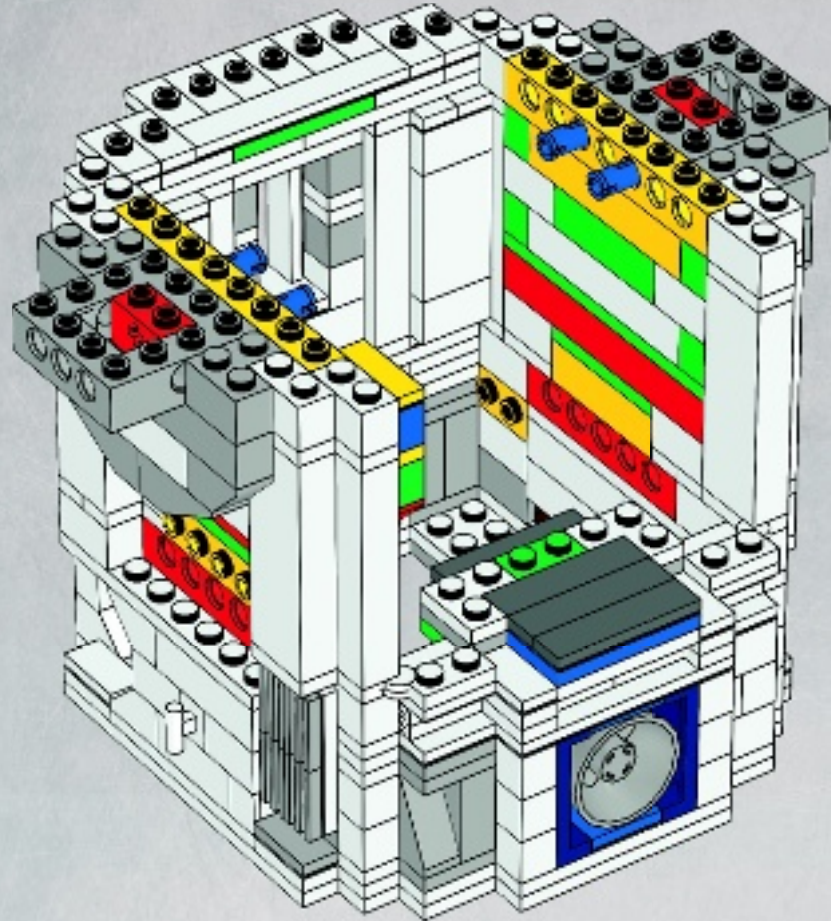



1x



2x

# 45

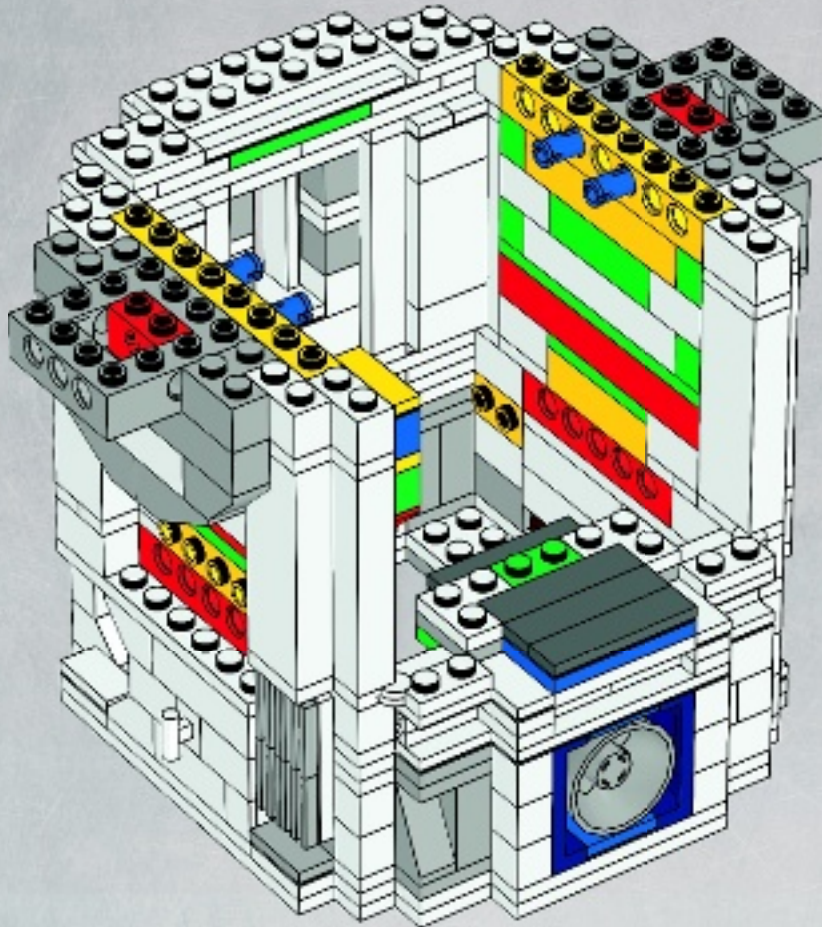

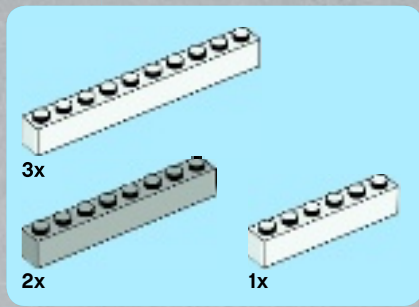

46

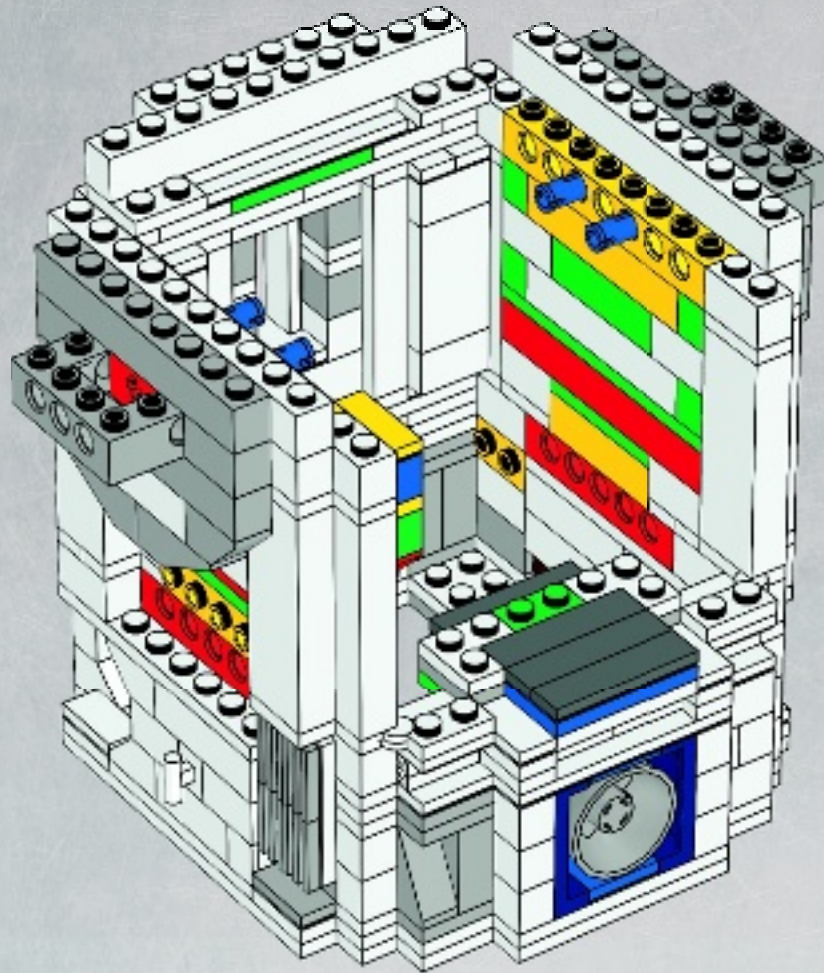

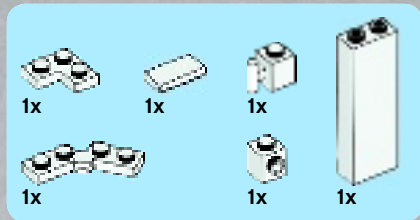

# 47

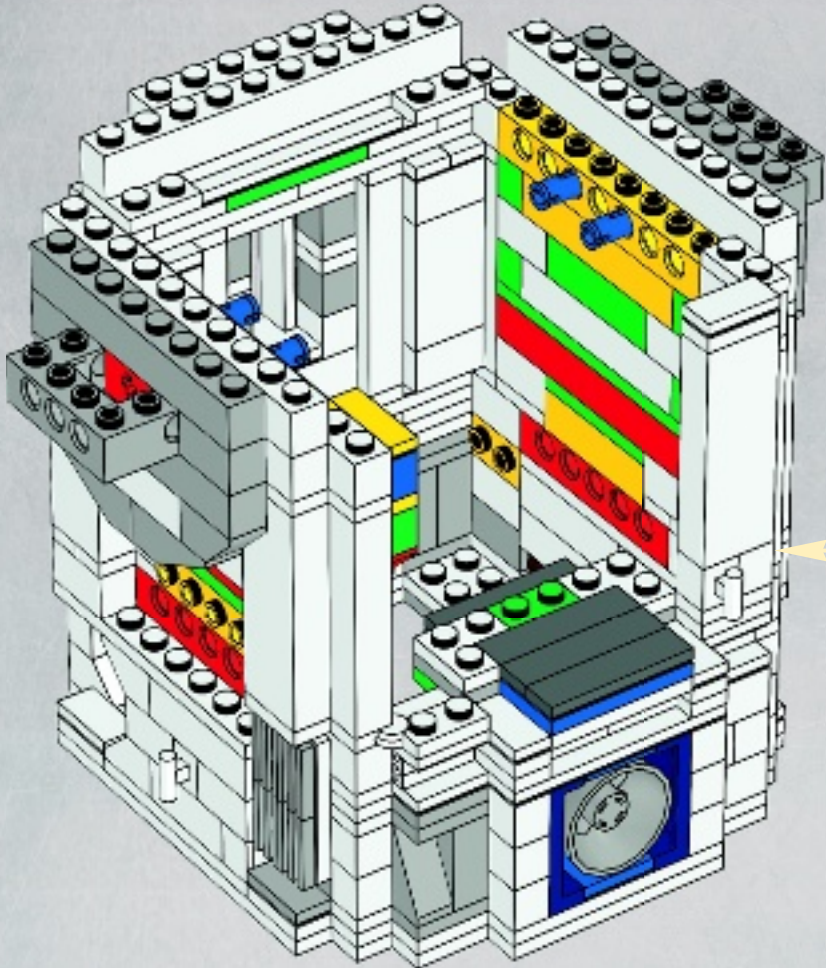
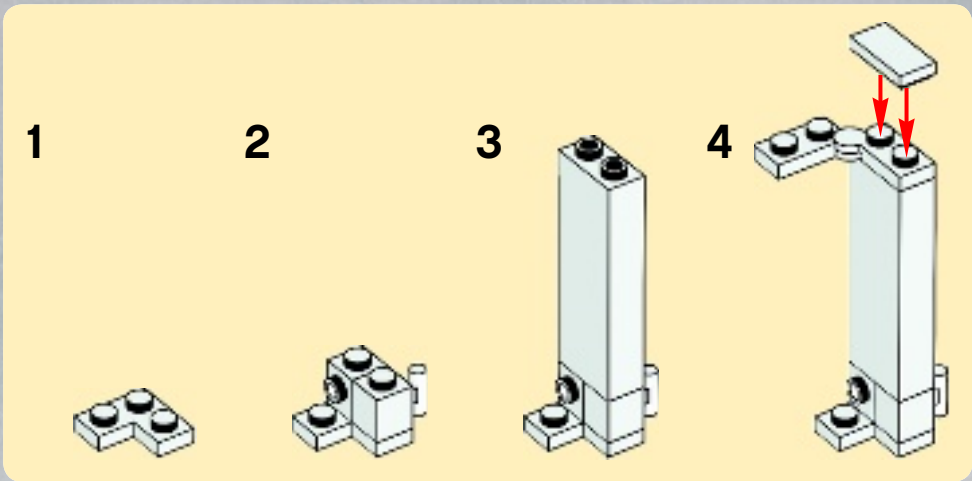

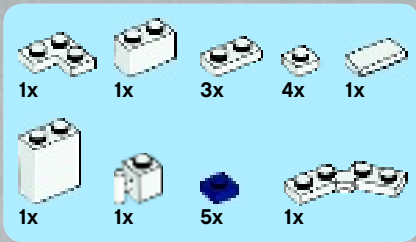

# 48

1



2



3



4

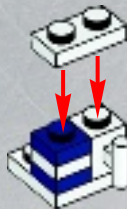

5

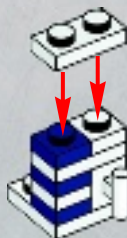

6

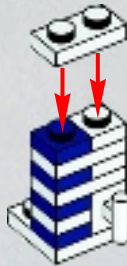

7



8

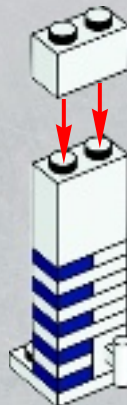

9



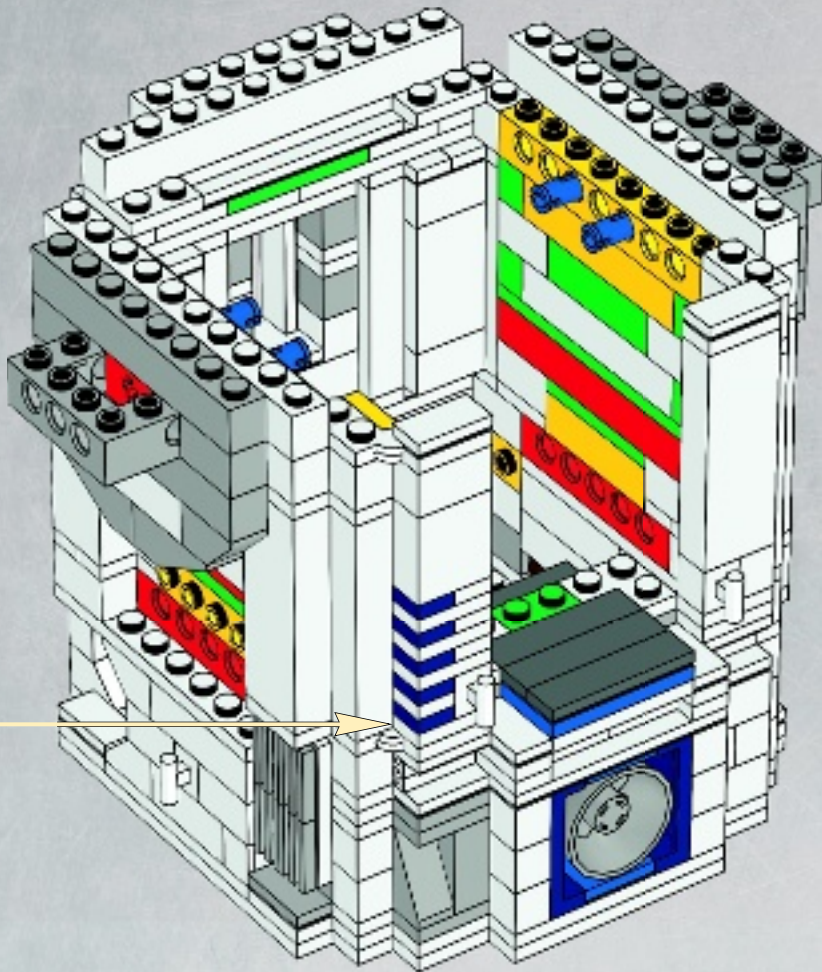





2x



2x

# 49

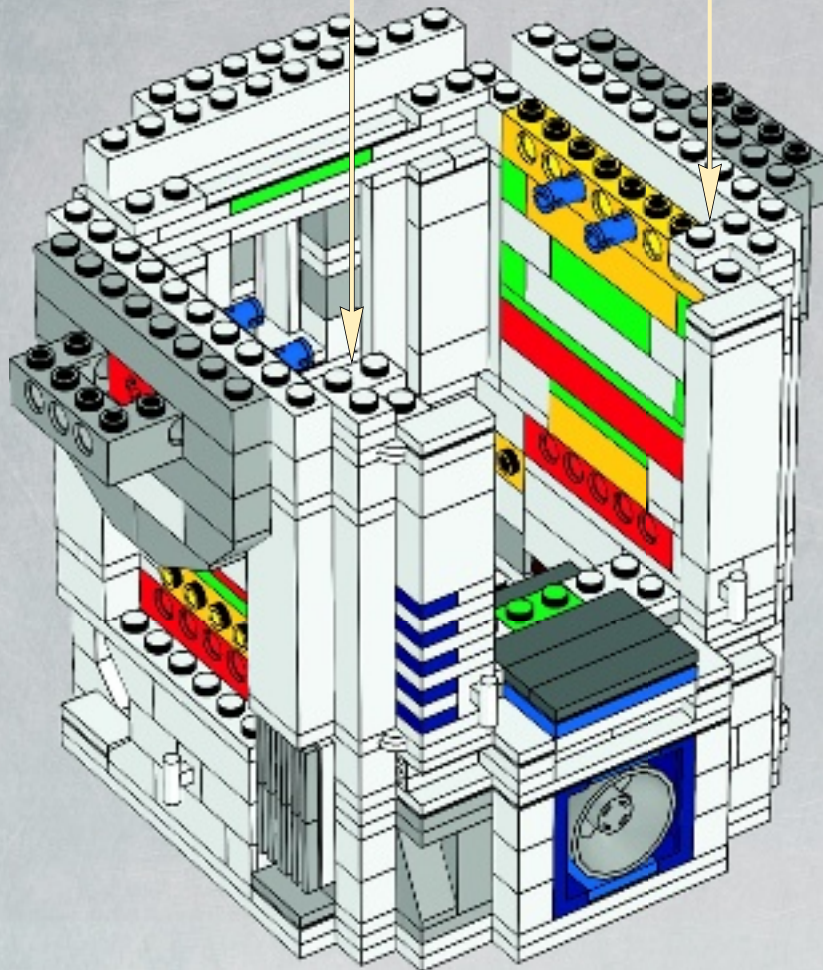
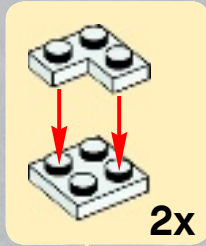

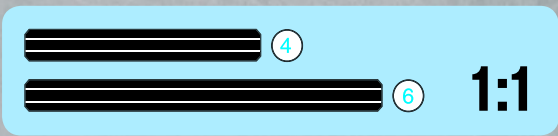
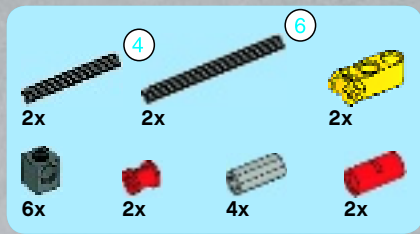

# 50

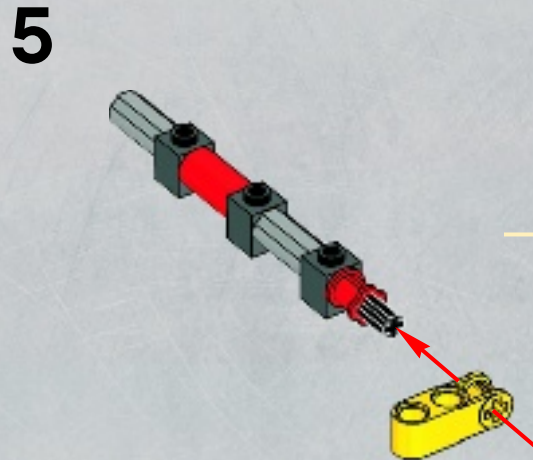
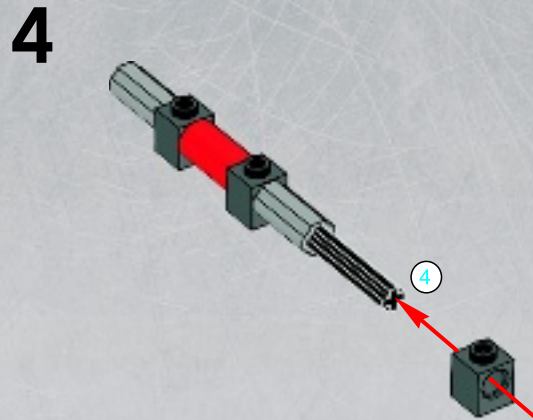
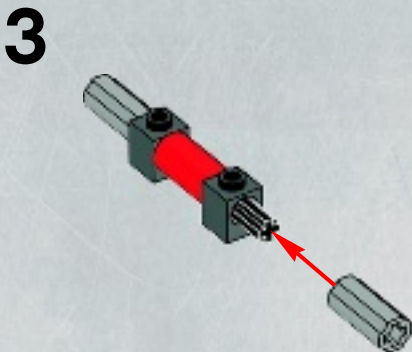
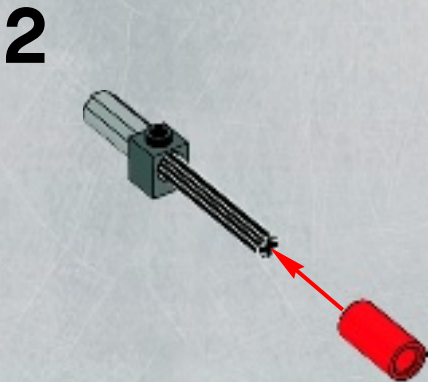
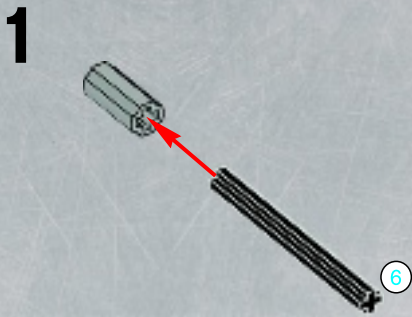

**2x**

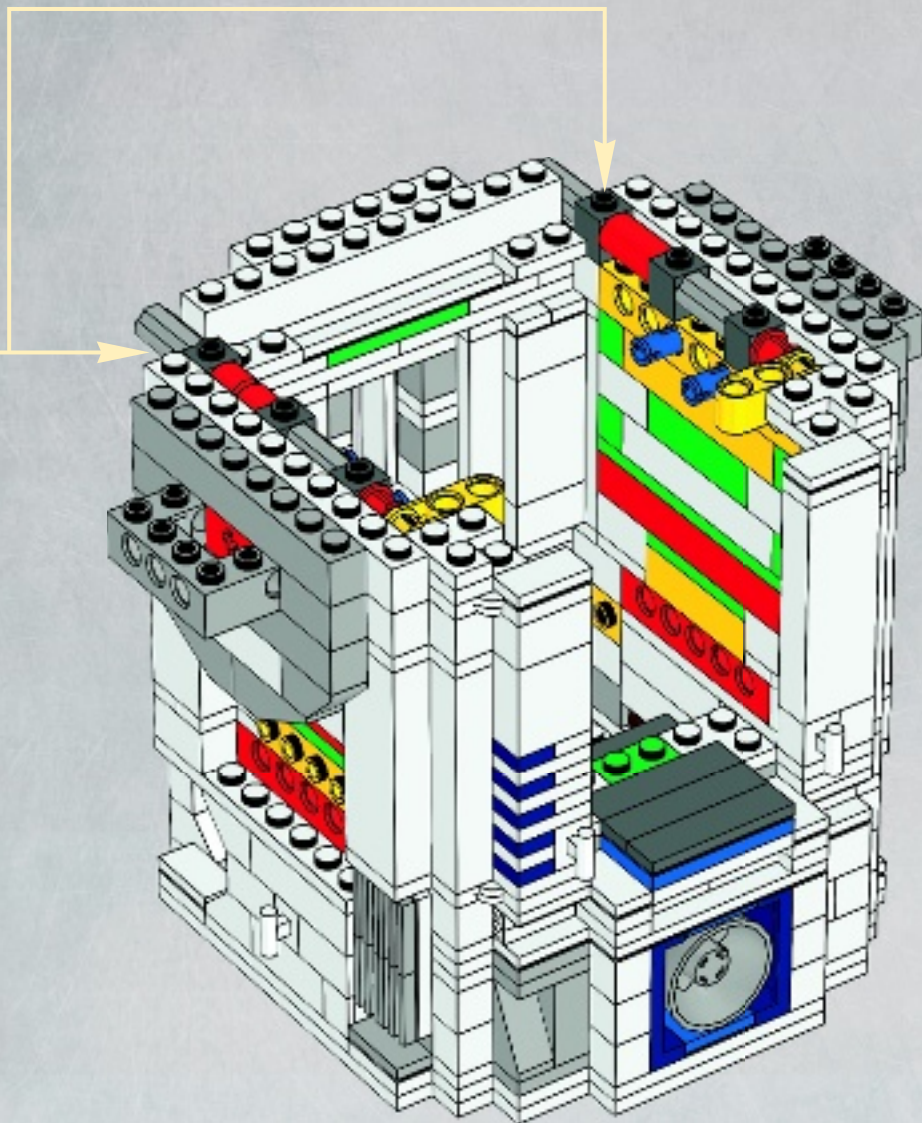



# 51

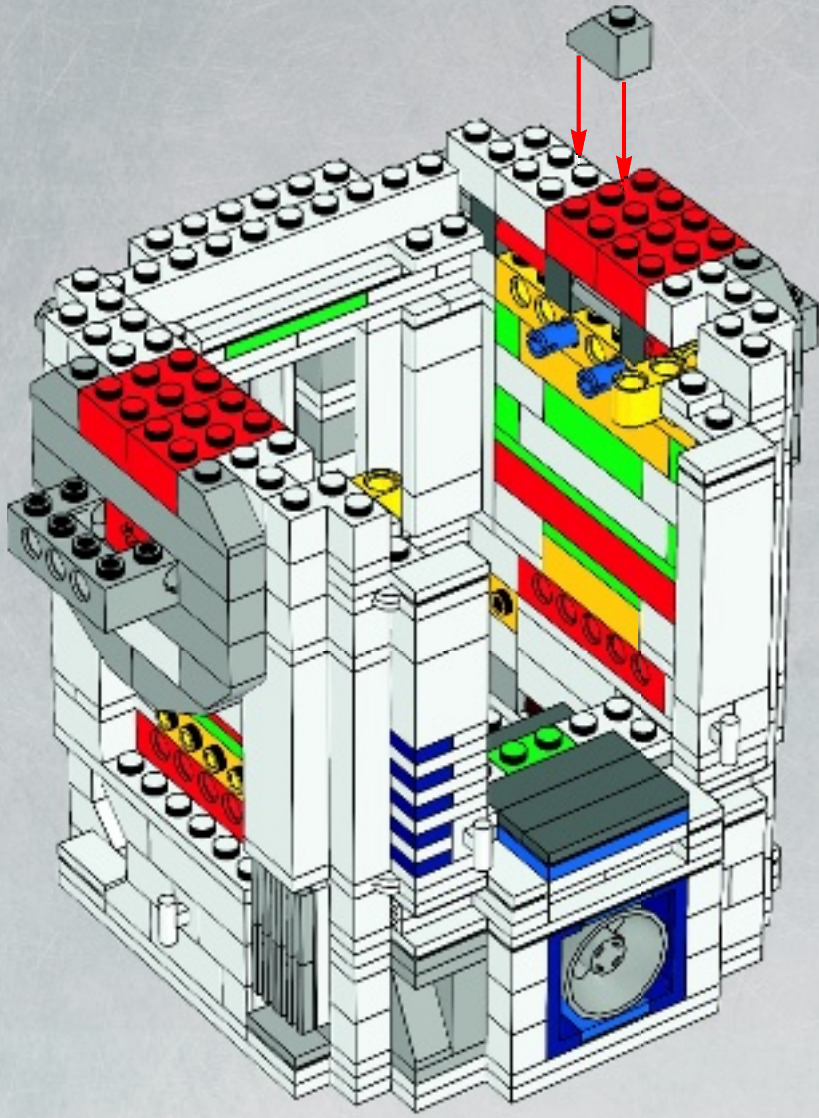

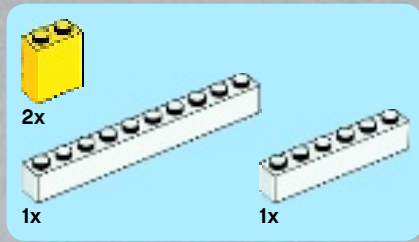

52

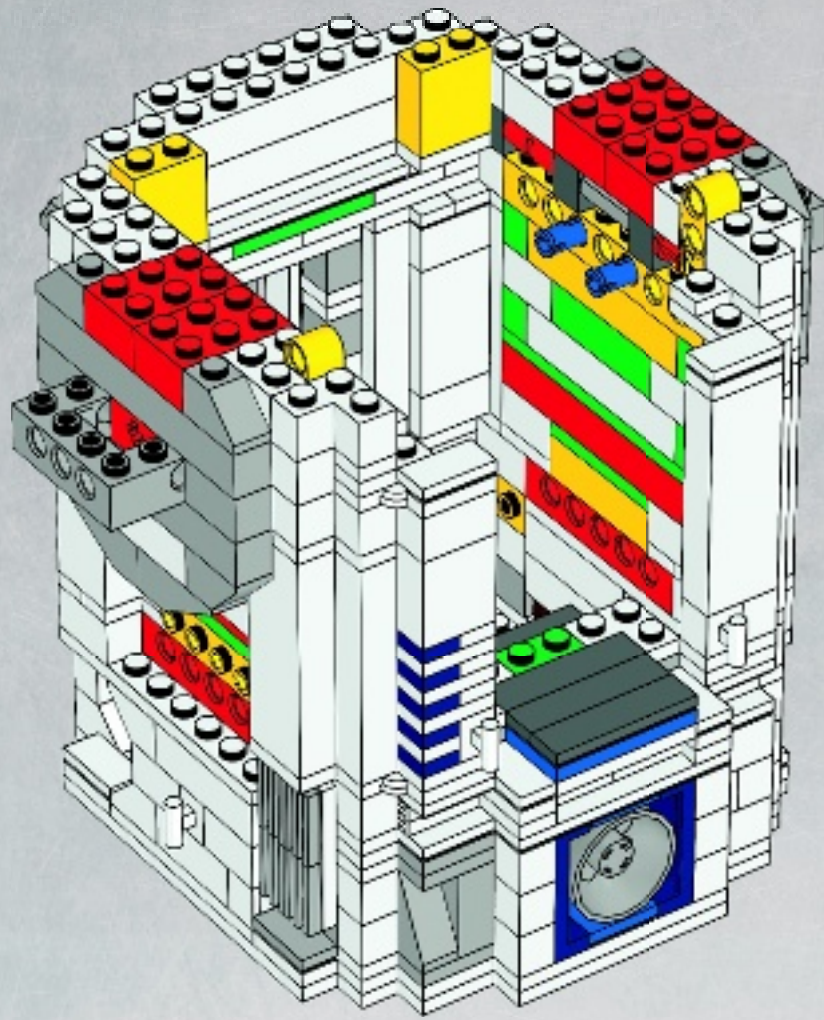

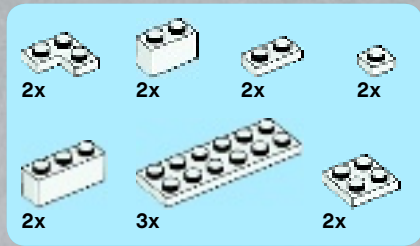

# 53

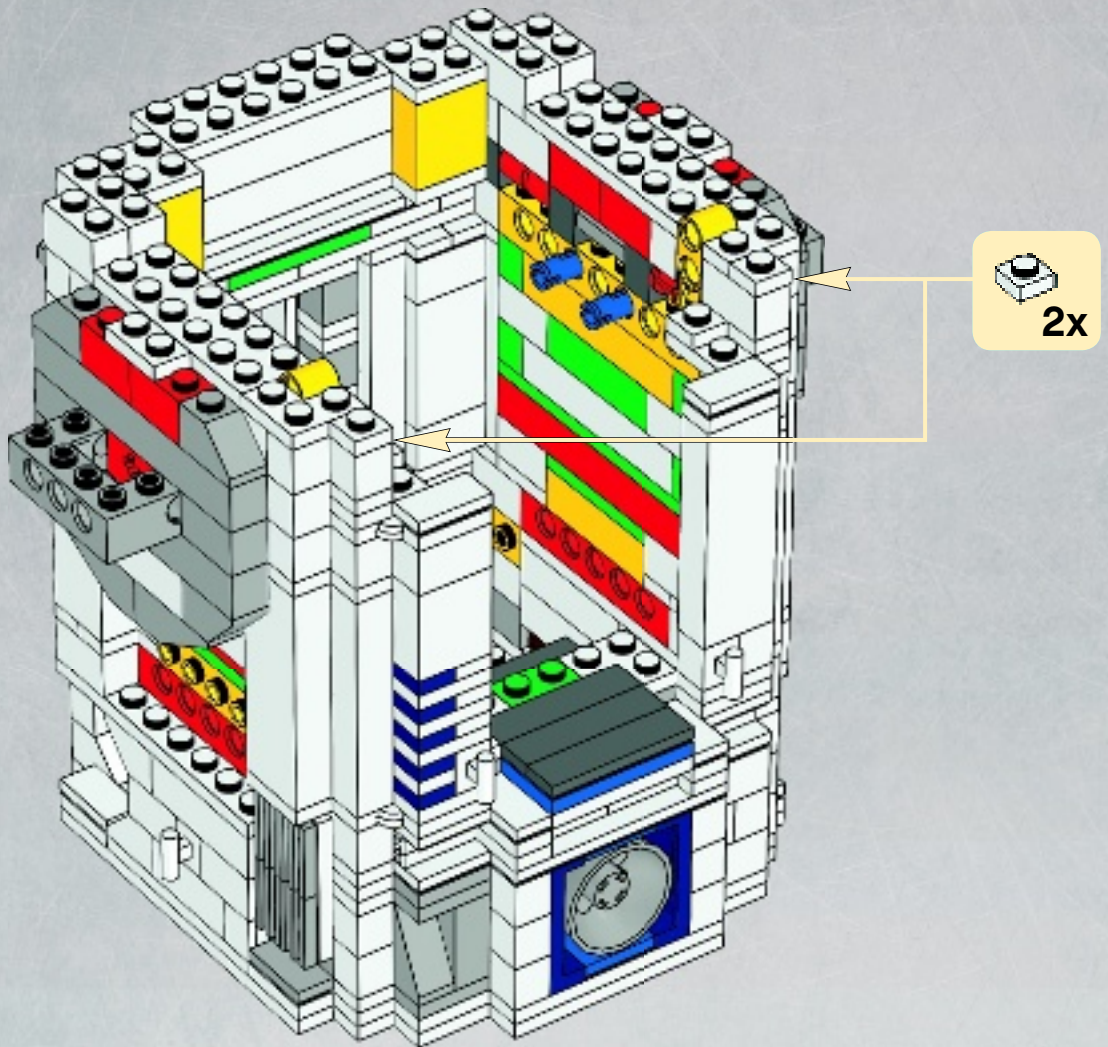



10x



4x

# 54

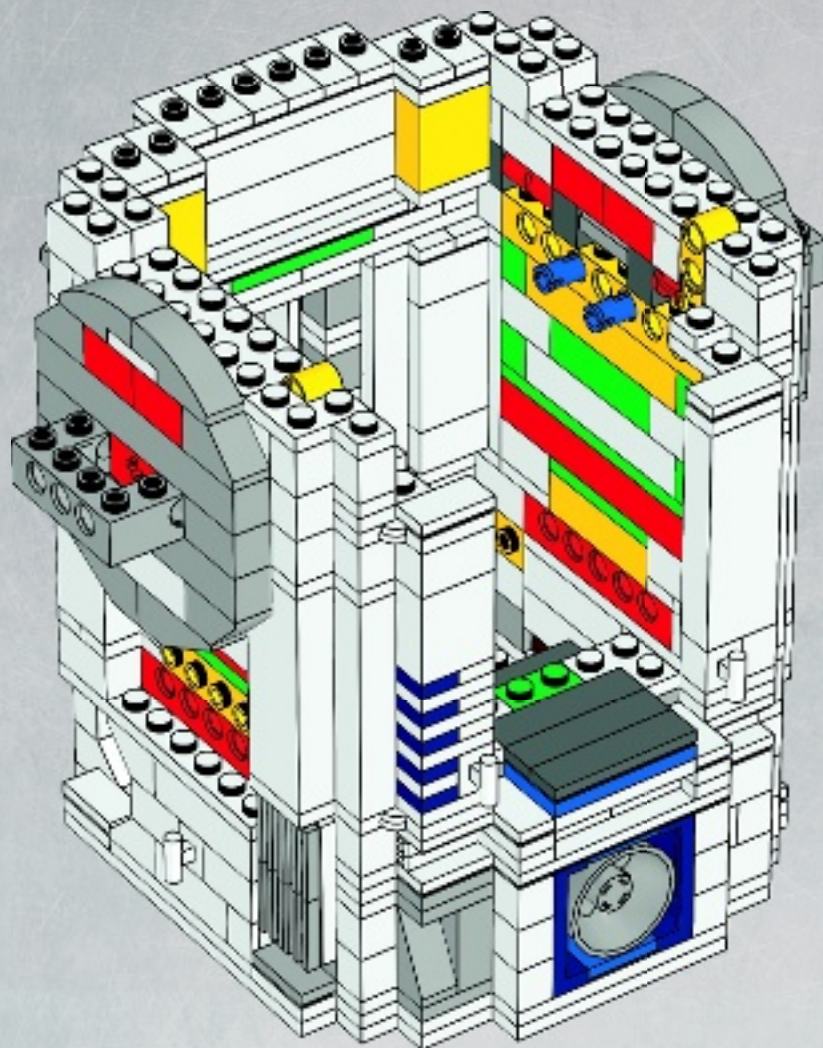

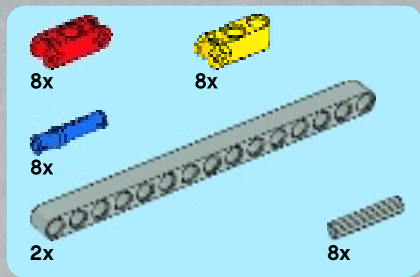

# 55

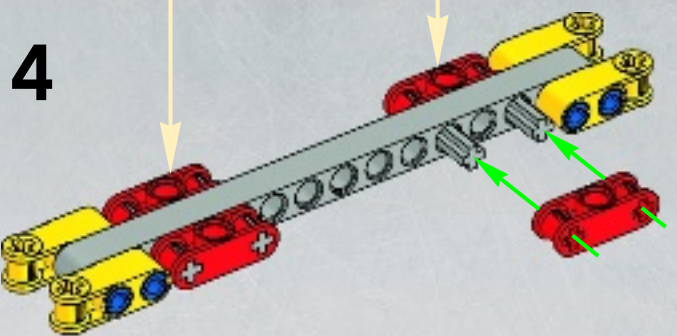
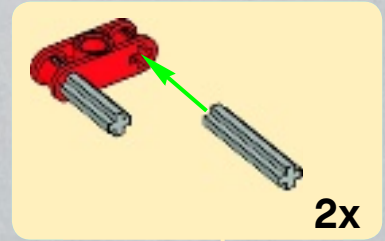
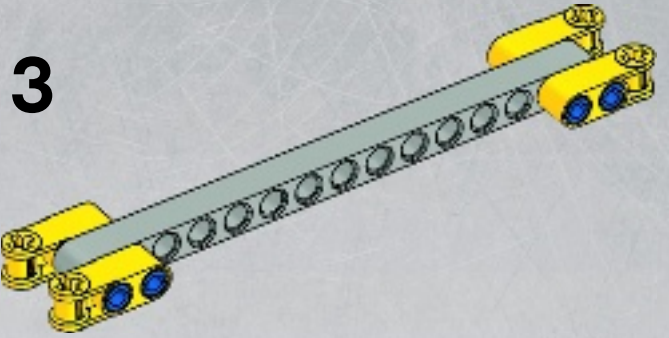
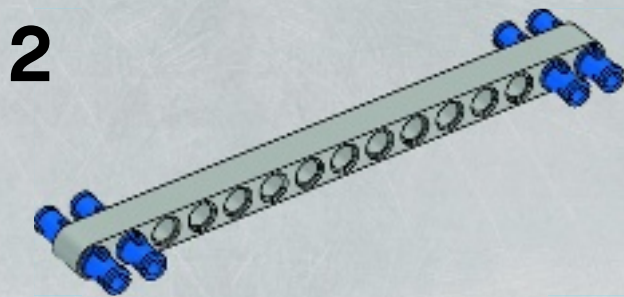
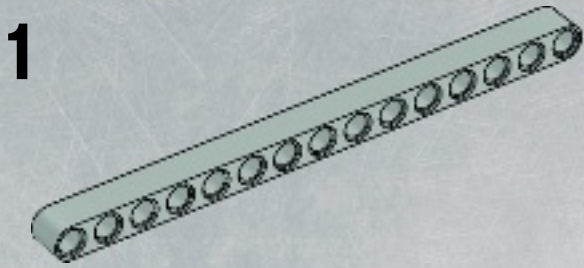

2x



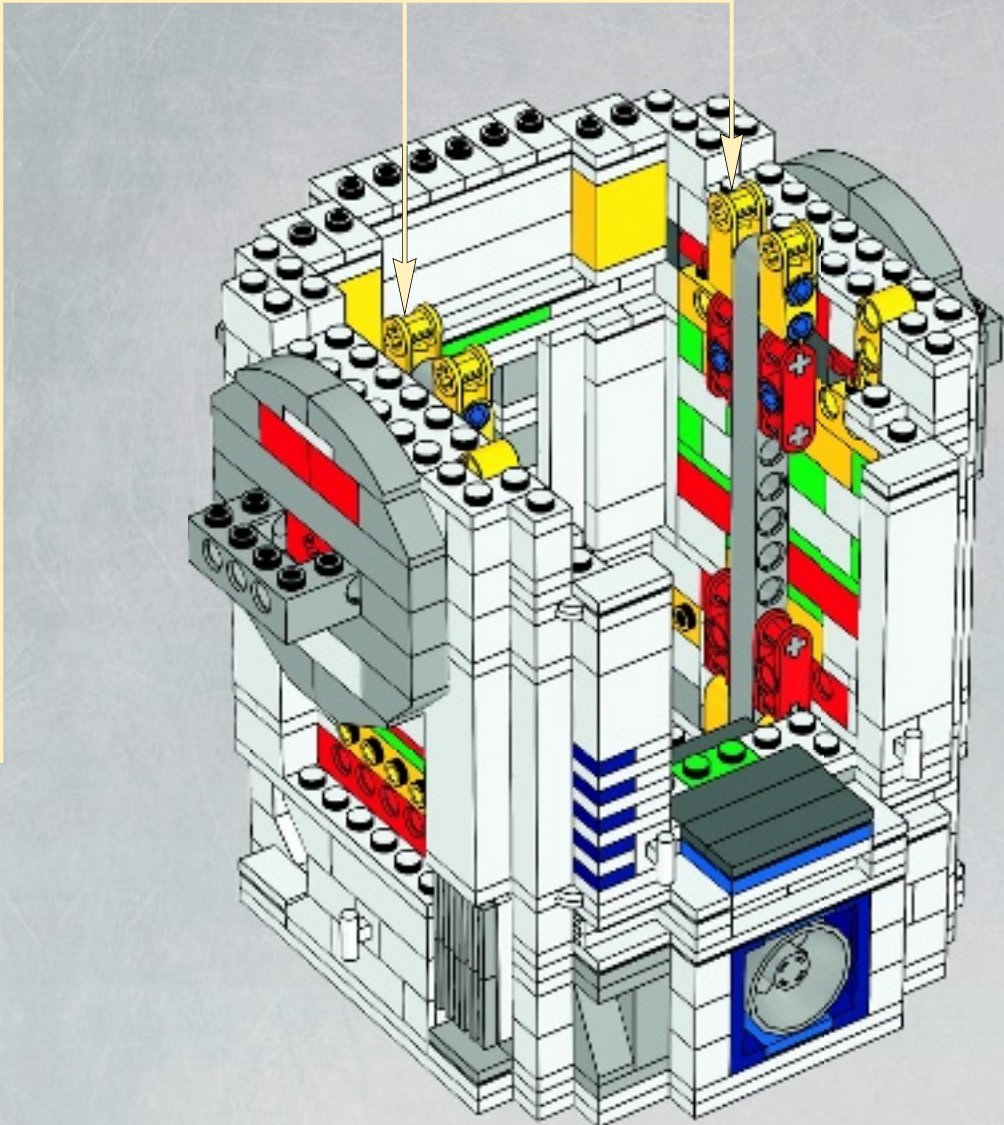



4x

# 56

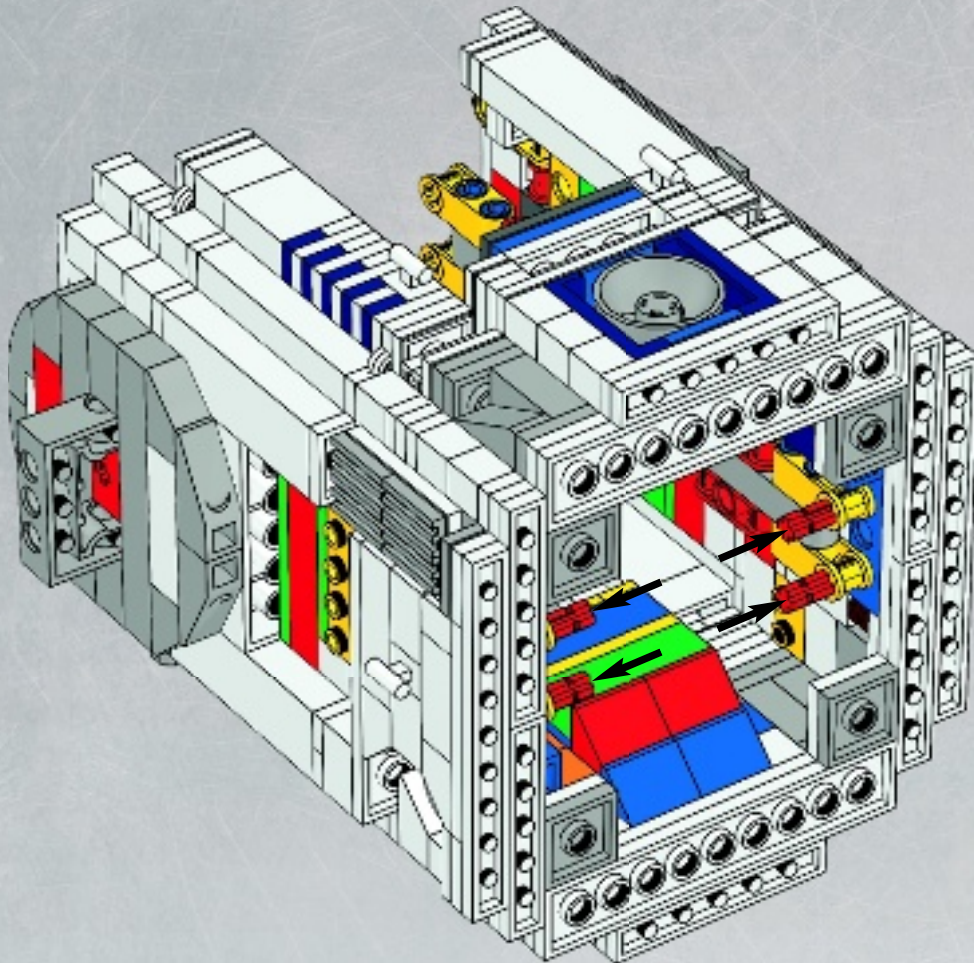

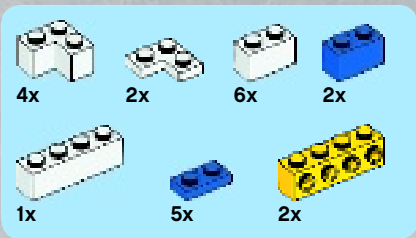
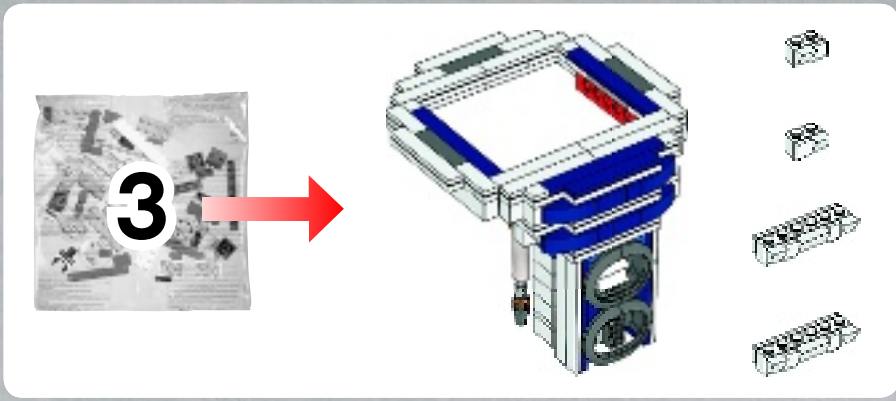

**57**

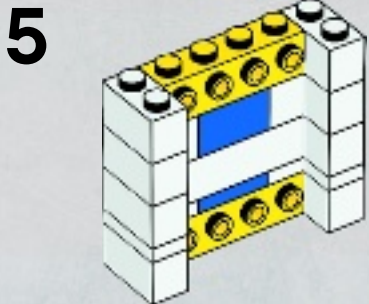
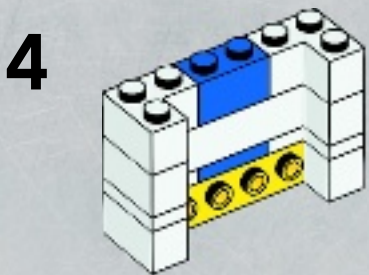
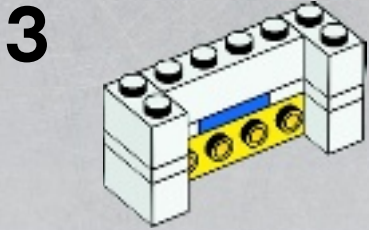
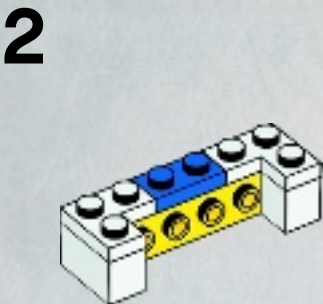
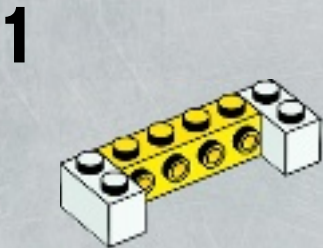

6

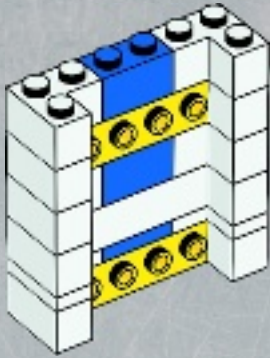

7

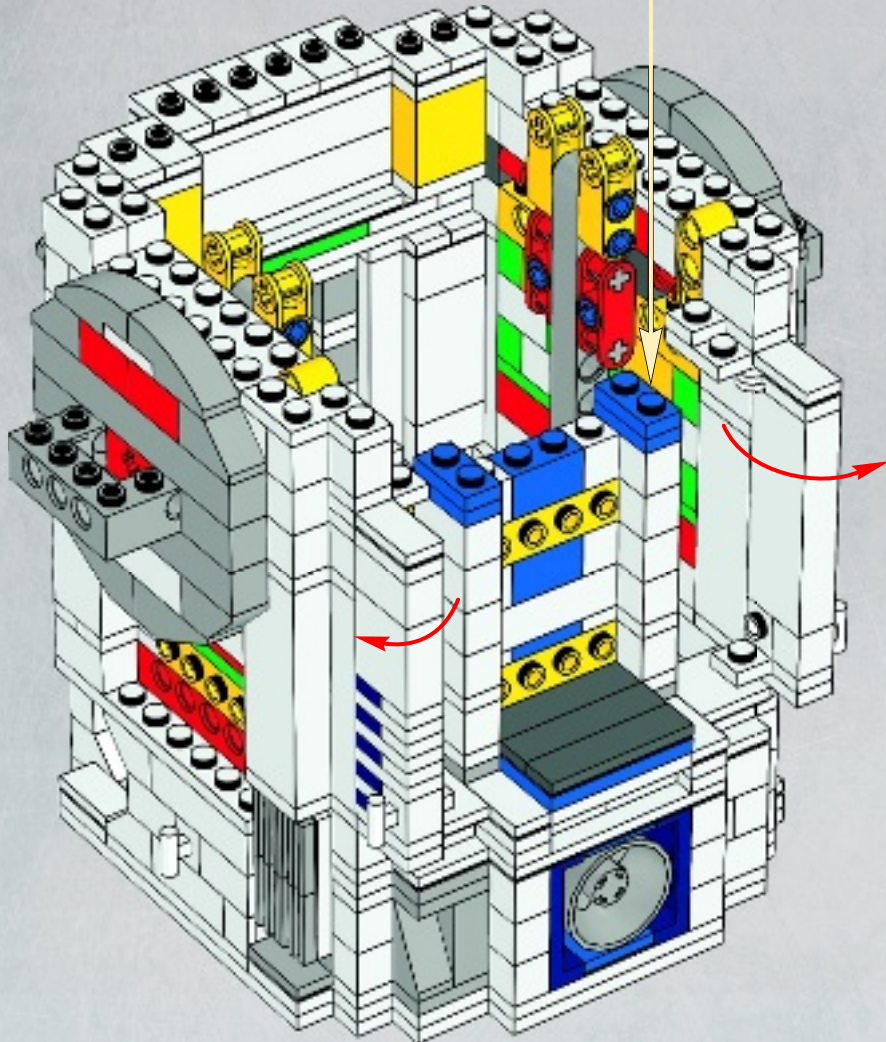
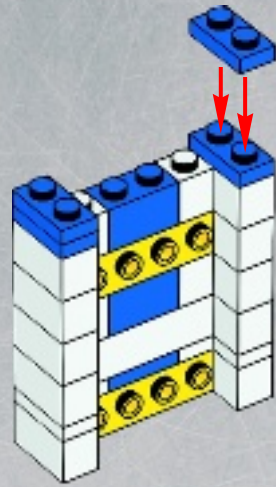



2x

1

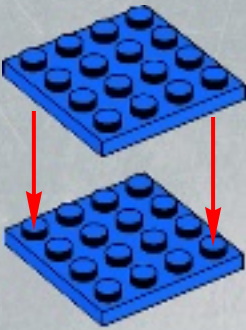

1x

2

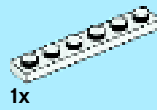

1x



2x

3

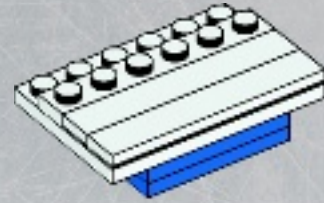

1x



2x

4

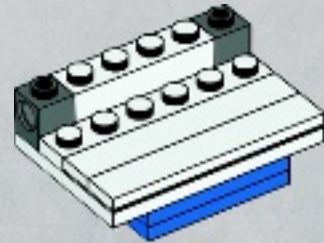

2x



2x

5

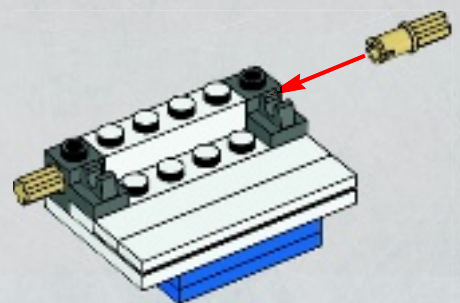

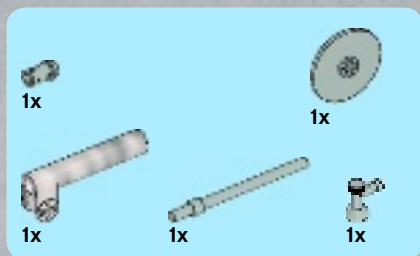

6

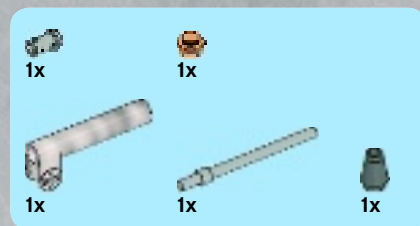
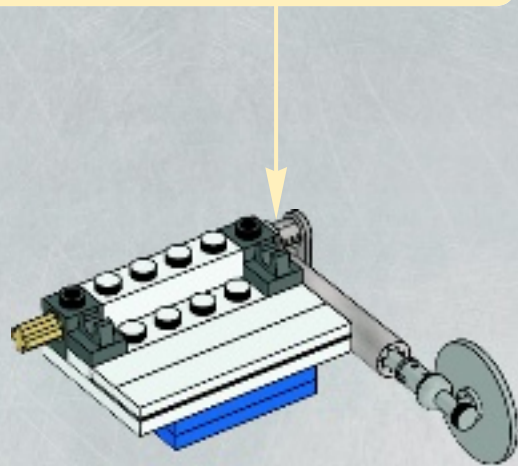
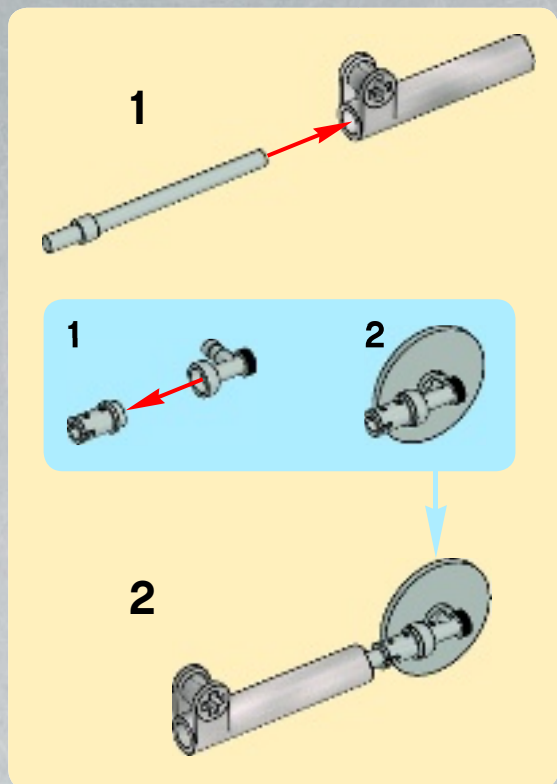

7

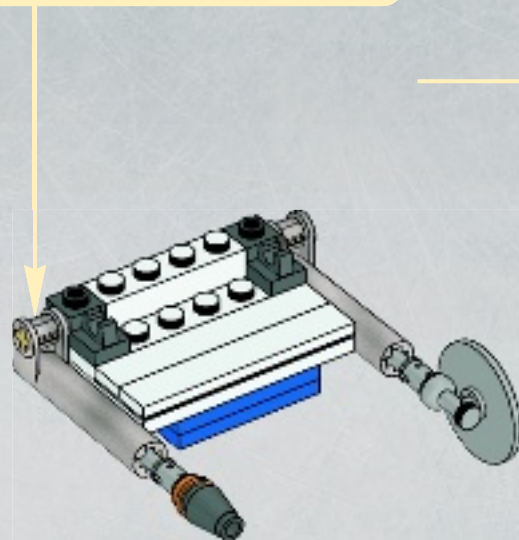
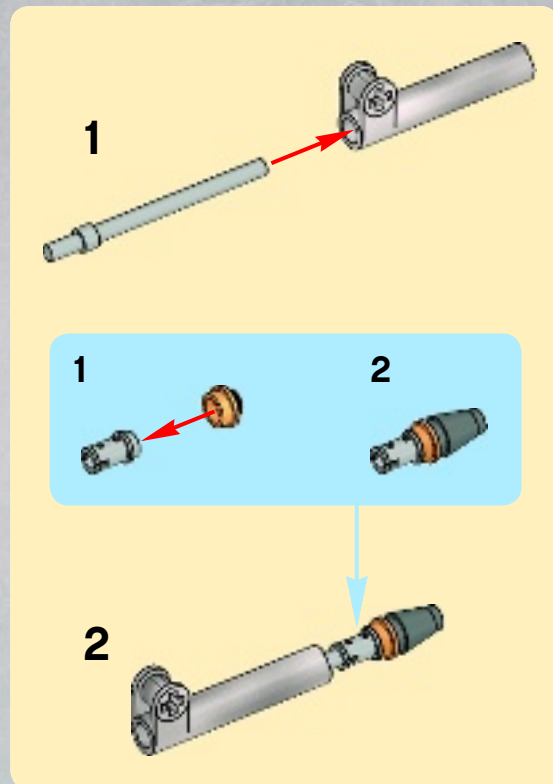

8

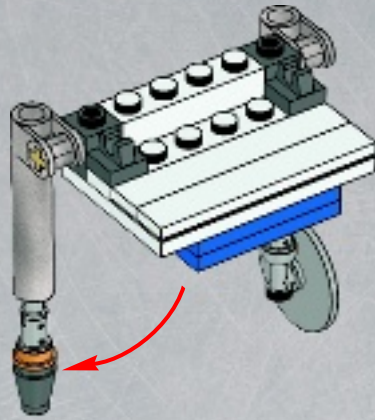

58

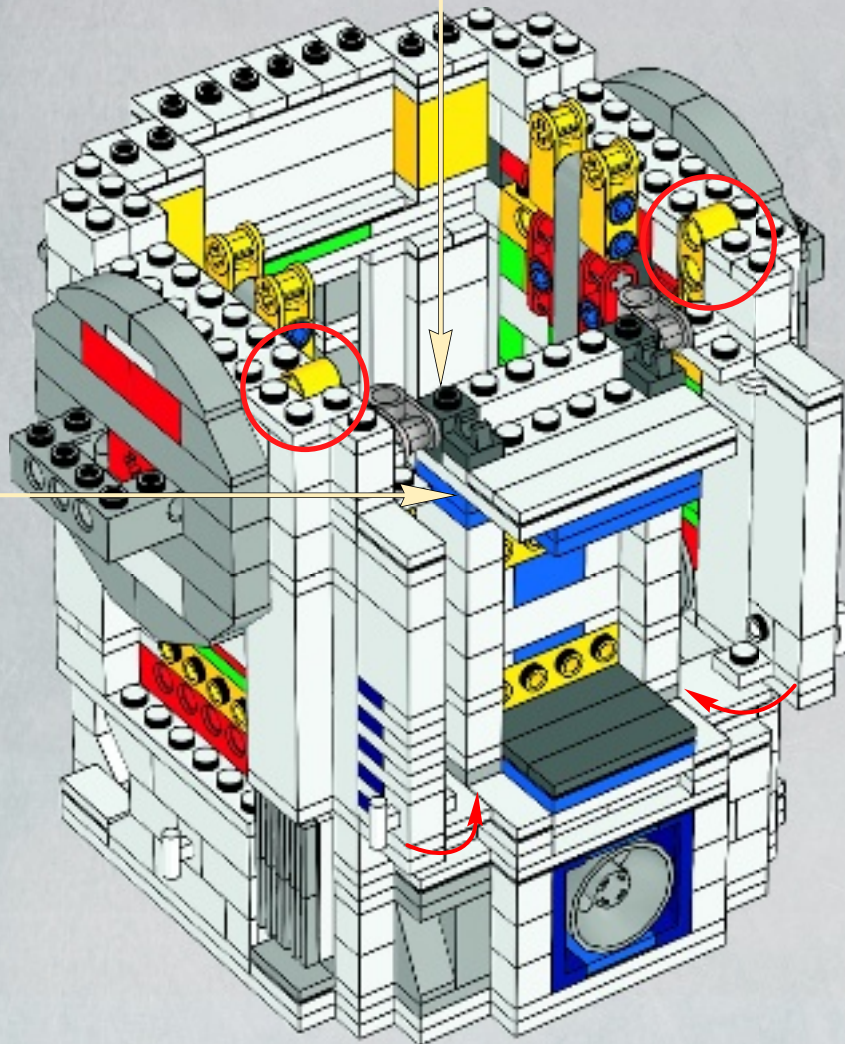

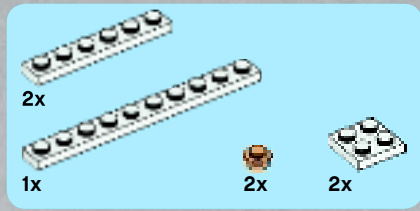

# 59

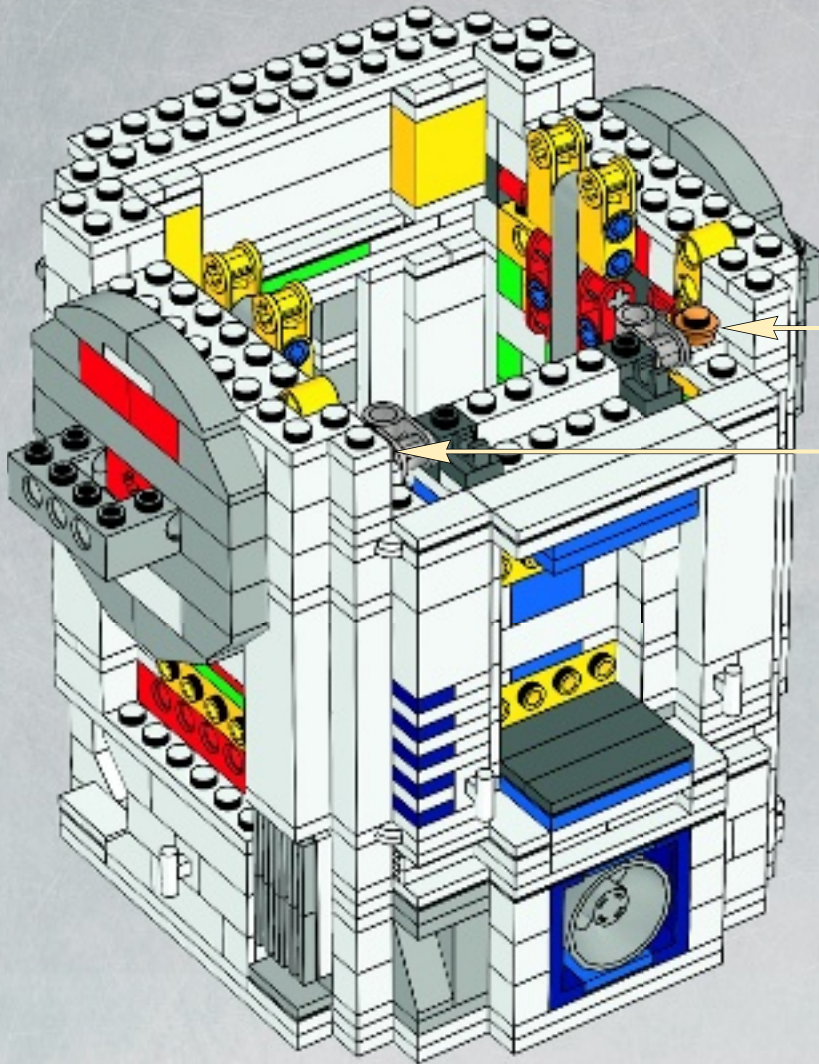



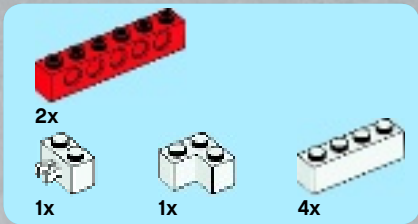

60

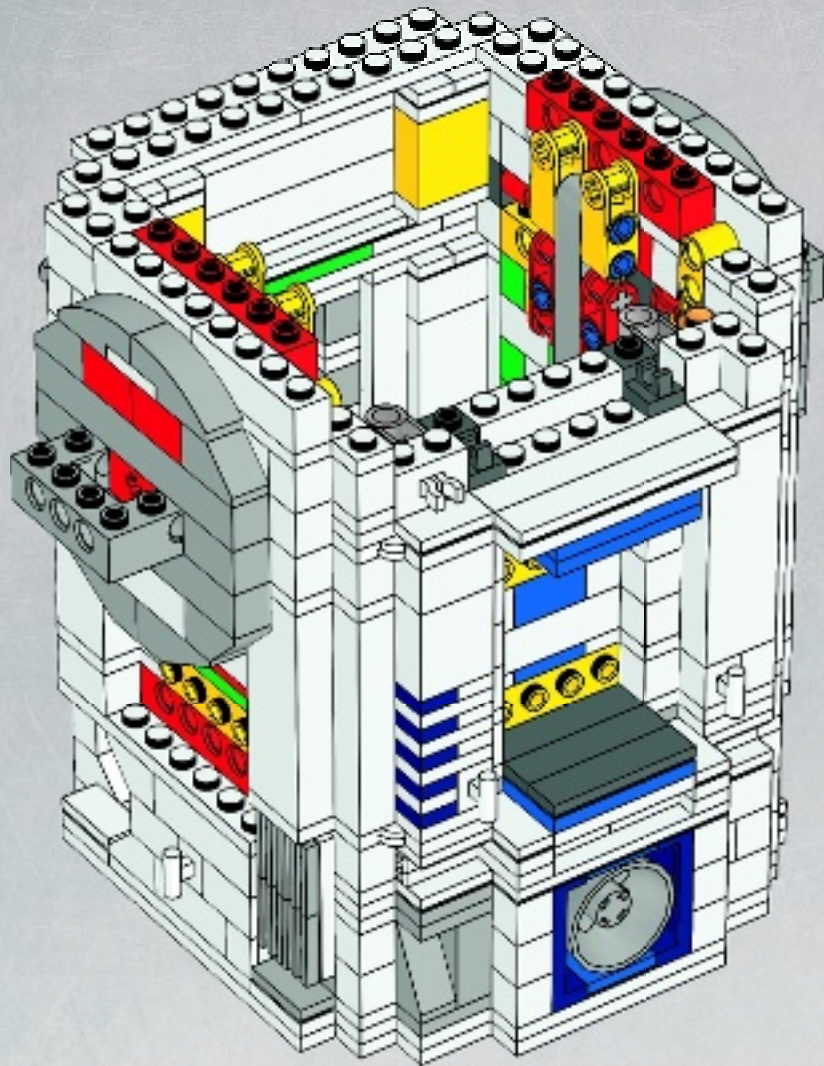

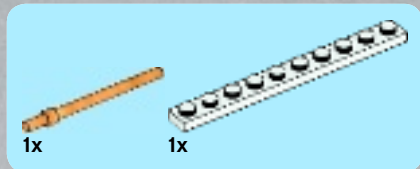

# 61

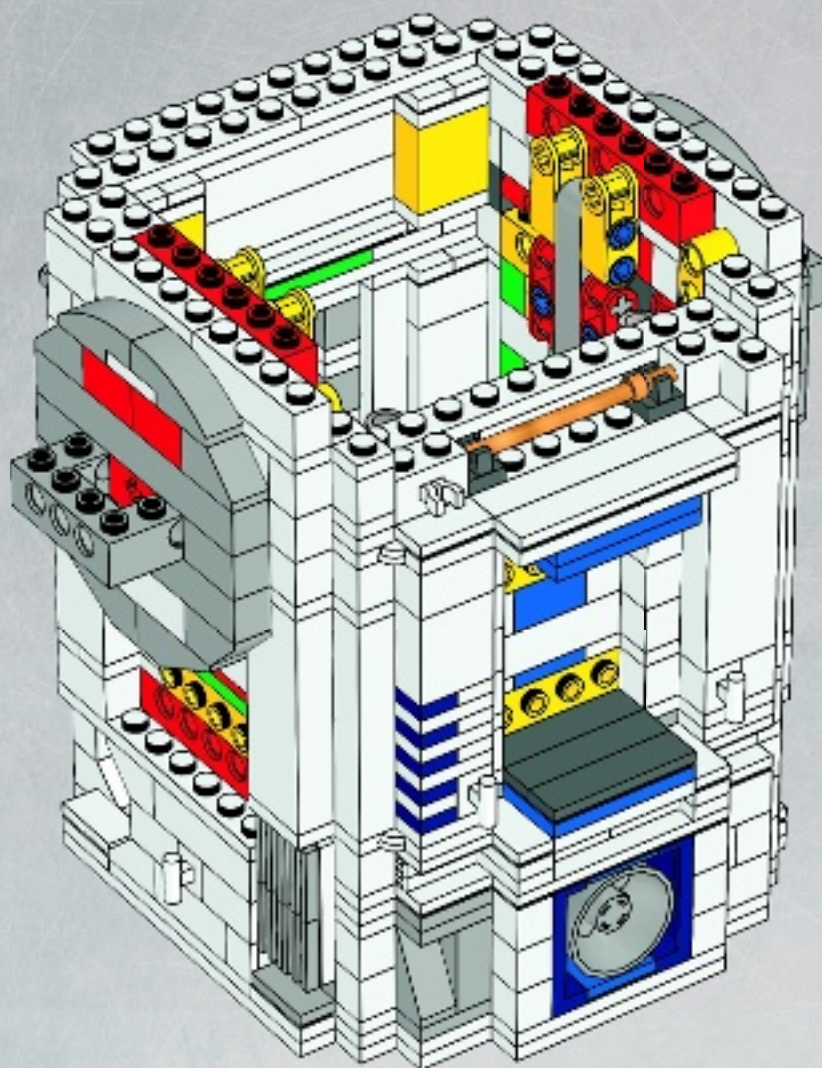

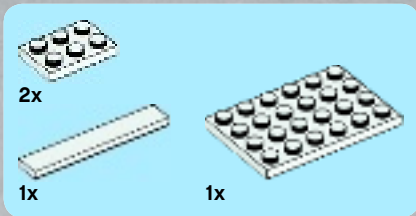

# 62

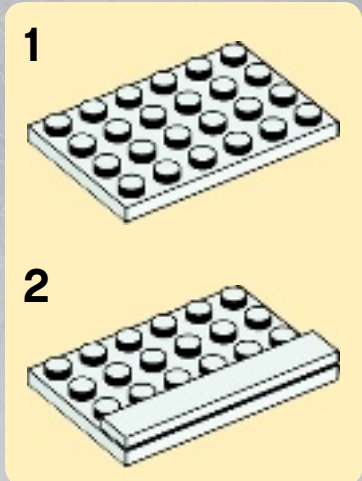
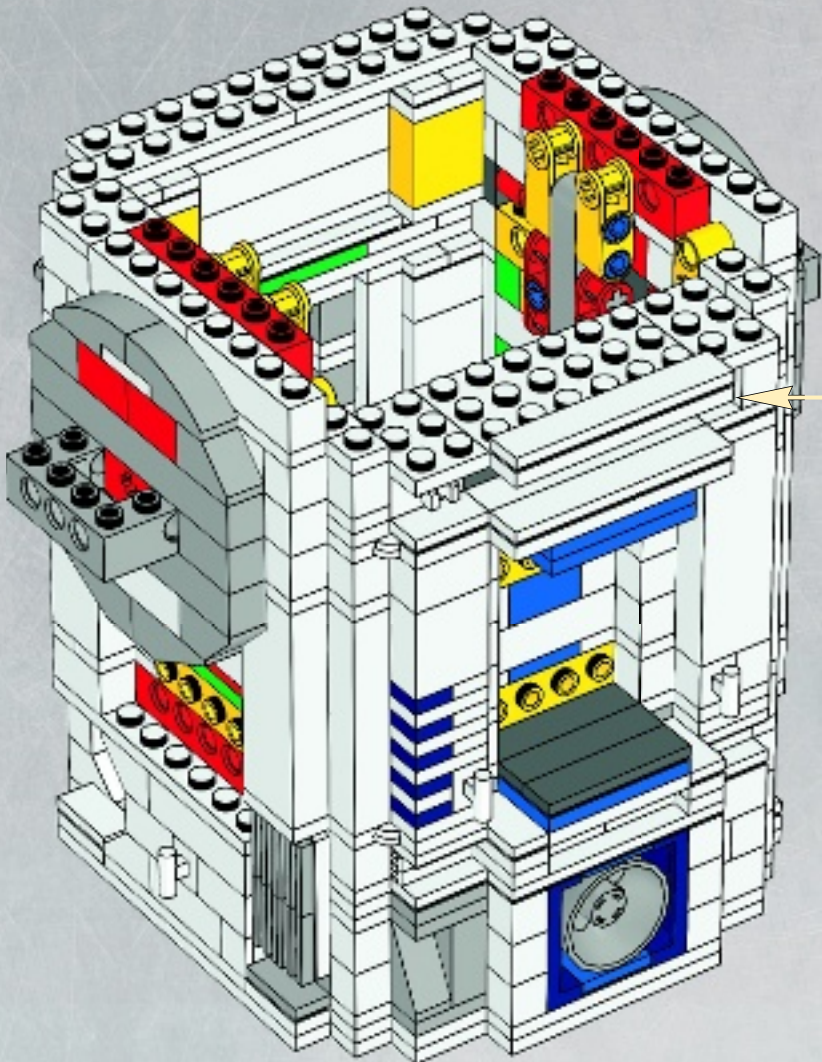

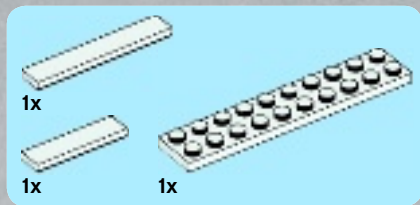

# 63

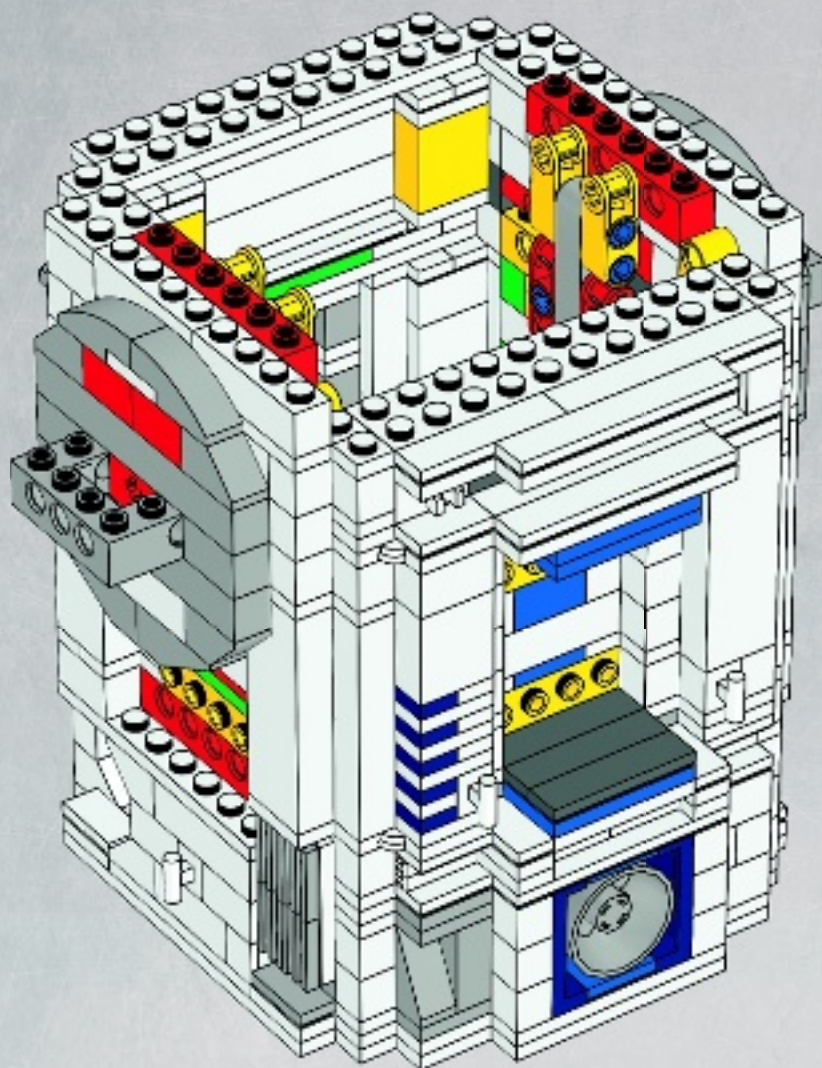

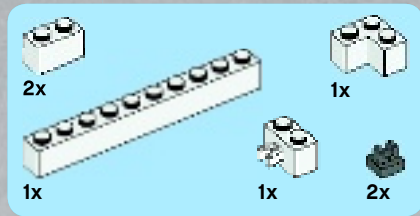

64

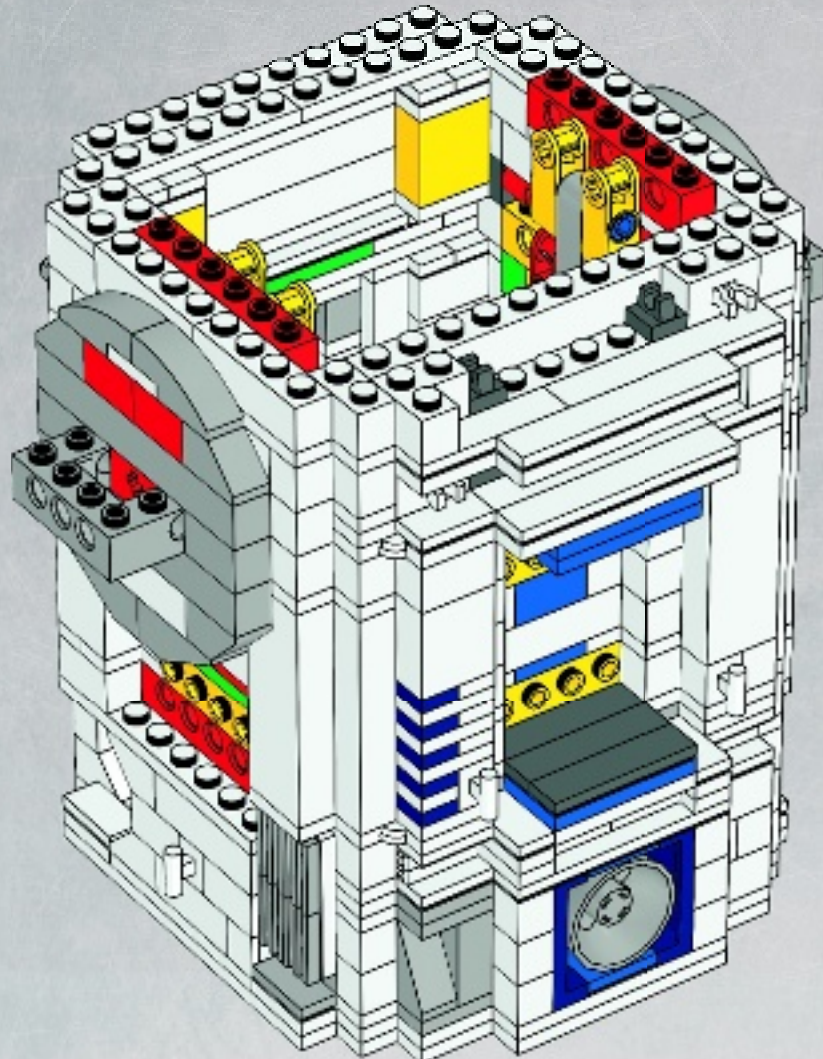

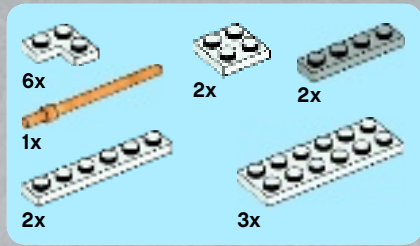

65

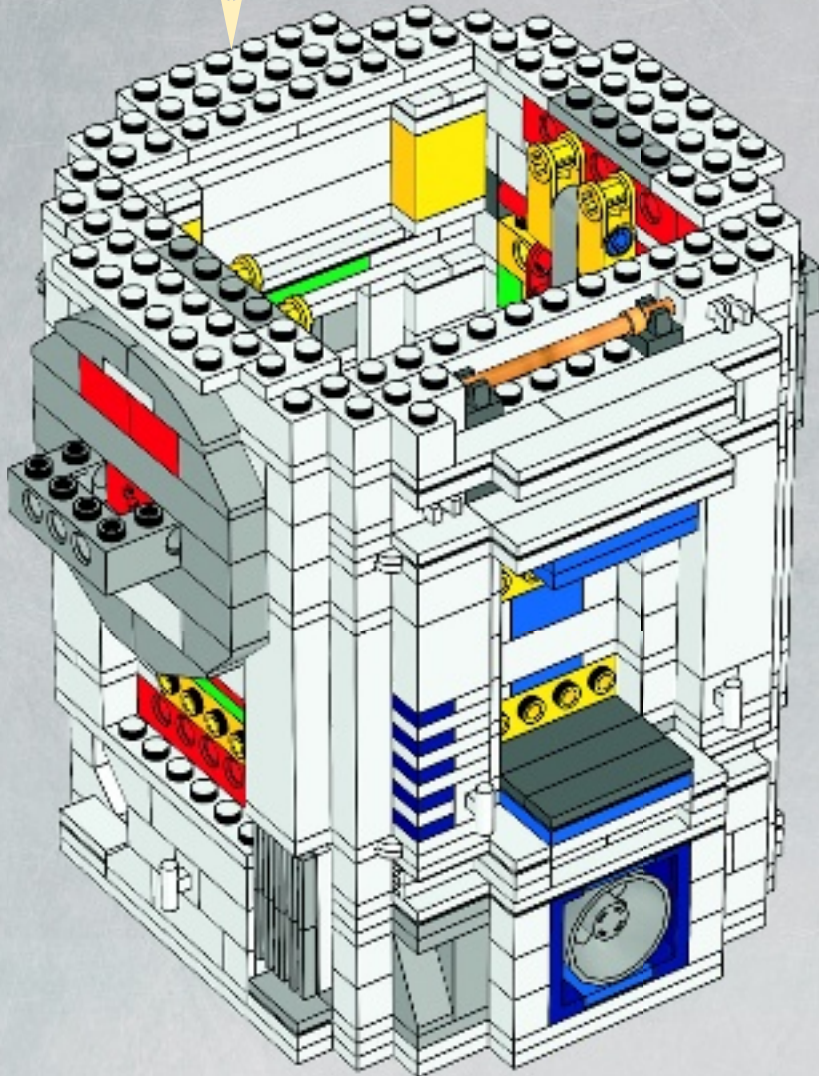
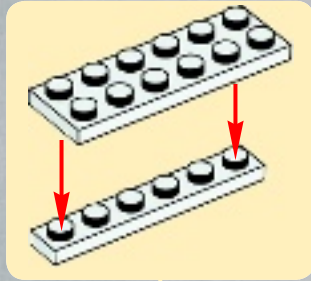

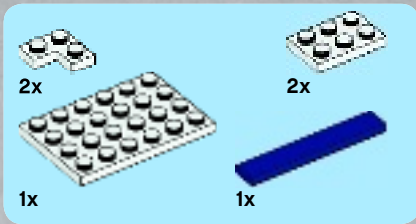

# 66

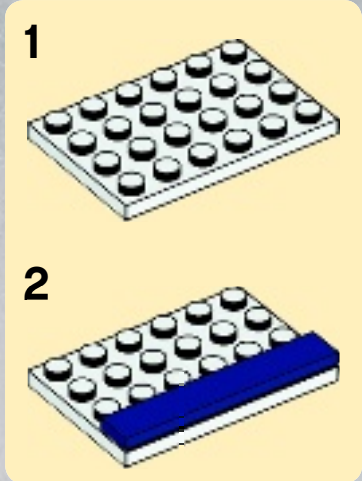
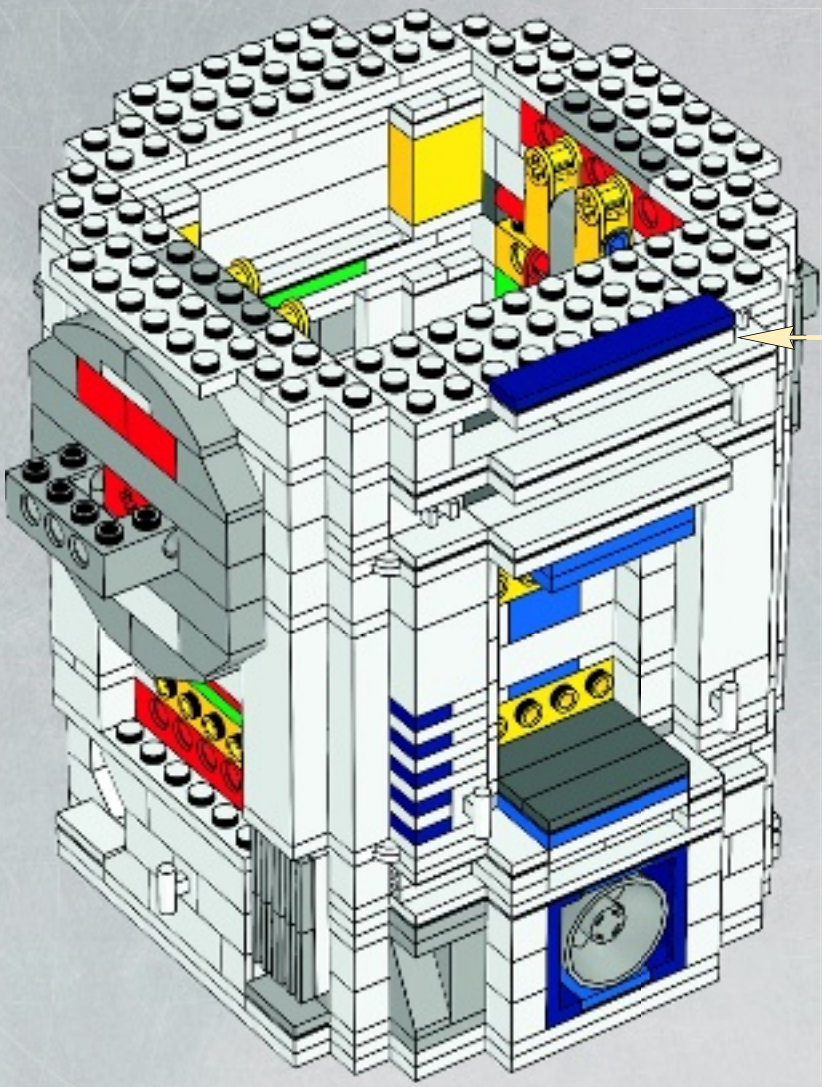

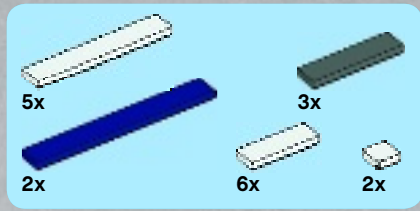

67

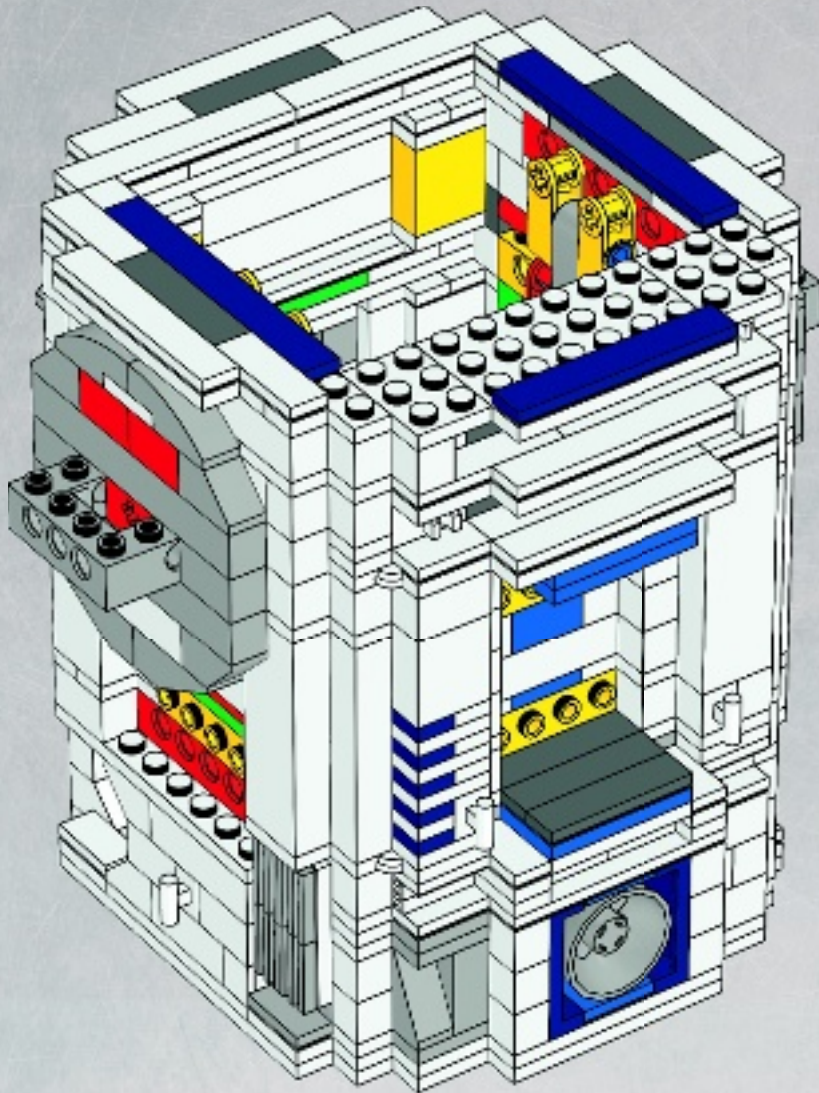



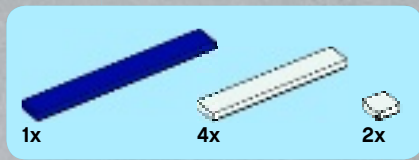

68

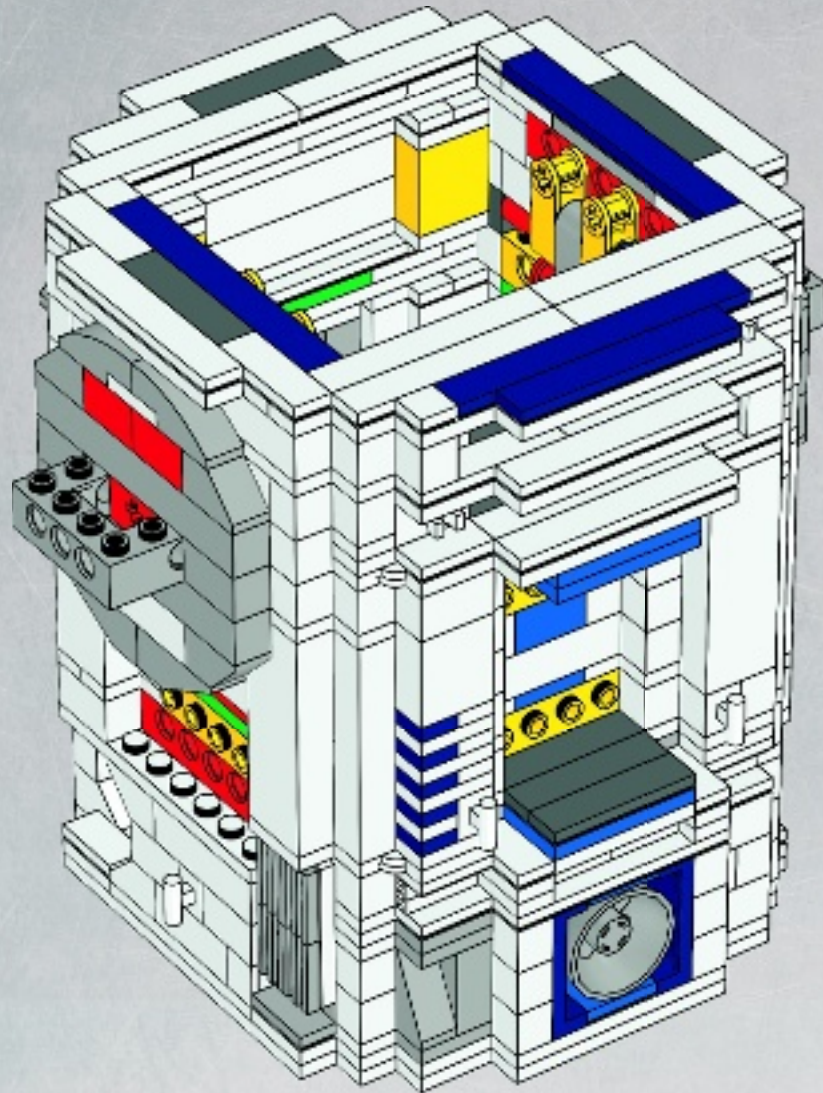

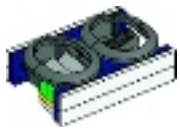

1x



2x

1

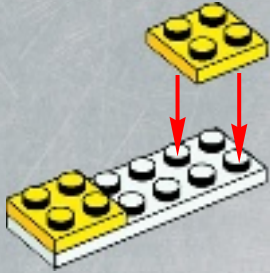

8x

2

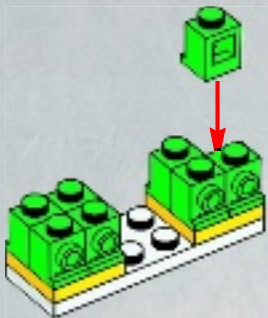

2x



1x



2x

3

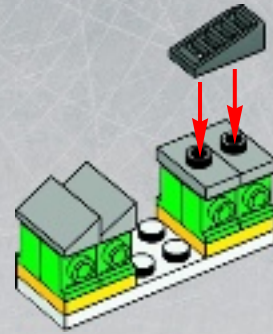

4x

4

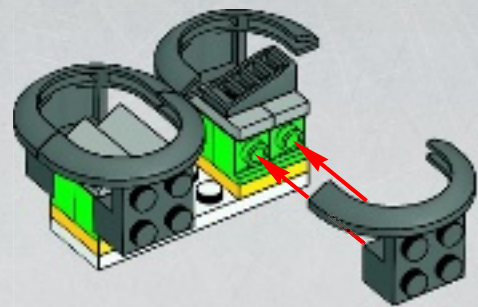

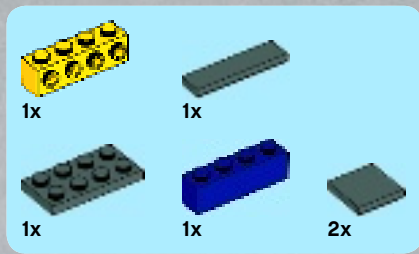

5

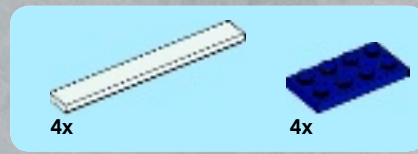
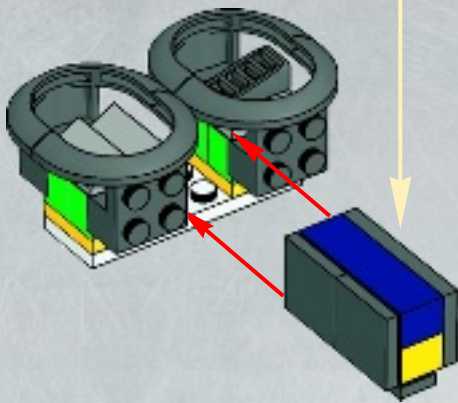
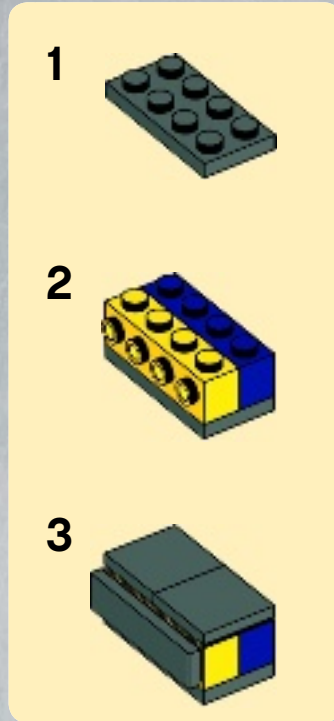

6

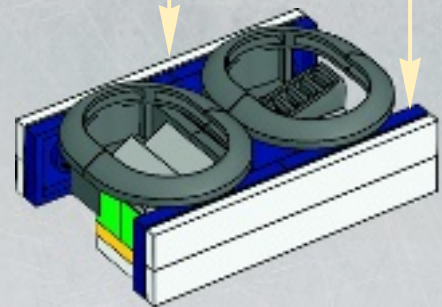
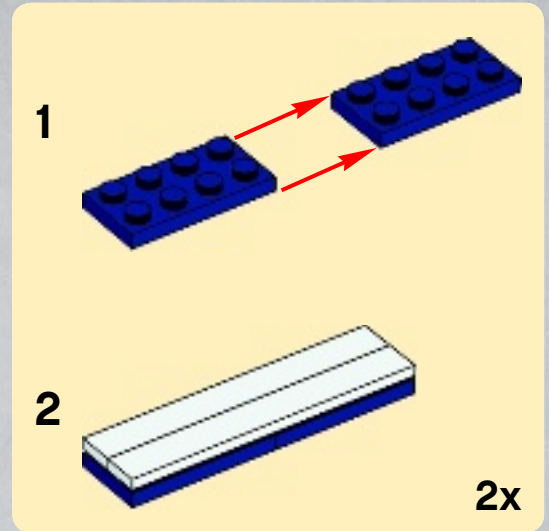

69

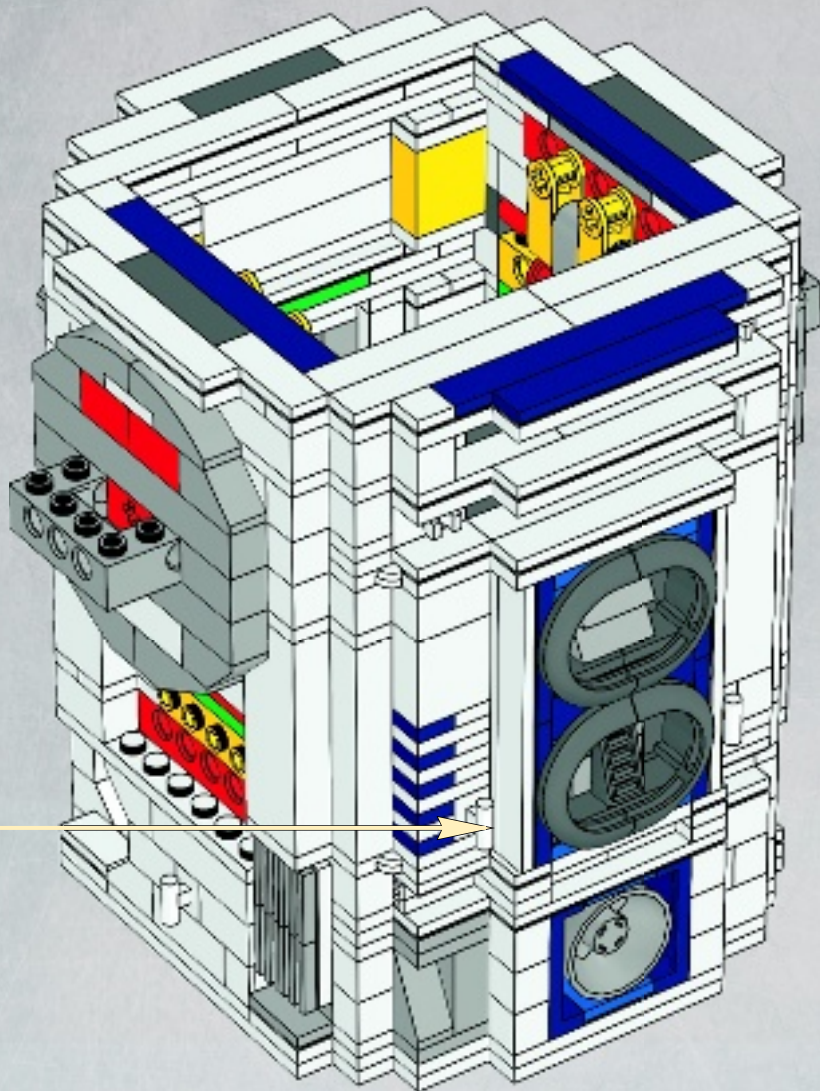



# 70

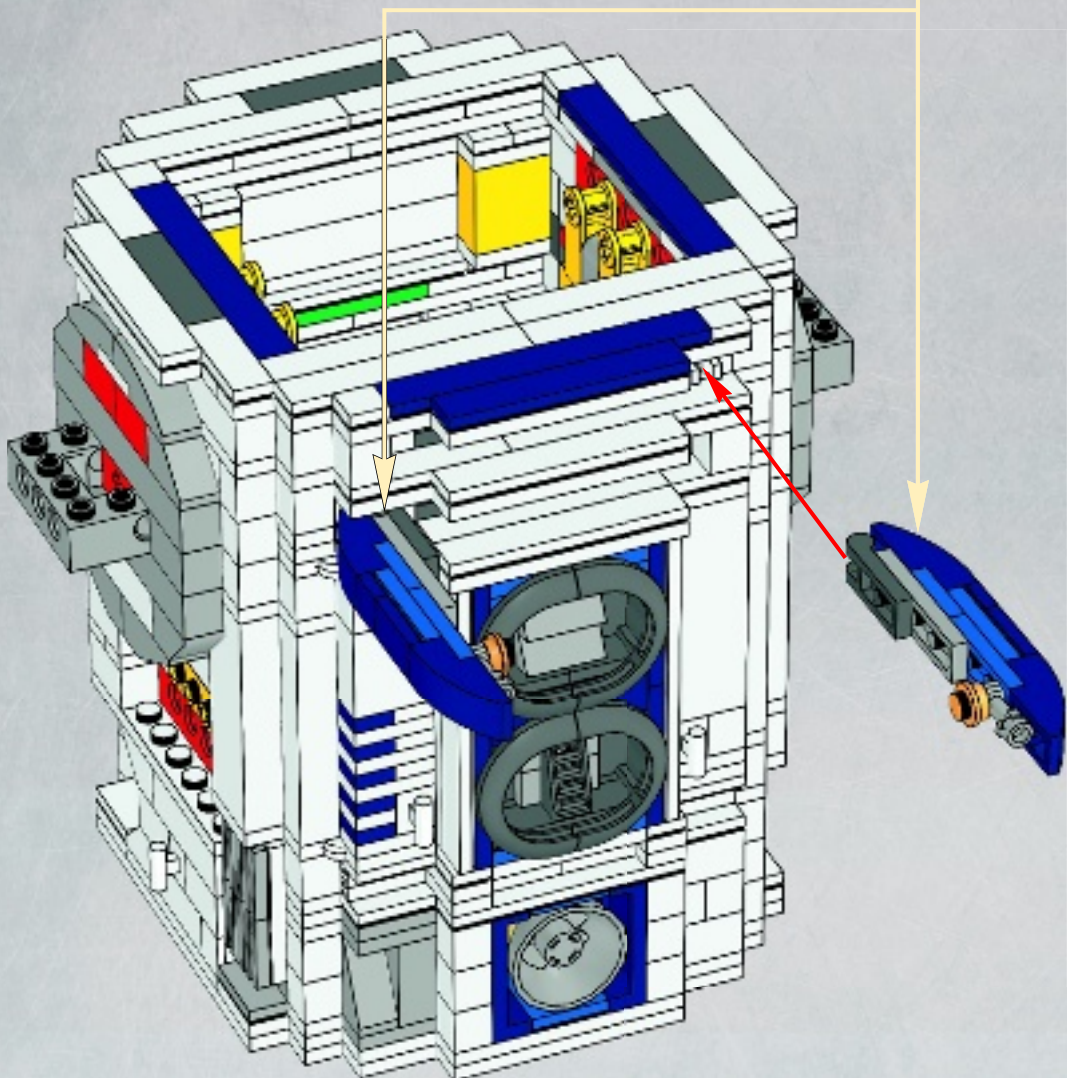

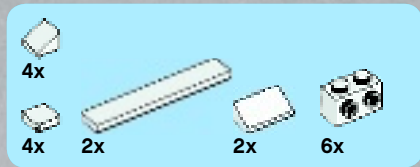

# 71

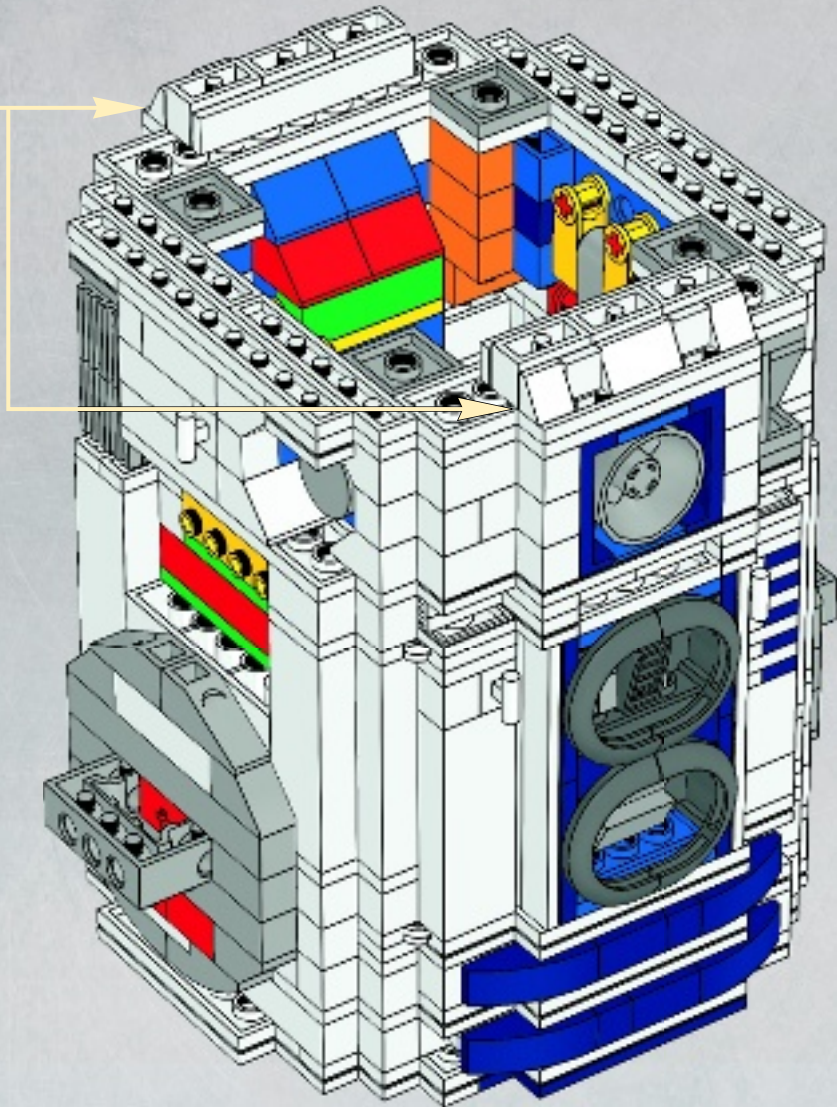
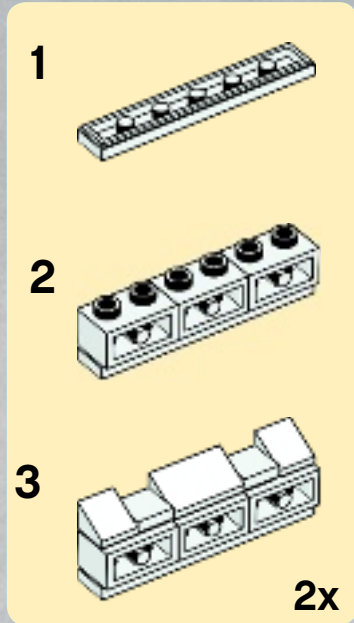



2x



2x



2x

# 72



1

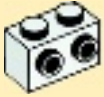

2

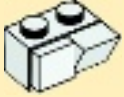

1

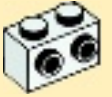

2

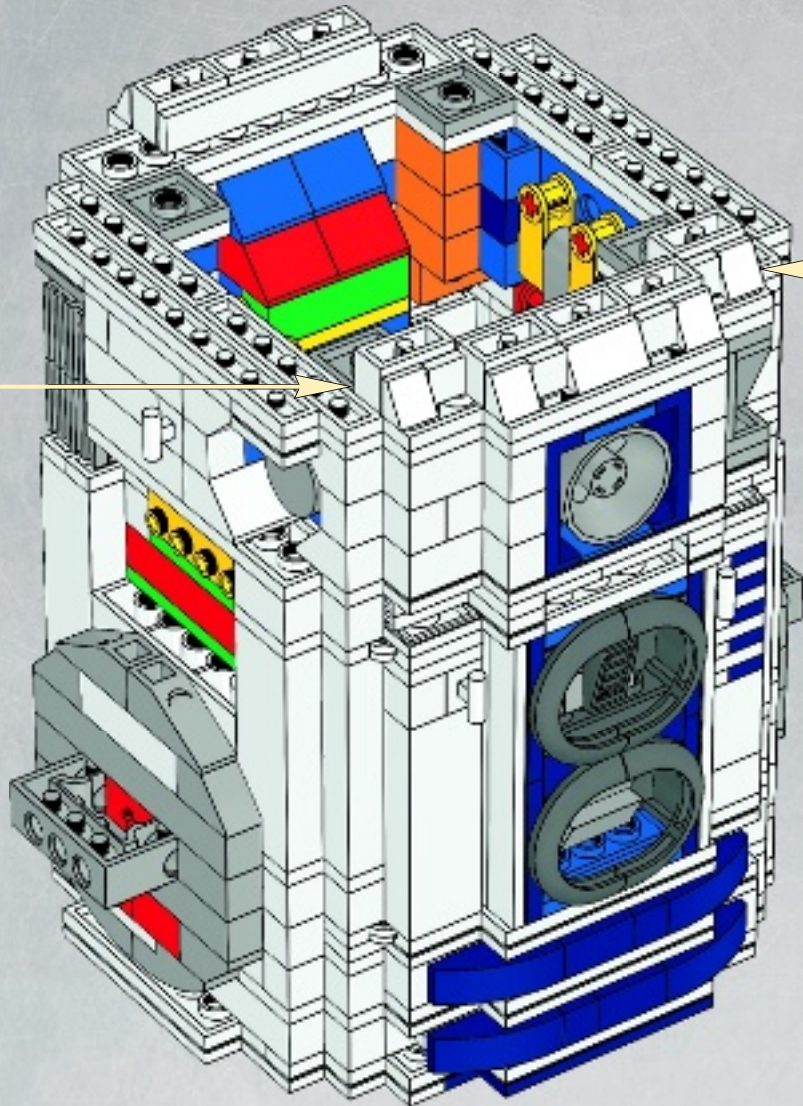

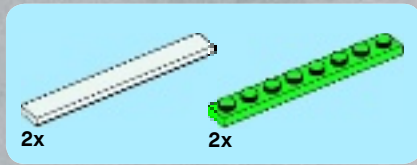
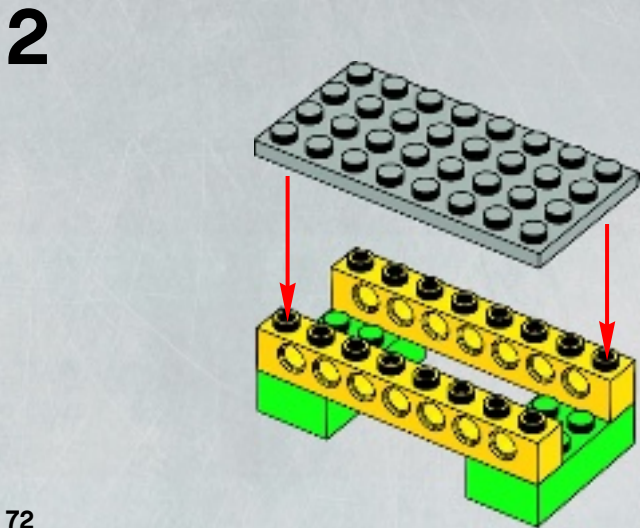
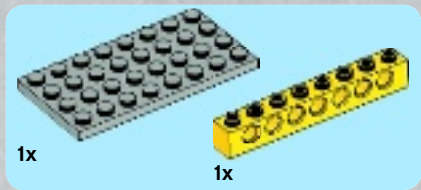
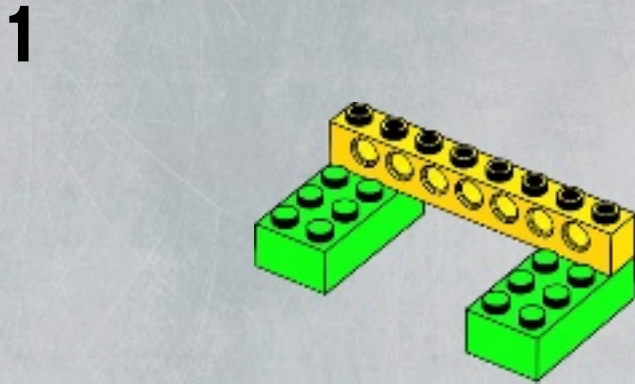
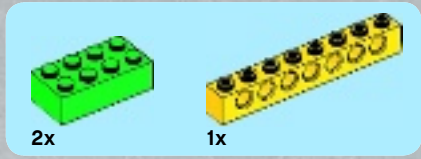
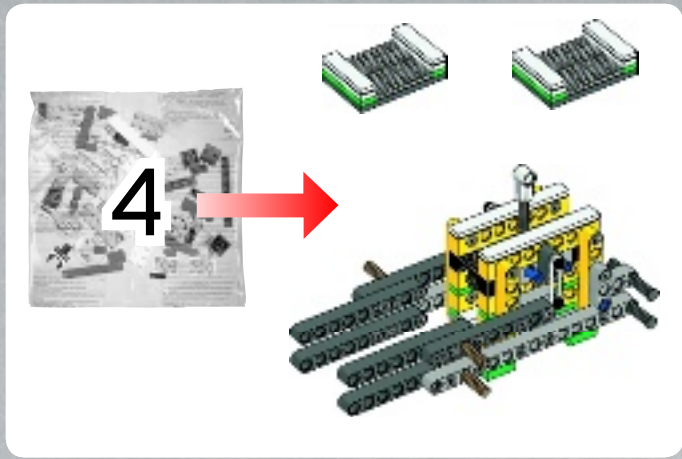

3

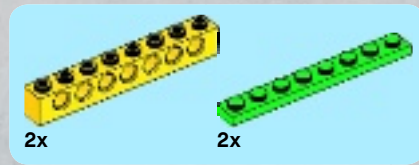
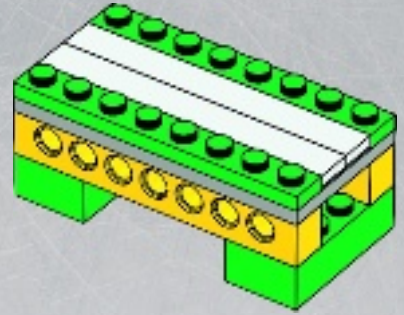

4

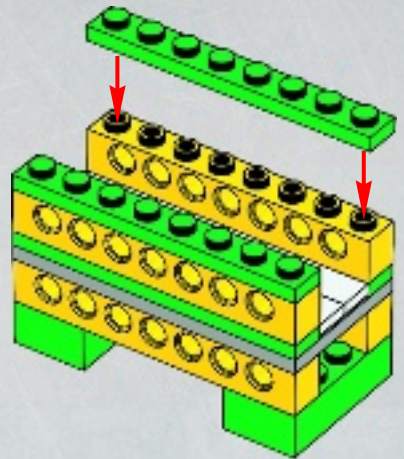



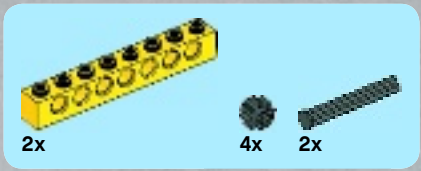

5

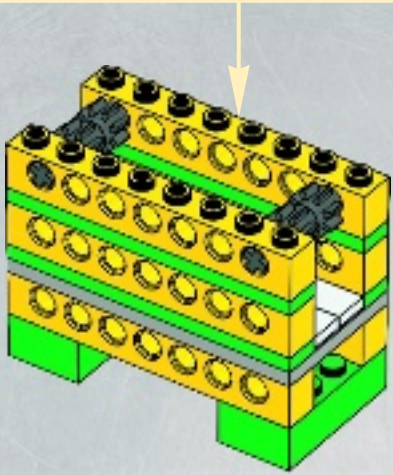
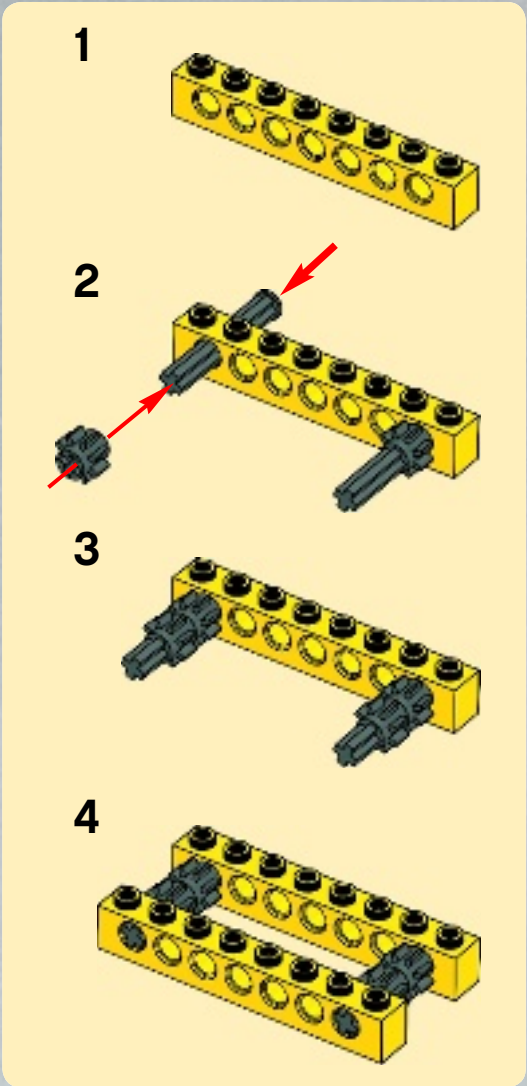

6

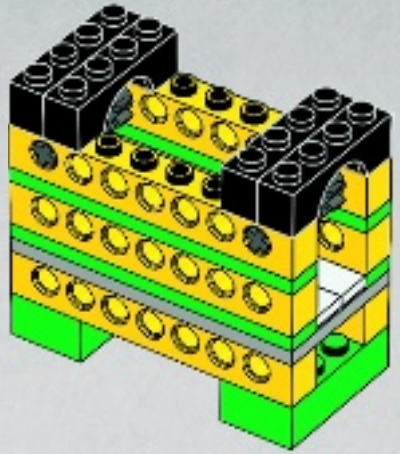

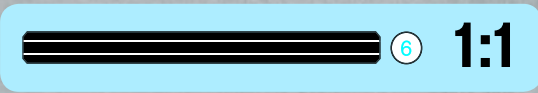
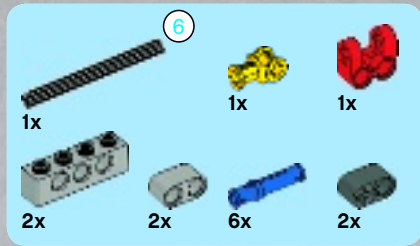

7

1

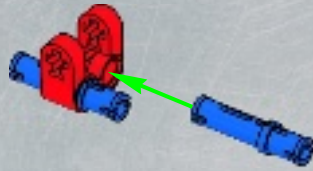

2

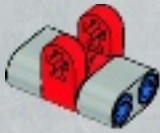

3



1

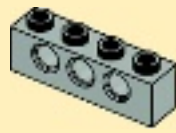

2

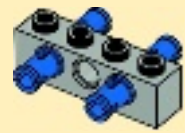

2x

4

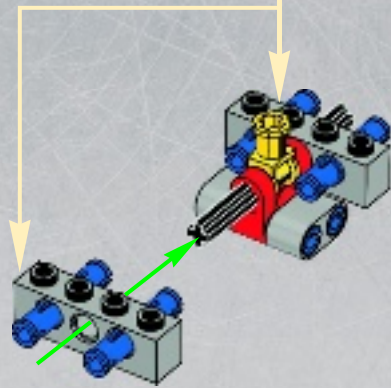

5

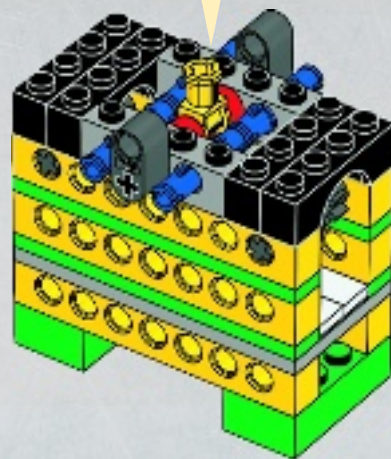
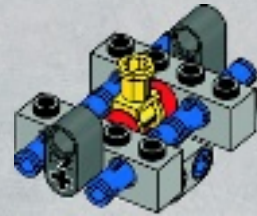

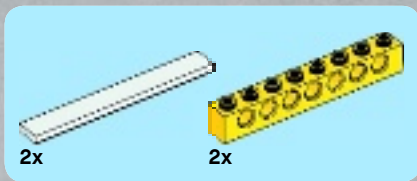

8

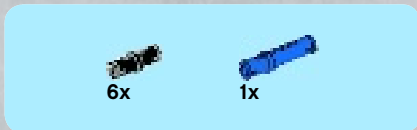
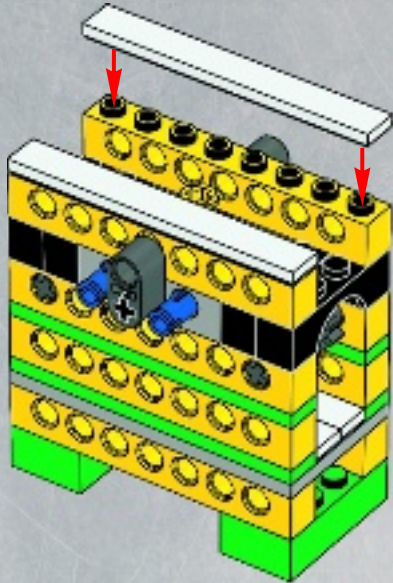

9

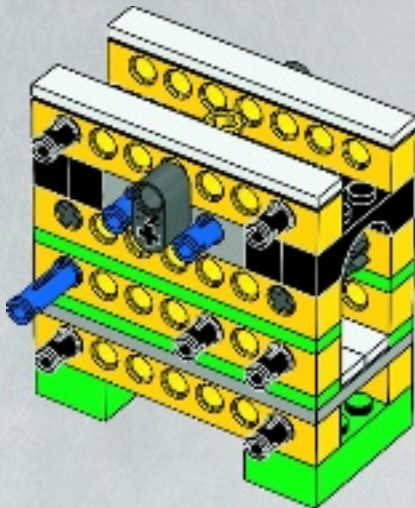

10

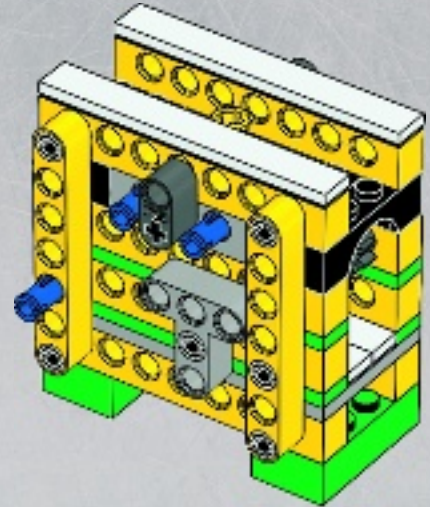



6x



2x

# 11

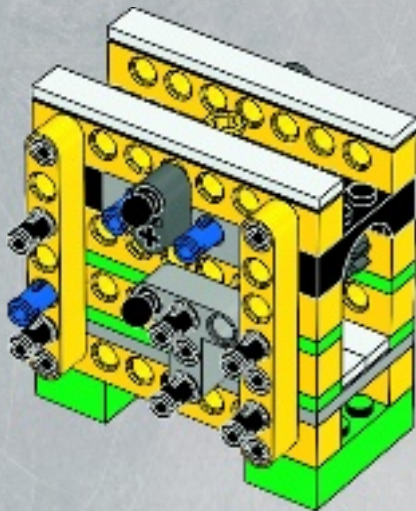

6x



1x

# 13

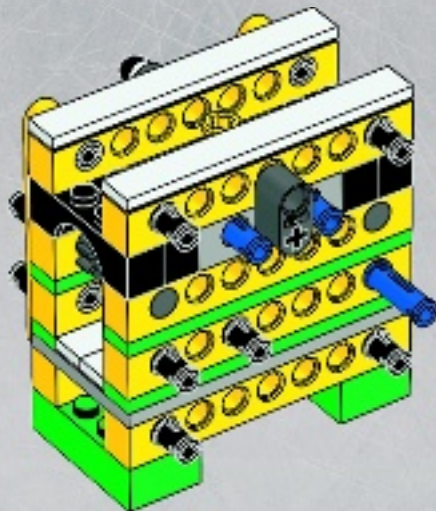

2x



1x

# 12

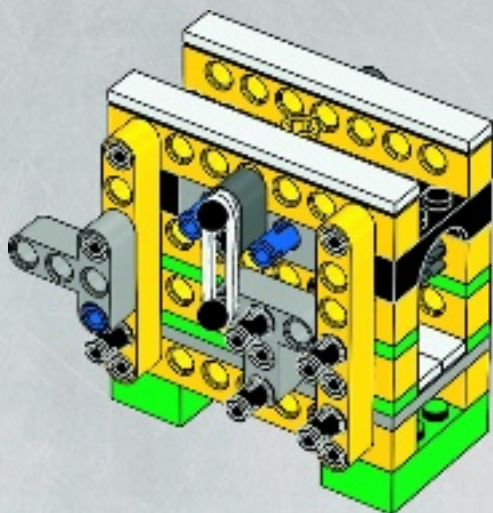

2x



1x

# 14

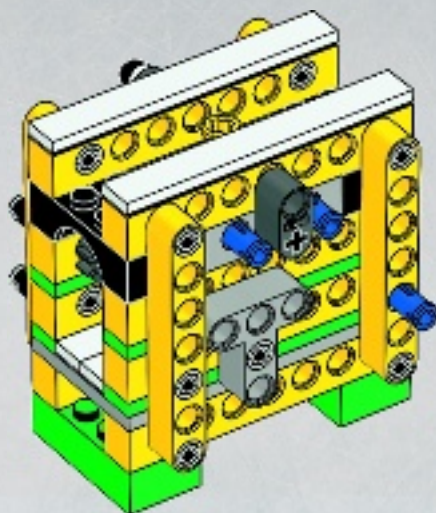

6x

2x

15

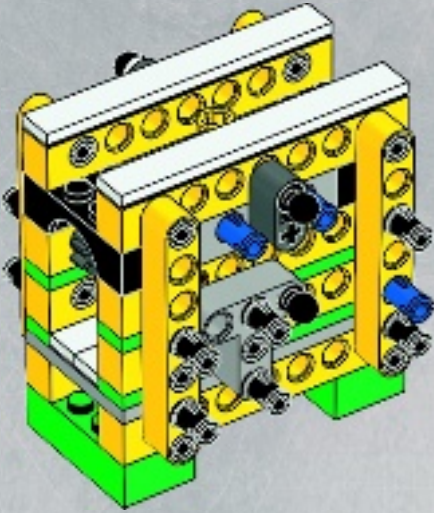

2x

2x

17

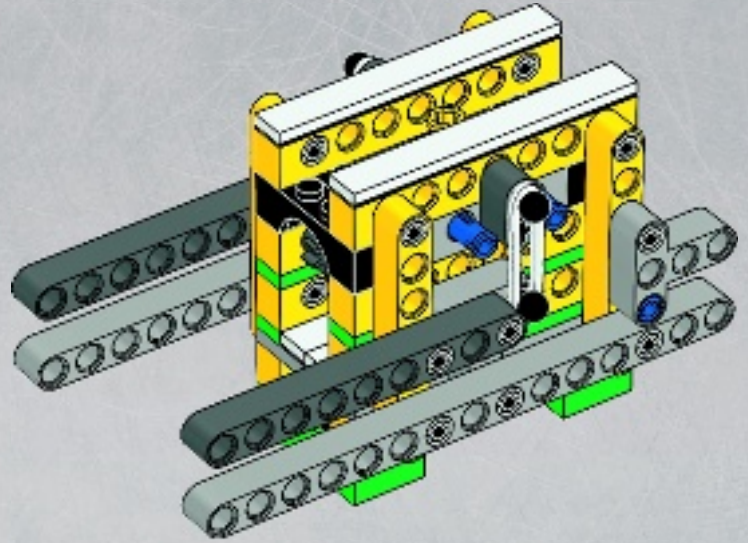

2x



1x

16

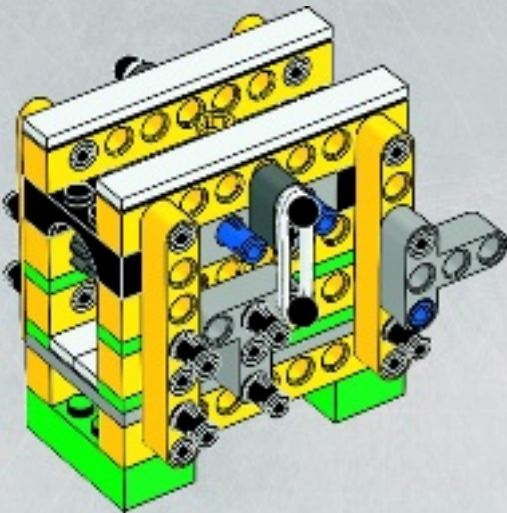

12x

18

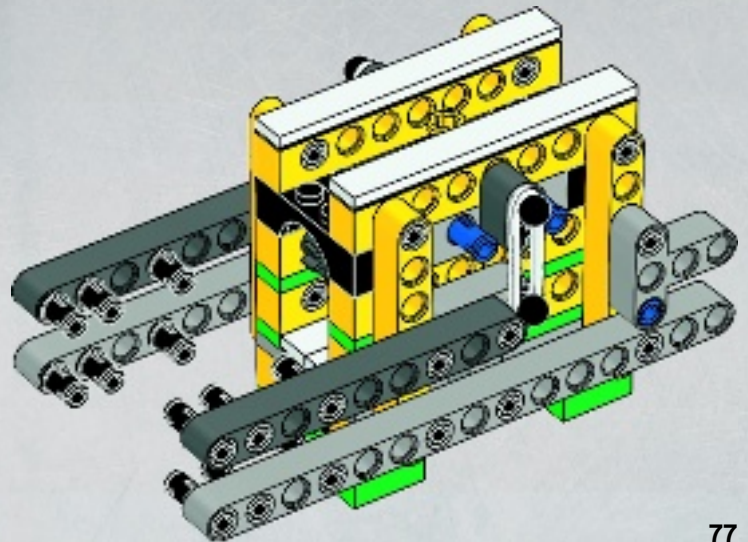

73

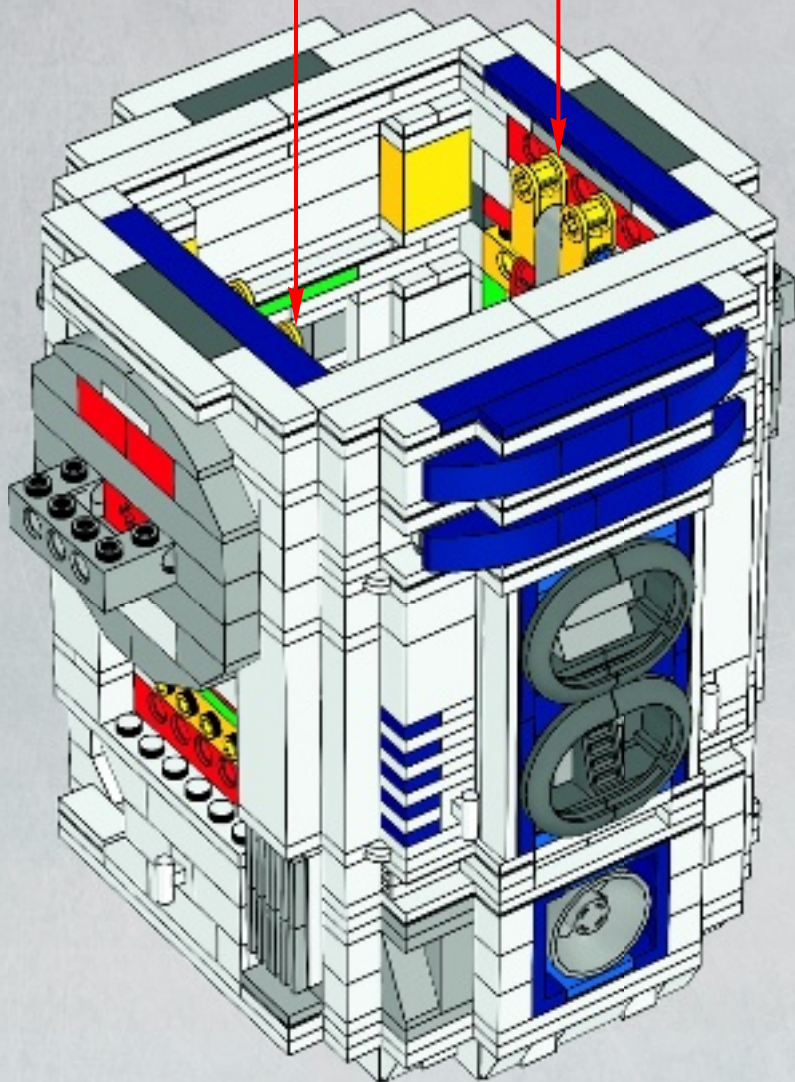
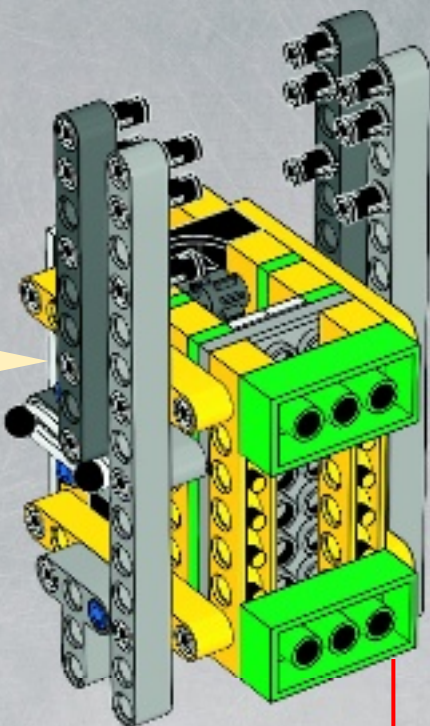



4x

# 74



4x

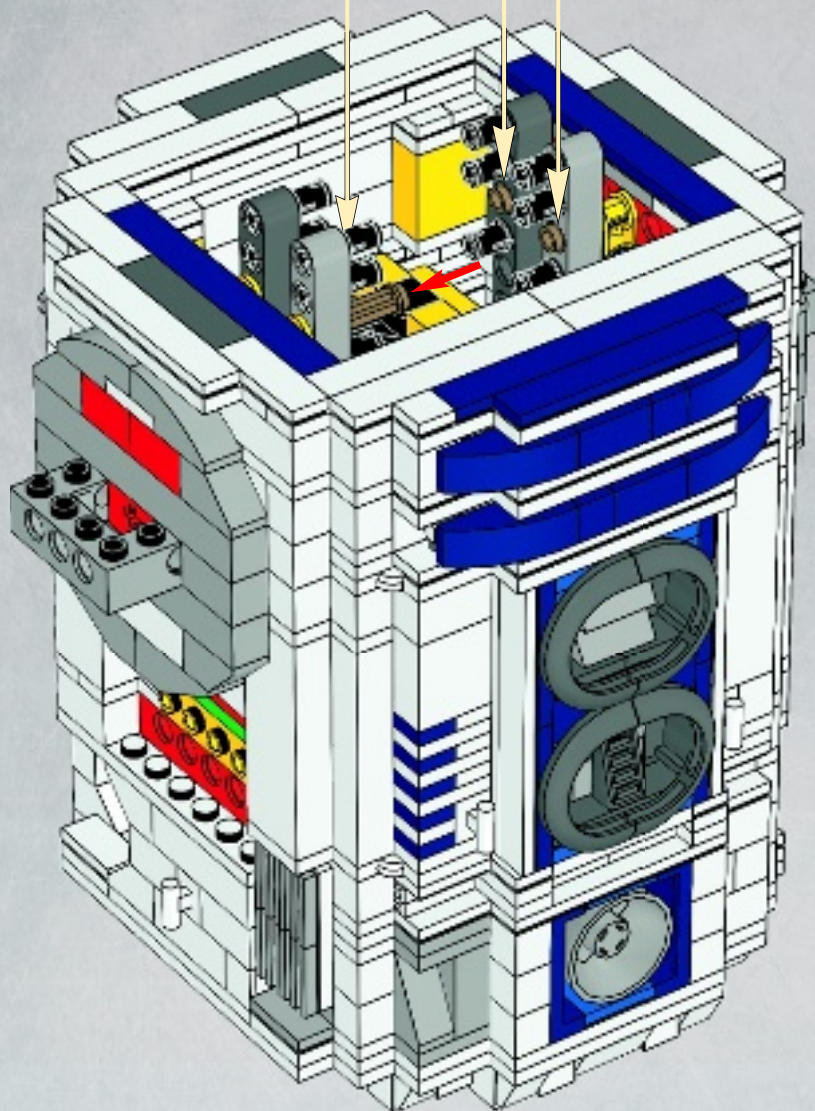



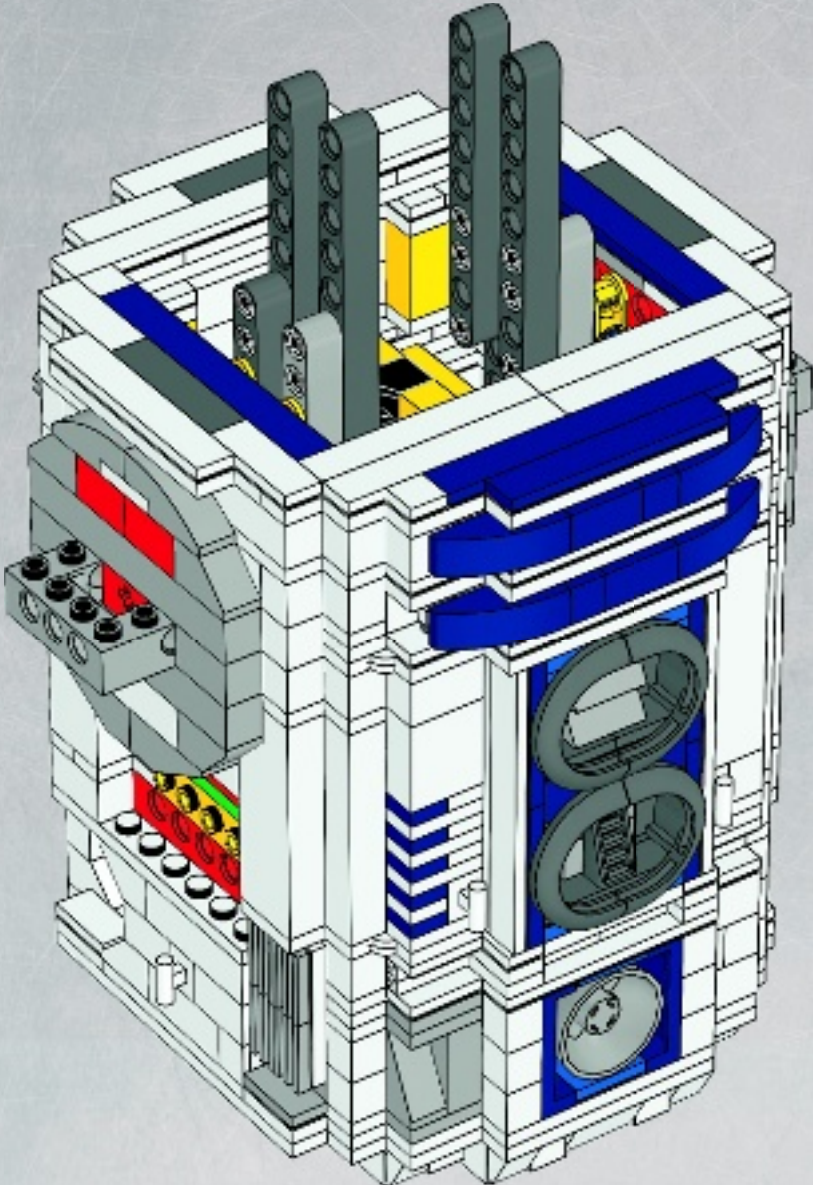

75





1x  ④ 1x 

 ④ 1:1

# 76

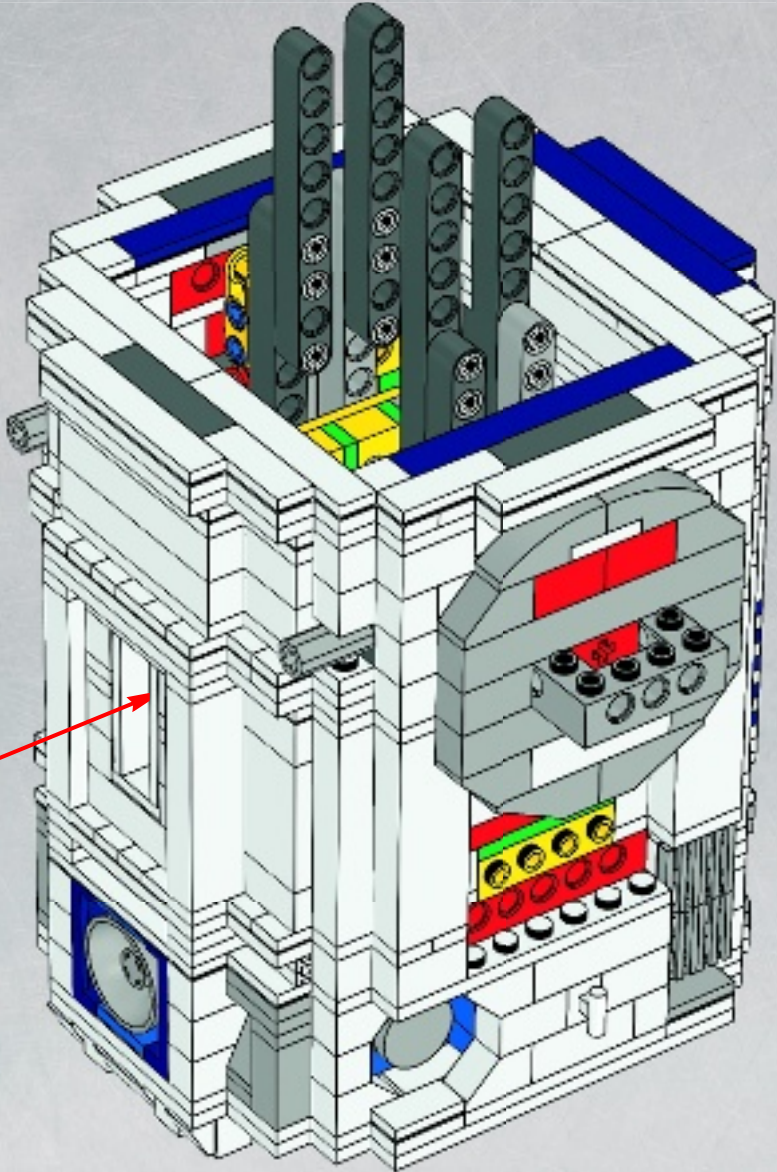
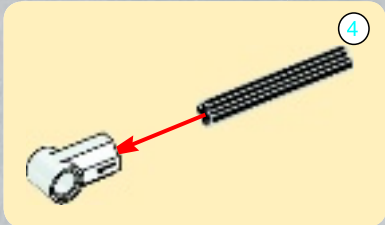



4x

# 77

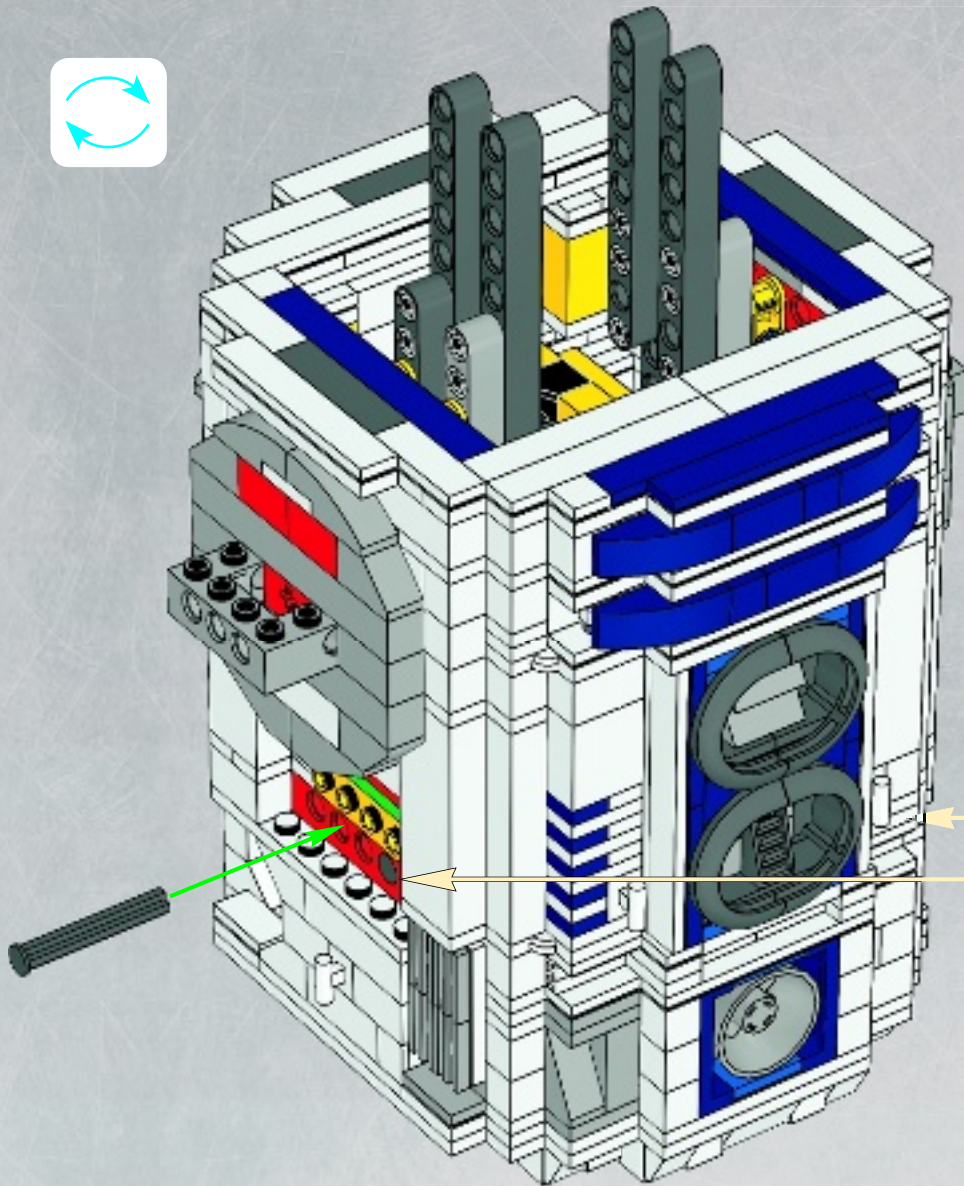

4x



2x

# 78

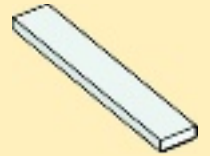
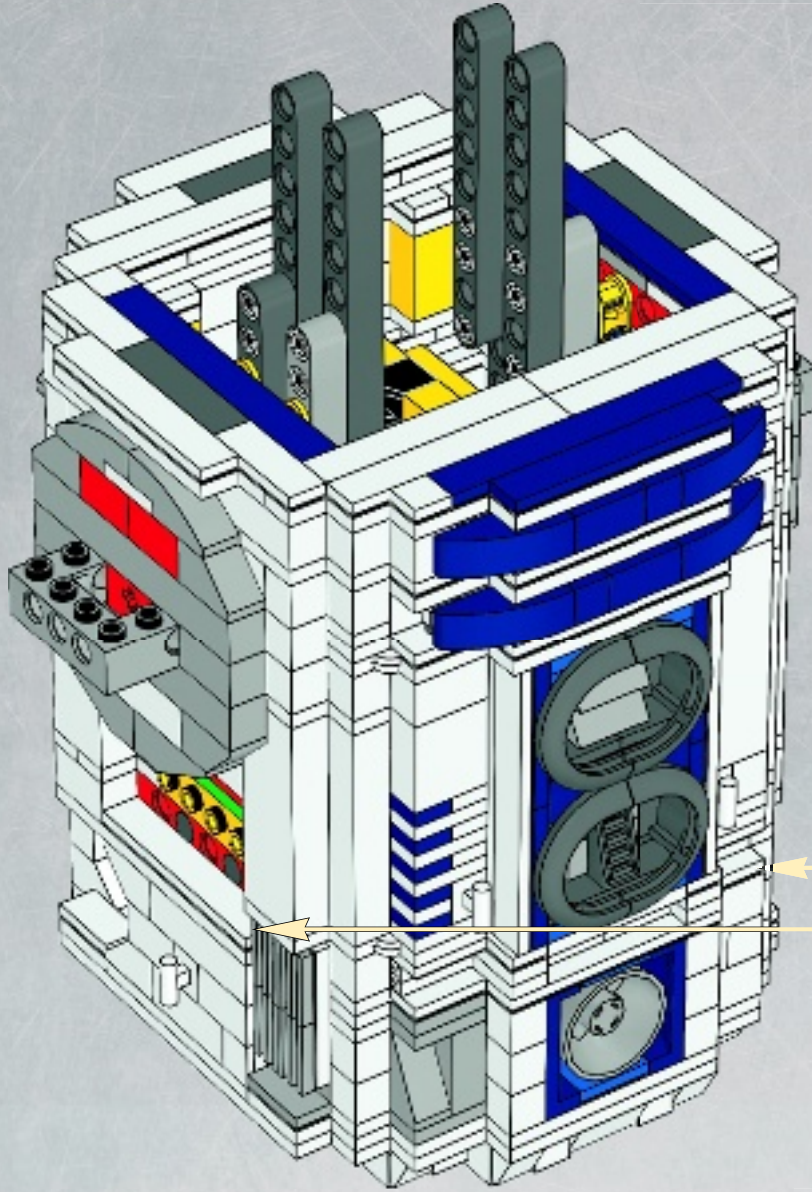

2x

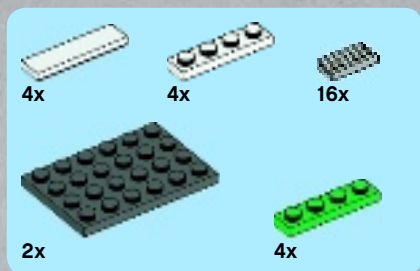

# 79

